



Event Report

Ulaanbaatar Grand Slam 2026, 19-21 Jun 2026

Event Report

454 competitors from 58 nations

253 Men

201 Women

55.73%

44.27%

-60 kg	-66 kg	-73 kg	-81 kg	-90 kg	-100 kg	+100 kg	Men
32	33	40	42	40	37	29	253

-48 kg	-52 kg	-57 kg	-63 kg	-70 kg	-78 kg	+78 kg	Women
29	29	29	28	33	28	25	201

Continent	AJU	JUA	EJU	OJU	PJC	OTH	Total
Nations	1	15	34	1	7		58
Competitors	6	184	244	5	15		454

Schedule	Day 1	Day 2	Day 3
Date	19 Jun	20 Jun	21 Jun
Start	09:30	09:30	09:30
End	14:55	14:51	14:53
Finals start	17:00	17:00	17:00
Finals end	19:50	20:30	19:46



Ulaanbaatar Grand Slam 2026

Mongolia, Ulaanbaatar, 19-21 Jun 2026

Men
Final results

-60 kg		
1	AGHAYEV Balabay	AZE
2	NAGAYAMA Ryuju	JPN
3	BYAMBASUREN Sukhbat	MGL
3	ASHPIZ Izhak	ISR
5	SARDALASHVILI Giorgi	GEO
5	YUSIFOV Ahmad	AZE
7	YANG Yung Wei	TPE
7	TUVSHINTUR Tumenjargal	MGL

-66 kg		
1	TAKEOKA Takeshi	JPN
2	ABDULAEV Ramazan	RUS
3	IMRANOV Nizami	AZE
3	KIM Channyeong	KOR
5	KAZIRBYEK Yolq	MGL
5	GARCIA TORNE David	ESP
7	PASHAYEV Ruslan	AZE
7	BATTOGTOKH Erkhembayar	MGL

-73 kg		
1	LAVJARGAL Ankhzaya	MGL
2	YONEZUKA Jack	USA
3	SKERLEV Victor	BUL
3	ODGEREL Uranbayar	MGL
5	GOGINASHVILI Irakli	GBR
5	ALOEVI Mukhamed	BRN
7	DOUKKALI Hassan	MAR
7	HRISTOV Mark	BUL

-81 kg		
1	LEE Joonhwan	KOR
2	OINO Yuhei	JPN
3	ARBUZOV Timur	RUS
3	SIMIN Mihajlo	SRB
5	GAUTHIER DRAPEAU Francois	CAN
5	CASSE Matthias	BEL
7	KAIROLLA Zhalgas	KAZ
7	IHANAMAKI Eetu	FIN

-90 kg		
1	MURAO Sanshiro	JPN
2	KIM Jonghoon	KOR
3	RUTOVIC Boris	SRB
3	FATYEV Murad	AZE
5	NGAYAP HAMBOU Maxime-Gael	FRA
5	KOPECKY Adam	CZE
7	TSELIDIS Theodoros	GRE
7	MAJDOV Nemanja	SRB

-100 kg		
1	PIRELLI Gennaro	ITA
2	BIFOV Idar	RUS
3	SULAMANIDZE Ilia	GEO
3	KOTSOIEV Zelym	AZE
5	KOSTOEV Dzhabar	UAE
5	ADAMIAN Arman	RUS
7	BAIKAMUROV Marat	KAZ
7	MASUCHI Ryotaro	JPN

+100 kg		
1	KIM Minjong	KOR
2	DEMETRASHVILI Irakli	GEO
3	SPIJKERS Jur	NED
3	TASOEV Inal	RUS
5	NASIBOV Kanan	AZE
5	KRPALEK Lukas	CZE
7	ENDOVITSKII Valerii	RUS
7	NAKANO Kanta	JPN



Ulaanbaatar Grand Slam 2026

Mongolia, Ulaanbaatar, 19-21 Jun 2026

Women Final results

-48 kg		
1	KOGA Wakana	JPN
2	ZHUANG Wenna	CHN
3	BEDER Tugce	TUR
3	MARTINEZ ABELENDA Laura	ESP
5	ERSIN Sila	TUR
5	PETIT Lois	BEL
7	BOUKLI Shirine	FRA
7	BURKEYEVA Diana	KAZ

-52 kg		
1	ABE Uta	JPN
2	GIUFFRIDA Odette	ITA
3	PUPP Reka	HUN
3	BISHRELT Khorloodoi	UAE
5	GYERTYAS Roza	HUN
5	TORO SOLER Ariane	ESP
7	BALLHAUS Mascha	GER
7	VAN KREVEL Naomi	NED

-57 kg		
1	OMORI Akari	JPN
2	CYSIQUE Sarah Leonie	FRA
3	BALLHAUS Seija	GER
3	PARDAYEVA Maysa	TKM
5	NELSON LEVY Timna	ISR
5	MOKDAR Faiza	FRA
7	VAN DE MEEBERG Shannon	NED
7	TERBISH Ariunzaya	MGL

-63 kg		
1	KAJU Haruka	JPN
2	VAN LIESHOUT Joanne	NED
3	LILUASHVILI Dali	RUS
3	PIOVESANA Lubjana	AUT
5	LKHAGVATOGOO Enkhriilen	MGL
5	BAUER Sara-Joy	GER
7	GALITSKAIA Kseniia	RUS
7	AVANZATO Carlotta	ITA

-70 kg		
1	TANAKA Shiho	JPN
2	COUGHLAN Aoife	AUS
3	VAN DIJKE Sanne	NED
3	CVJETKO Lara	CRO
5	DE VOOGD Margit	NED
5	BUTKEREIT Miriam	GER
7	GOSHEN Maya	ISR
7	EME Clemence	FRA

-78 kg		
1	LYTVYNENKO Yelyzaveta	UAE
2	TCHEUMEO Audrey	FRA
3	BOEHM Alina	GER
3	OLAYA Brenda	COL
5	OLEK Anna Monta	GER
5	VAN HEEMST Yael	NED
7	LOBNIK Metka	SLO
7	PAVIC Petrunjela	CRO

+78 kg		
1	ARAI Mao	JPN
2	DICKO Romane	FRA
3	TAVANO Asya	ITA
3	CANCAN Celia	FRA
5	VUKOVIC Helena	CRO
5	AKTAS Emma-Melis	EST
7	HERSHKO Raz	ISR
7	MISHINER Yuli Alma	ISR



Medals

Ulaanbaatar Grand Slam 2026, 19-21 Jun 2026

Medals

Nations: 24

#	Nation	1. Place	2. Place	3. Place	5. Place	7. Place
1.	JPN Japan	8	2			2
2.	KOR Republic of Korea	2	1	1		
3.	ITA Italy	1	1	1		1
4.	AZE Azerbaijan	1		3	2	1
5.	MGL Mongolia	1		2	2	3
6.	UAE United Arab Emirates	1		1	1	
7.	FRA France		3	1	2	2
8.	RUS Russian Federation		2	3	1	2
9.	NED Netherlands		1	2	2	2
10.	GEO Georgia		1	1	1	
11.	AUS Australia		1			
11.	CHN People's Republic of China		1			
11.	USA United States of America		1			
14.	GER Germany			2	3	1
15.	SRB Serbia			2		1
16.	ESP Spain			1	2	
17.	ISR Israel			1	1	3
18.	CRO Croatia			1	1	1
19.	HUN Hungary			1	1	
19.	TUR Türkiye			1	1	
21.	BUL Bulgaria			1		1
22.	AUT Austria			1		
22.	COL Colombia			1		
22.	TKM Turkmenistan			1		
25.	BEL Belgium				2	
25.	CZE Czechia				2	
27.	BRN Bahrain				1	
27.	CAN Canada				1	
27.	EST Estonia				1	
27.	GBR Great Britain				1	
31.	KAZ Kazakhstan					3
32.	TPE Chinese Taipei					1
32.	FIN Finland					1
32.	GRE Greece					1
32.	MAR Morocco					1
32.	SLO Slovenia					1

Official person:



Statistics

Ulaanbaatar Grand Slam 2026, 19-21 Jun 2026

Statistics

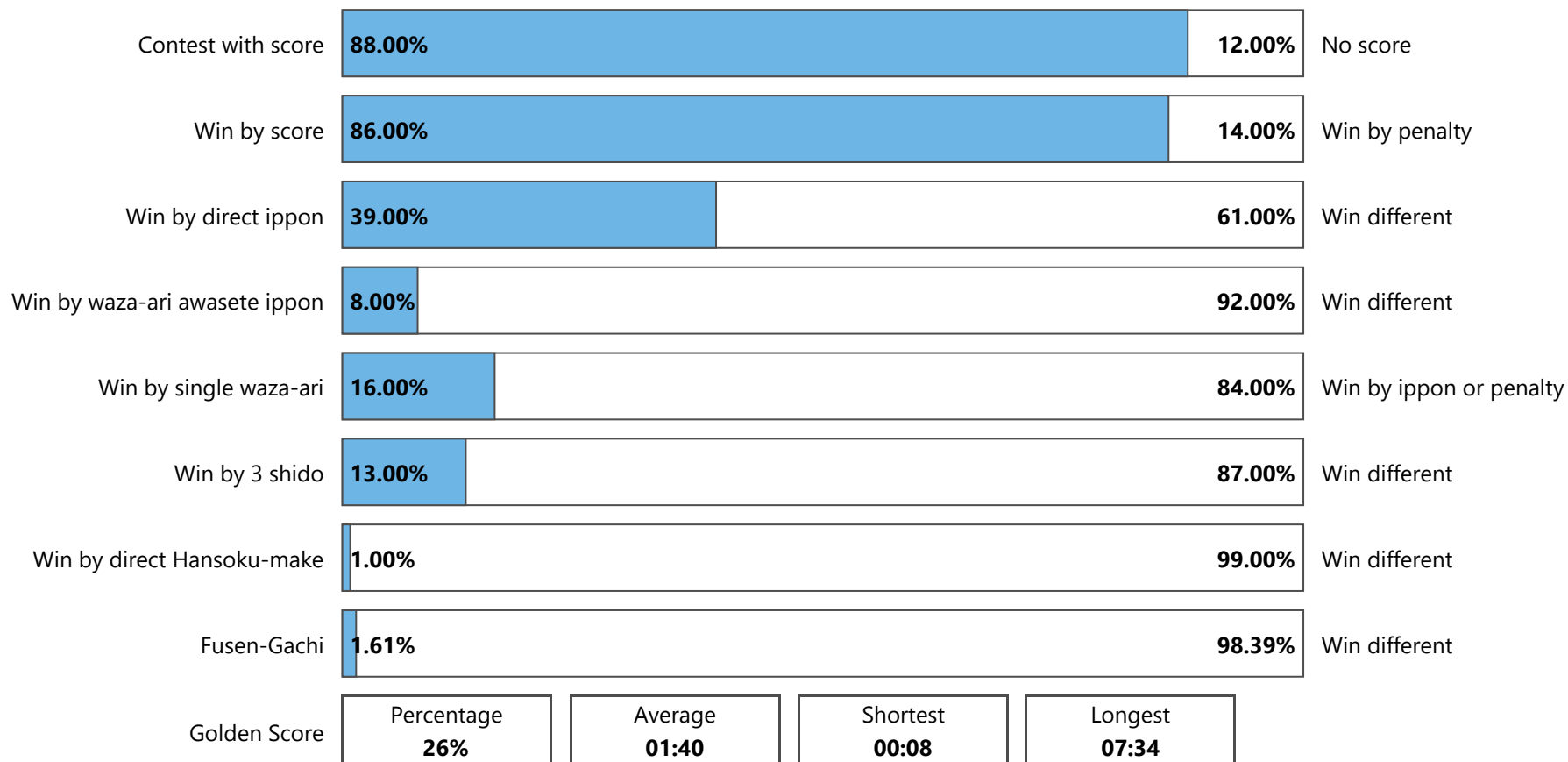



Statistics

Ulaanbaatar Grand Slam 2026, 19-21 Jun 2026

Statistics

	-60	-66	-73	-81	-90	-100	+100	M	-48	-52	-57	-63	-70	-78	+78	W	Total
Competitors	32	33	40	42	40	37	29	253	29	29	29	28	33	28	25	201	454
Contests	35	36	43	45	43	40	32	274	32	32	32	31	36	31	28	222	496
Wins by Score	32	33	37	40	39	34	24	239	31	28	29	25	29	26	21	189	428
Wins by Score %	91	92	86	89	91	85	75	87.23	97	88	91	81	81	84	75	85.14	86
Wins by Penalty	3	3	6	5	4	6	8	35	1	4	3	6	7	5	7	33	68
Wins by Penalty %	9	8	14	11	9	15	25	12.77	3	12	9	19	19	16	25	14.86	14
Wins by direct Ippon %	31	44	37	58	49	42	31	42.70	38	41	31	35	33	35	29	34.68	39
Wins by Waza-ari Awasete Ippon %	6	6	2	0	9	10	9	5.84	9	3	9	13	8	6	21	9.91	8
Wins by Waza-ari %	23	22	16	20	14	22	16	18.98	9	28	9	10	6	13	11	12.16	16
Wins by Yuko %	31	19	30	11	19	10	19	19.71	41	16	41	23	33	29	14	28.38	24
Wins by 3 Shido for opponent %	0	8	14	11	9	15	25	11.68	3	12	9	19	19	16	21	14.41	13
Wins by direct Hansoku-make %	9	0	0	0	0	0	0	0	0	0	0	0	0	0	4	0	1
Double HSK %	0	0	0	0	0	0	0	0	0	0	0	0	0	0	0	0	0
All positive Scores (Yuko + Waza-ari + direct Ippon)	56	52	57	56	64	49	38	372	55	37	40	40	43	47	32	294	666
Average Scores per contests	9	8	14	11	9	15	25	1.36	3	12	9	19	19	16	25	1.32	14
Contests with score %	94	92	86	91	91	85	78	88.32	97	91	91	84	83	87	82	87.84	88
All penalties (Shido + HSK)	68	70	94	73	85	72	80	542	46	64	61	54	77	71	65	438	980
Average penalty per contest	1.94	1.94	2.19	1.62	1.98	1.8	2.5	1.98	1.44	2	1.91	1.74	2.14	2.29	2.32	1.97	1.98
Contests with only penalty %	6	8	14	9	9	15	22	11.68	3	9	9	16	17	13	18	12.16	12
Number of Osae-komi (Absolute)	9	8	15	9	11	8	9	69	10	4	8	9	9	11	12	63	132
Osae-komi no score %	44.44	25.00	60.0	22.22	18.18	37.50	22.22	34.78	40.0	25.00	50.0	33.33	33.33	27.27	25.00	33.33	34.09
Osae-komi Yuko %	11.11	25.00	20.0	11.11	18.18	0	33.33	4.38	20.0	25.00	12.50	0	0	18.18	25.00	4.05	15.91
Osae-komi Waza-ari %	11.11	12.50	0	11.11	27.27	37.50	22.22	4.01	20.0	25.00	25.00	33.33	44.44	18.18	33.33	8.11	21.97
Osae-komi Ippon %	33.33	37.50	20.0	55.56	36.36	25.00	22.22	8.03	20.0	25.00	12.50	33.33	22.22	36.36	16.67	6.76	28.03
Direct Hansoku-make	3	0	0	0	0	0	0	3	0	0	0	0	0	0	1	1	4
Fusen-gachi	1	0	1	1	0	2	0	5	0	1	0	0	1	0	1	3	8
Doctor call	0	0	0	0	0	0	0	0	0	0	0	0	0	0	0	0	0
Golden Score %	17	33	47	24	26	28	19	28.10	19	31	28	26	25	13	25	23.87	26
Golden Score Duration AVG	104	112.58	110.8	77.82	122.91	83.64	78	101.13	116.67	134.7	86	88.12	111.11	78.75	60.57	99.34	100.4
Golden Score Duration MAX	262	373	268	127	454	204	264	454	289	271	187	204	234	152	110	289	454



Nations Overview

Ulaanbaatar Grand Slam 2026, 19-21 Jun 2026

Nations

Overview

			-60	-66	-73	-81	-90	-100	+10	M	-48	-52	-57	-63	-70	-78	+78	W	Total	Ref	D	
1.		AUS	Australia	1					1	2		1			1	1		3	5	1	1	
2.		AUT	Austria				1	1	1	3				1	1	1		3	6	0	3	
3.		AZE	Azerbaijan	2	2	2	1	2	1	2	12	1	1		1	1	1	5	17	1	13	
4.		BEL	Belgium			1	1			2	1						1	2	4	0	3	
5.		BLR	Belarus				1	1		2				1		1		2	4	0	2	
6.		BRN	Bahrain	1		1	1	1		4								0	4	0	1	
7.		BUL	Bulgaria		1	2	2		1	6		1		1				2	8	0	2	
8.		CAN	Canada		1	1	1		1	4		1				1		2	6	0	2	
9.		CHI	Chile							0	1							1	1	0	1	
10.		CHN	People's Republic of China	1	1	1		1	1	1	6	1		2			1	2	6	12	0	6
11.		COL	Colombia							0						1		1	1	0	1	
12.		CRO	Croatia						1	1	2			2	1	1	2	6	8	0	3	
13.		CYP	Cyprus		1				1	1	3		1			1		2	5	0	1	
14.		CZE	Czechia			1		1		1	3			1				1	4	1	3	
15.		DEN	Denmark			1				1	1							0	1	0	1	
16.		ESP	Spain		1				1	2	1	1			1			3	5	0	4	
17.		EST	Estonia					1	1	2						1		1	3	0	2	
18.		FIN	Finland		1	1	1		1	4			2			1		3	7	0	2	
19.		FRA	France	1	1	1	1	2	1	1	8	1	1	2	1	1	2	2	10	18	1	11
20.		GBR	Great Britain			1				1	1		1					1	2	0	1	
21.		GEO	Georgia	1	2	2	1	1	1	1	9	1			2		1	4	13	0	7	
22.		GER	Germany							0		1	1	2	2	2	1	9	9	0	3	
23.		GRE	Greece				2	1		3								0	3	0	1	
24.		HUN	Hungary						1	1		2						2	3	1	2	
25.		IND	India		1		1			2								0	2	0	0	
26.		IRL	Ireland			1		1		2								0	2	0	1	
27.		ISR	Israel	1		1	1	2	1	6	1	1	2	1	2		2	9	15	0	6	
28.		ITA	Italy	2	2	2	2	2	2	12	2	1	1	2	2		1	9	21	1	8	
29.		JPN	Japan	1	1	1	1	1	1	1	7	1	1	1	1	1	1	7	14	1	30	
30.		KAZ	Kazakhstan	2	2	2	2	2	1	11	2	1	2	2			2	9	20	0	7	
31.		KGZ	Kyrgyzstan		1	1	2	1		5								0	5	0	1	
32.		KOR	Republic of Korea	2	2	1	2	2	2	2	13	2	2	2	2	2		10	23	1	7	
33.		LTU	Lithuania							0						1		1	1	0	1	
34.		MAR	Morocco	1	1	1			1	4		1		1				2	6	0	2	
35.		MAS	Malaysia				1			1								0	1	0	1	
36.		MGL	Mongolia	4	4	4	4	4	4	4	28	4	4	4	4	4	4	28	56	1	15	
37.		NED	Netherlands	1				2	1	1	5	1	1	1	1	2	2	8	13	0	4	
38.		PHI	Philippines	1	1					2								0	2	0	0	
39.		POL	Poland				1	1	2	1	5		1		1			2	7	0	4	
40.		POR	Portugal		1					1	1							1	2	0	1	
41.		PUR	Puerto Rico				1			1								0	1	0	1	
42.		ROU	Romania			1	1	1	2	1	6					1		1	7	1	3	
43.		RUS	Russian Federation	2	2	2	1	2	2	2	13	2	1	2	2	1	1	2	11	24	0	24
44.		SLO	Slovenia	1						1					2	1		3	4	0	2	
45.		SRB	Serbia				2	2	2	6						1		1	7	0	4	



Nations Overview

Ulaanbaatar Grand Slam 2026, 19-21 Jun 2026

Nations

Overview

			-60	-66	-73	-81	-90	-100	+10	M	-48	-52	-57	-63	-70	-78	+78	W	Total	Ref	D
46.	SUI	Switzerland				1		1		2								0	2	0	1
47.	SVK	Slovakia					1	1	1	3					1			1	4	0	2
48.	SWE	Sweden						1		1					2			2	3	0	1
49.	TKM	Turkmenistan	2	1	2	2	1	2		10	1	1	2		2			6	16	0	10
50.	TPE	Chinese Taipei	1	1			1		1	4	1	1	1	1	1	1	2	8	12	0	16
51.	TUR	Türkiye			1				1	2	2		2		1	1		6	8	0	4
52.	UAE	United Arab Emirates	1	1	2	2	1	1	1	9		1				1		2	11	0	4
53.	UKR	Ukraine	2			1		1		4								0	4	0	2
54.	URU	Uruguay								0			1					1	1	0	0
55.	USA	United States of America			2	1	1			4								0	4	0	0
56.	UZB	Uzbekistan	1	1						2								0	2	0	1
57.	VEN	Venezuela			1					1								0	1	0	0
58.	VIE	Vietnam								0	2	2						4	4	0	2
			32	33	40	42	40	37	29	253	29	29	29	28	33	28	25	201	454	10	241

Total: 454 competitors from 58 countries and 5 continents



Ulaanbaatar Grand Slam 2026

Mongolia, Ulaanbaatar, 19-21 Jun 2026

-60 kg

Men (32)

POOL A

	AGHAYEV Balabay	AZE
	LESIUK Artem	UKR
	KATZ Joshua	AUS
	RAMAZANOV Mekan	TKM
	SARDALASHVILI Giorgi	GEO
	STARKEL David	SLO
	ENKHTAIVAN Ariunbold	MGL
	BAKYTZHAN Aman	KAZ

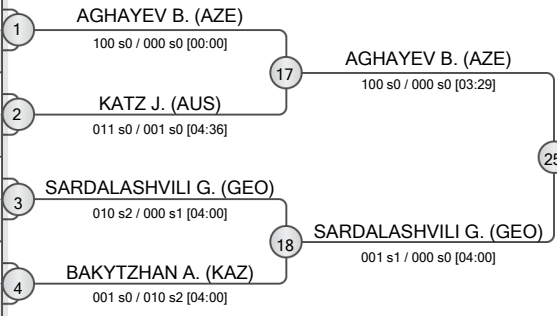

POOL B

	ASHPIZ Izhak	ISR
	JARING Emiel	NED
	NAKANO Shugen	PHI
	HWANG Hyesung	KOR
	YANG Yung Wei	TPE
	NYAMSUREN Mendsaikhan	MGL
	KOTELNIKOV Dmitrii	RUS
	CARLINO Andrea	ITA

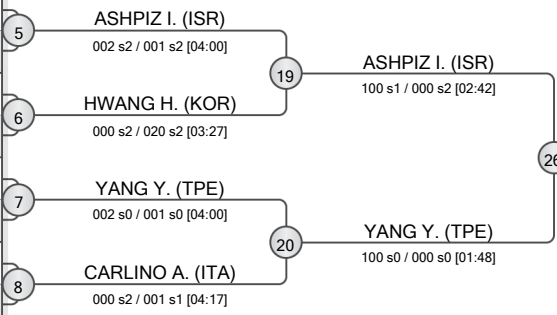

POOL C

	YUSIFOV Ahmad	AZE
	SIMEONIDIS Konstantin	UAE
	SHAMSHADIN Magzhan	KAZ
	D ANGELO Biagio	ITA
	BYAMBASUREN Sukhbat	MGL
	SUN Jiahao	CHN
	LEE Harim	KOR
	RUZIEV Doston	UZB

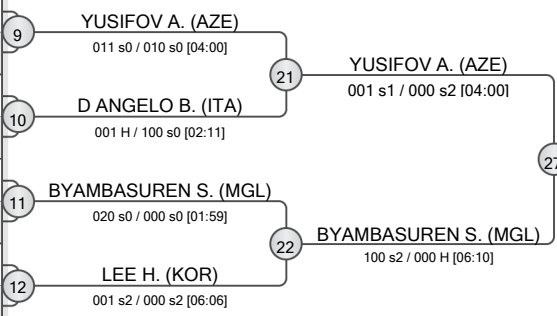

POOL D

	MKHEIDZE Luka	FRA
	POLTORATSKII Ruslan	BRN
	ALAOUI CHERIFI Ahmed	MAR
	TUVSHINTUR Tumenjargal	MGL
	NAGAYAMA Ryuju	JPN
	KHALMATOV Dilshot	UKR
	DOMBUU Achty	RUS
	BAHTIYAROV Ural	TKM

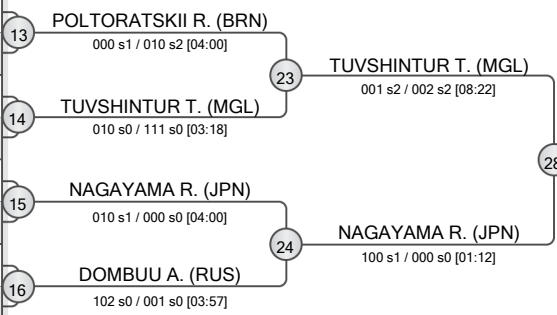

REPECHAGE

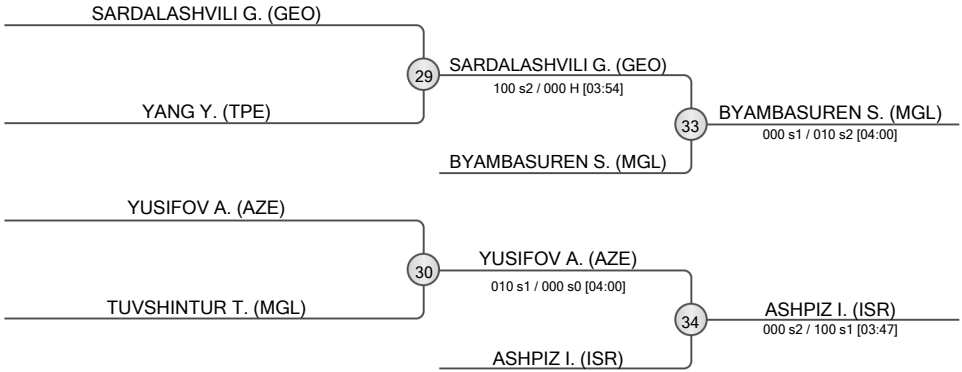

FINAL RESULTS		
1.	AGHAYEV Balabay	AZE
2.	NAGAYAMA Ryuju	JPN
3.	BYAMBASUREN Sukhbat	MGL
3.	ASHPIZ Izhak	ISR
5.	SARDALASHVILI Giorgi	GEO
7.	YANG Yung Wei	TPE
7.	TUVSHINTUR Tumenjargal	MGL





Ulaanbaatar Grand Slam 2026

Mongolia, Ulaanbaatar, 19-21 Jun 2026

-66 kg

Men (33)

POOL A

1	PASHAYEV Ruslan (AZE)	1	PASHAYEV R. (AZE)
2	TUMURKHUU Turbold (MGL)	33	PASHAYEV R. (AZE) 100 s1 / 000 s0 [06:00]
3	JEON Seungbeom (KOR)	3	JEON S. (KOR)
4	SERIKBAYEV Nurkanat (KAZ)	34	SERIKBAYEV N. (KAZ) 001 s0 / 020 s1 [03:22]
5	ABDULAEV Ramazan (RUS)	5	ABDULAEV R. (RUS)
6	MARGVELASHVILI Vazha GEO GAGO Miguel POR	35	ABDULAEV R. (RUS) 100 s0 / 000 s0 [00:41]
7	AIBEK UULU Kubanychbek (KGZ)	7	AIBEK UULU K. (KGZ)
8	ORTIKOV Azizbek (UZB)	36	ORTIKOV A. (UZB) 000 s2 / 001 s1 [05:53]

POOL B

9	CHOPANOV Murad (RUS)	9	CHOPANOV M. (RUS)
10	FRASCADORE Julien (CAN)	37	CHOPANOV M. (RUS) 100 s1 / 000 s1 [03:36]
11	KAZIRBYEK Yolc (MGL)	11	KAZIRBYEK Y. (MGL)
12	BOUSHITA Abderrahmane (MAR)	38	KAZIRBYEK Y. (MGL) 100 s0 / 000 s0 [02:26]
13	GARCIA TORNE David (ESP)	13	GARCIA TORNE D. (ESP)
14	XUE Ziyang (CHN)	39	GARCIA TORNE D. (ESP) 100 s1 / 000 s3 [06:21]
15	PIRAS Matteo (ITA)	15	PIRAS M. (ITA)
16	RAHIMOV Serdar (TKM)	40	RAHIMOV S. (TKM) 000 s2 / 001 s2 [05:28]

POOL C

17	TAKEOKA Takeshi (JPN)	17	TAKEOKA T. (JPN)
18	ACCOGLI Valerio (ITA)	41	TAKEOKA T. (JPN) 020 s1 / 000 s1 [02:19]
19	NAKANO Keisei (PHI)	19	NAKANO K. (PHI)
20	CHRISTODOULIDES Petros (CYP)	42	CHRISTODOULIDES P. (CYP) 000 s2 / 011 s0 [04:00]
21	BOUBA Daikii (FRA)	21	BOUBA D. (FRA)
22	BATTOGTOKH Erkhembayar (MGL)	43	BATTOGTOKH E. (MGL) 001 s1 / 100 s0 [03:23]
23	YOTOV Boyan (BUL)	23	YOTOV B. (BUL)
24	NASSYR Akzhigit (KAZ)	44	NASSYR A. (KAZ) 001 s1 / 101 s1 [04:51]

POOL D

25	KIM Channyeong (KOR)	25	KIM C. (KOR)
26	BAYANMUNKH Narmandakh (UAE)	45	KIM C. (KOR) 010 s1 / 000 s2 [07:04]
27	UNURBAT Jantsandorj (MGL)	27	UNURBAT J. (MGL)
28	LIN Chong-You (TPE)	46	LIN C. (TPE) 000 s0 / 100 s1 [01:16]
29	SAHA Luukas (FIN)	29	SAHA L. (FIN)
30	GIGAURI Tornike (GEO)	47	GIGAURI T. (GEO) 000 s1 / 100 s1 [00:57]
31	MAJGUL Rohit Basir (IND)	31	MAJGUL R. (IND)
32	IMRANOV Nizami (AZE)	48	IMRANOV N. (AZE) 000 s3 / 100 s0 [05:48]

REPECHAGE

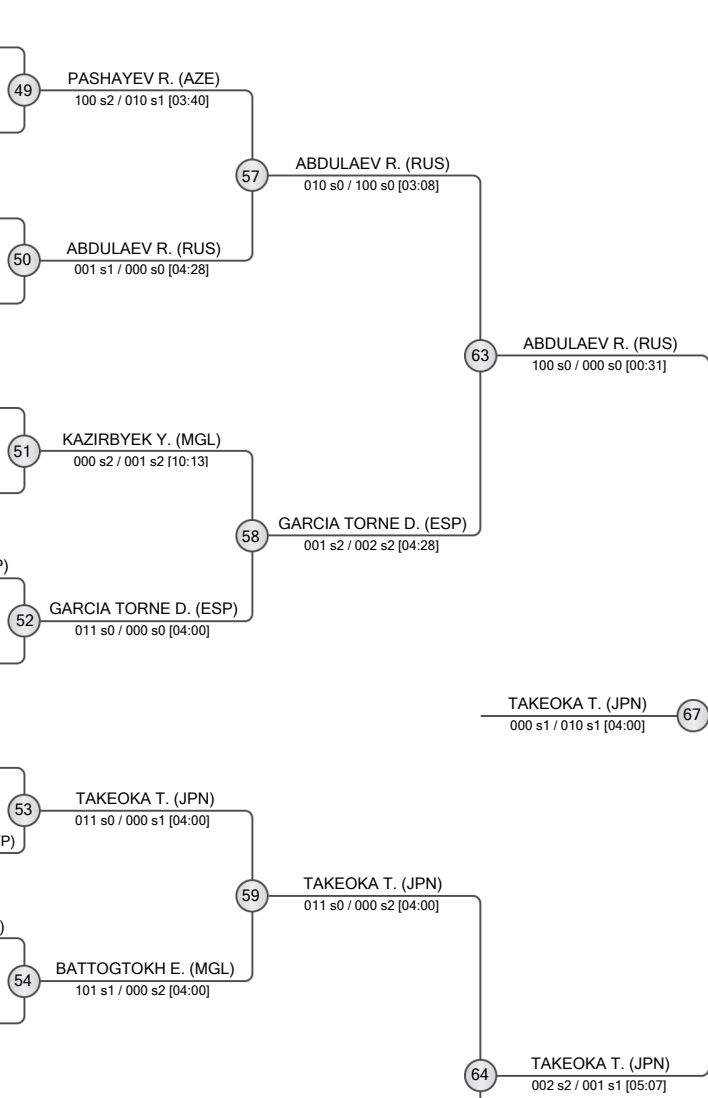
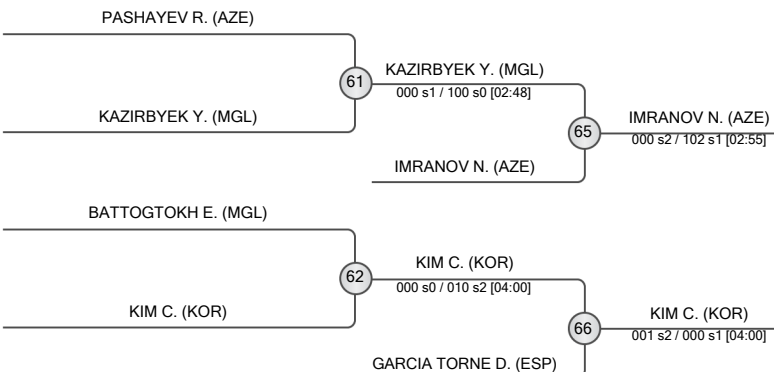

FINAL RESULTS		
1.	TAKEOKA Takeshi	JPN
2.	ABDULAEV Ramazan	RUS
3.	IMRANOV Nizami	AZE
3.	KIM Channyeong	KOR
5.	KAZIRBYEK Yolc	MGL
5.	GARCIA TORNE David	ESP
7.	PASHAYEV Ruslan	AZE
7.	BATTOGTOKH Erkhembayar	MGL





Ulaanbaatar Grand Slam 2026

Mongolia, Ulaanbaatar, 19-21 Jun 2026

-73 kg

Men (40)

POOL A

MAKHMADBEKOV Makhmadbek UAE	1	MAKHMADBEKOV M. (UAE)	33	LOMBARDO M. (ITA)	000 s1 / 100 s1 [04:12]
LOMBARDO Manuel ITA	2	LOMBARDO M. (ITA)			
AN Jaehong KOR	3	AN J. (KOR)	001 s2 / 000 s1 [05:14]	SKERLEV V. (BUL)	000 s3 / 100 s1 [03:40]
TERASHVILI Giorgi GEO	4	SKERLEV V. (BUL)	34	SKERLEV V. (BUL)	000 s3 / 100 s2 [05:33]
SKERLEV Victor BUL					
ODGEREL Uranbayar MGL	5	ODGEREL U. (MGL)			
KARIMOV Chusniddin CZE	6	KARIMOV C. (CZE)	001 s0 / 000 s0 [04:00]	ODGEREL U. (MGL)	100 s1 / 000 s1 [01:30]
PARICHE Andres VEN	7	GALSTIAN K. (RUS)	36	GALSTIAN K. (RUS)	101 s0 / 000 s0 [02:35]
GALSTIAN Karen RUS					
OLIN Valtteri FIN	8	OLIN V. (FIN)			

POOL B

MAMMADALIYEV Rashid AZE	9	MAMMADALIYEV R. (AZE)	37	DOUKKALI H. (MAR)	000 s1 / 001 s2 [04:27]
DOUKKALI Hassan MAR	10	DOUKKALI H. (MAR)			
LKHAMAA Enkhdul MGL	11	ZHANG M. (CHN)	002 s0 / 100 s0 [02:55]	SHAMURADOV M. (TKM)	000 s1 / 100 s0 [01:15]
ZHANG Minghao CHN	12	SHAMURADOV M. (TKM)	38	SHAMURADOV M. (TKM)	
SHAMURADOV Meylis TKM					
YONEZUKA Jack USA	13	YONEZUKA J. (USA)	39	YONEZUKA J. (USA)	001 s2 / 000 s2 [08:18]
GREEN Joshua IRL	14	GREEN J. (IRL)			
DZITAC Ioan ROU	15	BOULEMTAFES D. (FRA)	40	BOULEMTAFES D. (FRA)	010 s0 / 000 s1 [04:00]
BOULEMTAFES Dayyan FRA					
GAINULLIN Angsarbek KAZ	16	GAINULLIN A. (KAZ)			

POOL C

HEYDAROV Hidayat AZE	17	HEYDAROV H. (AZE)	41	ALTAIBAATAR U. (MGL)	000 s0 / 100 s0 [00:00]
ALTAIBAATAR Usukhjargal MGL	18	ALTAIBAATAR U. (MGL)			
ESPOSITO Giovanni ITA	19	ESPOSITO G. (ITA)	003 s0 / 000 s1 [04:00]	HRISTOV M. (BUL)	000 s1 / 001 s2 [05:11]
BAKIRDINOV Nurmukhammed KGZ	20	HRISTOV M. (BUL)	42	HRISTOV M. (BUL)	
HRISTOV Mark BUL					
SHAVDATUASHVILI Lasha GEO	21	SHAVDATUASHVILI L. (GEO)	43	SHAVDATUASHVILI L. (GEO)	100 s2 / 000 s2 [06:57]
LEMIRE Justin CAN	22	LEMIRE J. (CAN)	100 s1 / 000 s1 [01:04]	GOGINASHVILI I. (GBR)	000 s3 / 100 s2 [04:26]
ELBAZ Yehonatan ISR	23	GOGINASHVILI I. (GBR)	44	GOGINASHVILI I. (GBR)	100 s1 / 000 s0 [02:53]
GOGINASHVILI Irakli GBR					
BOLDBAATAR Steven USA	24	BOLDBAATAR S. (USA)			

POOL D

LAVRENTEV Danil RUS	25	LAVRENTEV D. (RUS)	45	LAVRENTEV D. (RUS)	010 s1 / 001 s0 [04:00]
AMANSAHEDOV Ulaman TKM	26	TANAKA R. (JPN)	000 s0 / 102 s1 [03:00]	ALOE V. M. (BRN)	000 s1 / 001 s0 [04:25]
TANAKA Ryuga JPN	27	ALOE V. M. (BRN)	46	ALOE V. M. (BRN)	021 s0 / 000 s1 [01:59]
ALOE V. Mukhamed BRN					
ERRBOE Morgan DEN	28	ERRBOE M. (DEN)			
LAVJARGAL Ankhzaya MGL	29	LAVJARGAL A. (MGL)	47	LAVJARGAL A. (MGL)	010 s1 / 000 s0 [04:00]
NAGUCHEV Kazbek UAE	30	NAGUCHEV K. (UAE)	102 s0 / 000 s0 [04:00]	LAVJARGAL A. (MGL)	100 s1 / 000 s3 [06:12]
CILOGLU Bilal TUR	31	KUANOV Y. (KAZ)	48	KUANOV Y. (KAZ)	011 s1 / 000 s2 [04:00]
KUANOV Yesset KAZ					
UMAYEV Abdul Malik BEL	32	UMAYEV A. (BEL)			

REPECHAGE

SKERLEV V. (BUL)		61	SKERLEV V. (BUL)	102 s0 / 000 s0 [01:51]			
DOUKKALI H. (MAR)					65		
					SKERLEV V. (BUL)	010 s2 / 000 s2 [08:28]	
					GOGINASHVILI I. (GBR)		
HRISTOV M. (BUL)		62	ALOE V. M. (BRN)	010 s1 / 011 s1 [05:31]			
ALOE V. M. (BRN)					66	ODGEREL U. (MGL)	000 s3 / 100 s1 [05:52]
					ODGEREL U. (MGL)		

63	YONEZUKA J. (USA)	000 s2 / 001 s2 [05:38]
64	LAVJARGAL A. (MGL)	000 s2 / 010 s1 [06:28]
65	YONEZUKA J. (USA)	000 s1 / 101 s0 [03:35]
66	YONEZUKA J. (USA)	001 s2 / 000 s1 [04:00]
67	LAVJARGAL A. (MGL)	000 s2 / 100 s1 [08:17]

FINAL RESULTS

- LAVJARGAL Ankhzaya MGL
- YONEZUKA Jack USA
- SKERLEV Victor BUL
- ODGEREL Uranbayar MGL
- GOGINASHVILI Irakli GBR
- ALOE V. Mukhamed BRN
- DOUKKALI Hassan MAR
- HRISTOV Mark BUL





Ulaanbaatar Grand Slam 2026

Mongolia, Ulaanbaatar, 19-21 Jun 2026

-81 kg

Men (42)

POOL A

1	ARBUZOV Timur	RUS
2	ALMAZJAN UULU Tegin	KGZ
3	MERDANOV Batyr	TKM
4	BONFERRONI Aurelien	SUI
5	GRUJICIC Vasilije	SRB
6	CASAGLIA Leonardo	ITA
7	FASCHING Bernd	AUT
8	BADRAXH Shinetulga	MGL
9	LEE Joonhwan	KOR
10	SILOT Johan	USA
11	BIBITKO Itay	ISR

1	ARBUZOV T. (RUS)	33	ARBUZOV T. (RUS)
2	ALMAZJAN UULU T. (KGZ)	100 s0 / 000 s1 [02:57]	011 s0 / 000 s1 [04:00]
3	GRUJICIC V. (SRB)	000 s0 / 101 s2 [03:13]	000 s1 / 001 s0 [04:00]
4	CASAGLIA L. (ITA)	000 s1 / 001 s0 [04:00]	
5	FASCHING B. (AUT)		
6	LEE J. (KOR)	000 s0 / 100 s2 [02:27]	
7	SILOT J. (USA)		
8	BIBITKO I. (ISR)	100 s0 / 000 s1 [02:05]	

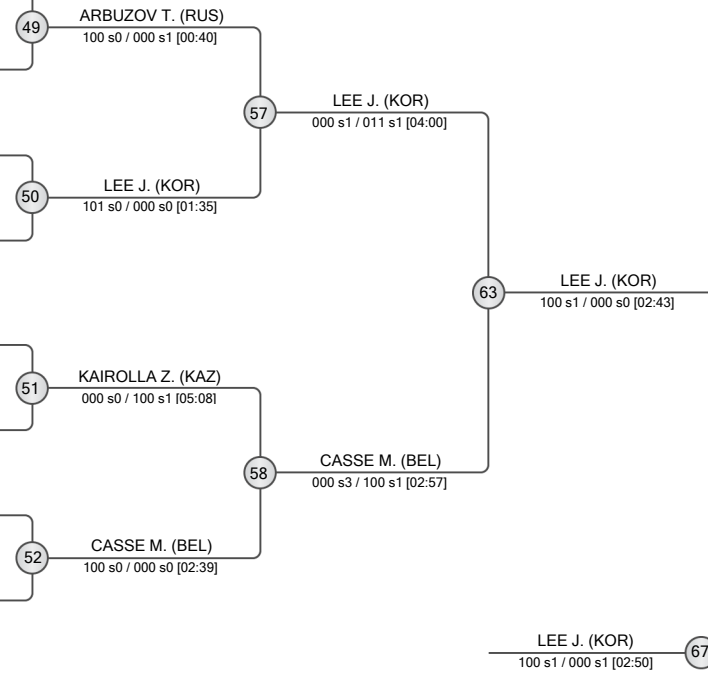

POOL B

9	TCKAEV Zelim	AZE
10	OMAROV Gadzhimurad	UAE
11	TOKAS Harsh	IND
12	KAIROLLA Zhalgas	KAZ
13	TARKOWSKI Fabryczusz	POL
14	CASSE Matthias	BEL
15	GRAMATIKOV Georgi	BUL
16	SULCA Adrian	ROU
17	JUGDERGARAV Enkhtur	MGL
18	ZARAGKAS Aris	GRE

9	TCKAEV Z. (AZE)	37	OMAROV G. (UAE)
10	OMAROV G. (UAE)	000 s2 / 100 s2 [05:54]	000 s0 / 100 s1 [05:08]
11	TOKAS H. (IND)	101 s1 / 000 s3 [03:26]	100 s0 / 000 s0 [01:11]
12	KAIROLLA Z. (KAZ)	100 s0 / 000 s0 [01:11]	
13	TARKOWSKI F. (POL)		
14	CASSE M. (BEL)		
15	GRAMATIKOV G. (BUL)	100 s0 / 000 s3 [04:20]	
16	SULCA A. (ROU)	010 s1 / 000 s2 [04:30]	
17	JUGDERGARAV E. (MGL)	010 s1 / 000 s2 [04:30]	
18	ZARAGKAS A. (GRE)	100 s1 / 000 s3 [02:46]	

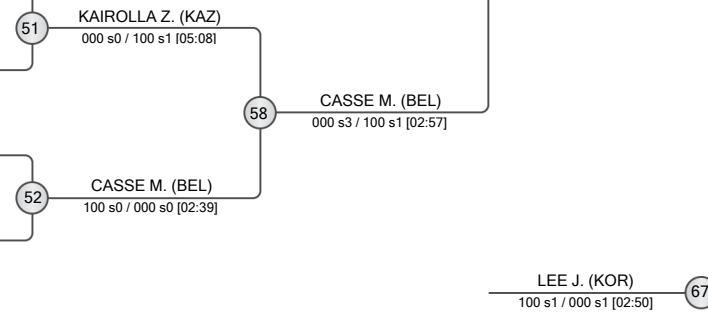

POOL C

17	OINO Yuhei	JPN
18	GERBEKOV Askerbii	BRN
19	DVALASHVILI Zaur	GEO
20	TATALASHVILI Nugzari	UAE
21	GANDIA Adrian	PUR
22	SIMIN Mihajlo	SRB
23	GANZORIG Tuvdenrenchin	MGL
24	BIN ABDUL MAJEED Amir Daniel	MAS
25	SAGYNALIEV Chyngyzkhan	KGZ
26	NARKULOV Askar	KAZ

17	OINO Y. (JPN)	41	OINO Y. (JPN)
18	DVALASHVILI Z. (GEO)	010 s1 / 000 s0 [04:00]	001 s2 / 100 s1 [03:32]
19	TATALASHVILI N. (UAE)	001 s2 / 100 s1 [03:32]	010 s0 / 000 s1 [04:00]
20	GANDIA A. (PUR)	010 s0 / 000 s1 [04:00]	
21	SIMIN M. (SRB)	001 s1 / 100 s0 [03:18]	
22	GANZORIG T. (MGL)	110 s0 / 000 s0 [01:05]	
23	BIN ABDUL MAJEED A. (MAS)	110 s0 / 000 s0 [01:05]	
24	SAGYNALIEV C. (KGZ)	100 s0 / 000 s0 [00:00]	
25	NARKULOV A. (KAZ)	100 s1 / 010 s0 [02:25]	

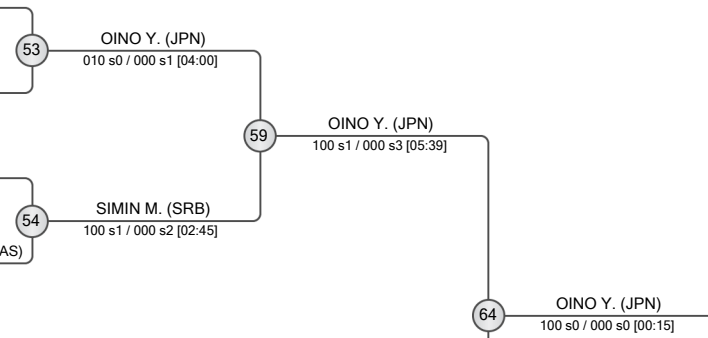

POOL D

25	GAUTHIER DRAPEAU Francois	CAN
26	OYUNCHIMEG Shinebayar	MGL
27	AREGBA Arnaud	FRA
28	CHARNIAK Maksim	BLR
29	SIM Jaeyun	KOR
30	IHANAMAKI Eetu	FIN
31	VALKOV Hristo	BUL
32	TSOUTLASVILI Michail	GRE
33	AYHANOV Agajan	TKM
34	SVIDRAK Mykhailo	UKR
35	ESPOSITO Antonio	ITA

25	GAUTHIER DRAPEAU F. (CAN)	45	GAUTHIER DRAPEAU F. (CAN)
26	OYUNCHIMEG S. (MGL)	010 s2 / 000 s1 [05:47]	010 s2 / 000 s2 [04:28]
27	AREGBA A. (FRA)	100 s2 / 000 s2 [04:28]	001 s0 / 000 s1 [04:00]
28	CHARNIAK M. (BLR)	001 s0 / 000 s1 [04:00]	
29	SIM J. (KOR)	000 s1 / 101 s0 [03:25]	
30	IHANAMAKI E. (FIN)		
31	VALKOV H. (BUL)	100 s1 / 000 s1 [05:05]	
32	TSOUTLASVILI M. (GRE)	100 s0 / 000 s0 [03:55]	
33	AYHANOV A. (TKM)	100 s1 / 000 s1 [05:05]	
34	SVIDRAK M. (UKR)	010 s0 / 002 s0 [04:00]	
35	ESPOSITO A. (ITA)	000 s0 / 001 s0 [04:00]	

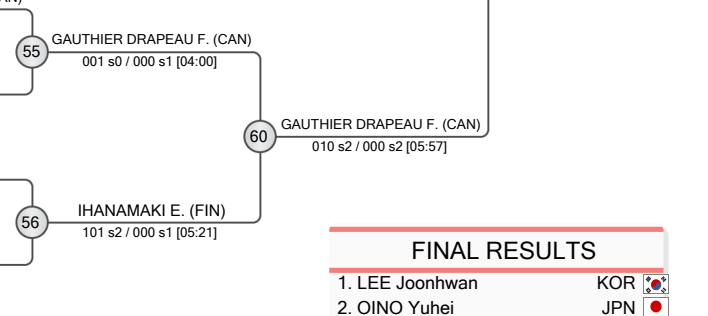

REPECHAGE

61	ARBUZOV T. (RUS)	101 s0 / 000 s0 [01:00]
62	SIMIN M. (SRB)	010 s1 / 000 s0 [04:00]
65	ARBUZOV T. (RUS)	002 s0 / 000 s2 [04:00]
66	SIMIN M. (SRB)	001 s1 / 000 s1 [06:07]

61	ARBUZOV T. (RUS)	101 s0 / 000 s0 [01:00]
62	SIMIN M. (SRB)	010 s1 / 000 s0 [04:00]
65	ARBUZOV T. (RUS)	002 s0 / 000 s2 [04:00]
66	SIMIN M. (SRB)	001 s1 / 000 s1 [06:07]

FINAL RESULTS	
1.	LEE Joonhwan KOR
2.	OINO Yuhei JPN
3.	ARBUZOV Timur RUS
3.	SIMIN Mihajlo SRB
5.	GAUTHIER DRAPEAU Francois CAN
5.	CASSE Matthias BEL
7.	KAIROLLA Zhalgas KAZ
7.	IHANAMAKI Eetu FIN





Ulaanbaatar Grand Slam 2026

Mongolia, Ulaanbaatar, 19-21 Jun 2026

-90 kg

Men (40)

POOL A

1	MURAO Sanshiro (JPN)	33	MURAO S. (JPN)
2	BEDEL Kenny Komi (ITA)	34	SCHARFETTER T. (AUT)
3	SCHARFETTER Thomas (AUT)	35	RUTOVIC B. (SRB)
4	ANKHBAYAR Odjavkhan (MGL)	36	MATHIEU A. (FRA)
5	KANATBEKOV Erzhan (KGZ)	37	CHEN P. (TPE)
6	RUTOVIC Boris (SRB)	38	BARTO A. (SVK)
7	LORSANOV Mansur (RUS)	39	KOPECKY A. (CZE)
8	FRIDMAN ZILBERSTEIN Reem (ISR)	40	KALJULAI K. (EST)
	MATHIEU Alexis (FRA)		
	CHEN Peng-Yu (TPE)		

POOL B

9	TSELIDIS Theodoros (GRE)	41	KIM J. (KOR)
10	CRET Alex (ROU)	42	DE WIT F. (NED)
11	BISSENOV Nurzhan (KAZ)	43	DAVAADORJ U. (MGL)
12	BARTO Alex (SVK)	44	MAJDOV N. (SRB)
13	KIM Jaemin (KOR)	45	JAVAKHISHVILI L. (GEO)
14	KOPECKY Adam (CZE)	46	PARLATI C. (ITA)
15	KOTSOEV Aslan (AZE)	47	NYSSANALI A. (KAZ)
16	BOLDBAATAR Bayanduuren (MGL)	48	ANDONI E. (RUS)
	VAN DIJK Markus (NED)		
	KALJULAI Klien Kristofer (EST)		

POOL C

17	KIM Jonghoon (KOR)	49	MURAO S. (JPN)
18	VARAPAYEU Yahor (BLR)	50	RUTOVIC B. (SRB)
19	GLEESON Bearach (IRL)	51	TSELIDIS T. (GRE)
20	DE WIT Frank (NED)	52	KOPECKY A. (CZE)
21	DAVAADORJ Uuganbileg (MGL)	53	KIM J. (KOR)
22	MAJDOV Nemanja (SRB)	54	MAJDOV N. (SRB)
23	JAVAKHISHVILI Luka (GEO)	55	FATIYEV M. (AZE)
24	JAVAKHISHVILI L. (GEO)	56	NGAYAP HAMBOU M. (FRA)
25	PARLATI Christian (ITA)	57	MURAO S. (JPN)
26	NYSSANALI Aibol (KAZ)	58	KOPECKY A. (CZE)

POOL D

25	FATIYEV Murad (AZE)	59	KIM J. (KOR)
26	SAGAIPOV Israpil (BRN)	60	NGAYAP HAMBOU M. (FRA)
27	HALMUMINOV Omuruzak (TKM)	61	RUTOVIC B. (SRB)
28	JAYNE John (USA)	62	FATIYEV M. (AZE)
29	MARCZAK Derek (POL)	63	MURAO S. (JPN)
30	NGAYAP HAMBOU Maxime-Gael (FRA)	64	KIM J. (KOR)
31	SIVAN Roy (ISR)	65	RUTOVIC B. (SRB)
32	KHASBAATAR Bulgankhuu (MGL)	66	FATIYEV M. (AZE)
	BU Hebilige (CHN)		
	ANDONI Egor (RUS)		

REPECHAGE

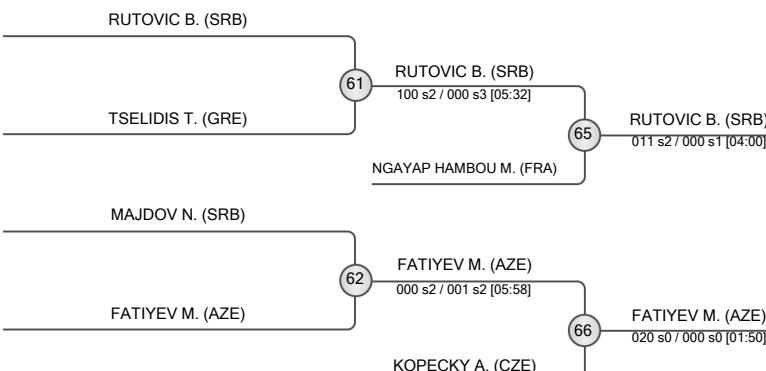

FINAL RESULTS		
1.	MURAO Sanshiro	JPN
2.	KIM Jonghoon	KOR
3.	RUTOVIC Boris	SRB
3.	FATIYEV Murad	AZE
5.	NGAYAP HAMBOU Maxime-Gael	FRA
7.	KOPECKY Adam	CZE
7.	TSELIDIS Theodoros	GRE
7.	MAJDOV Nemanja	SRB





Ulaanbaatar Grand Slam 2026

Mongolia, Ulaanbaatar, 19-21 Jun 2026

-100 kg

Men (37)

POOL A

1	SAVYTSKIY Anton (UKR)	1	SAVYTSKIY A. (UKR)
2	SIMIN Iosif (ISR)	2	SIMIN I. (ISR) 33
3	BAIKAMUROV Marat (KAZ)	3	BAIKAMUROV M. (KAZ) 100 s0 / 000 s0 [00:38]
4	OTGONSUREN Lkhagva-Ochir (MGL)	4	BAIKAMUROV M. (KAZ) 34
5	ARSENIE Rares (ROU)	5	ARSENIE R. (ROU) 010 s1 / 000 s1 [04:00]
6	VEG Zsombor (HUN)	6	VEG Z. (HUN)
7	JEDRZEJEWSKI Michal (POL)	7	HAN J. (KOR) 35
8	HAN Juyeop (KOR)	8	HAN J. (KOR) 000 s3 / 100 s2 [05:12]
9	VARES Jakob (EST)	9	VARES J. (EST) 000 s0 / 110 s0 [03:48]
10	PIRELLI Gennaro (ITA)	10	VARES J. (EST) 50
11		11	PIRELLI G. (ITA) 36
12		12	PIRELLI G. (ITA) 000 s3 / 100 s0 [04:33]

POOL B

9	SULAMANIDZE Ilia (GEO)	9	SULAMANIDZE I. (GEO)
10	SHERAZADISHVILI Nikoloz (ESP)	10	SHERAZADISHVILI N. (ESP) 37
11	MAJANOV Baymyrat (TKM)	11	SULAMANIDZE I. (GEO) 51
12	BAATHE Karl (SWE)	12	MAJANOV B. (TKM) 010 s1 / 000 s1 [04:00]
13	ADAMIAN Arman (RUS)	13	MAJANOV B. (TKM) 38
14	TSERENBAT Gan-Erdene (MGL)	14	MAJANOV B. (TKM) 010 s0 / 000 s0 [04:00]
15	EICH Daniel (SUI)	15	ADAMIAN A. (RUS) 39
16	HUANG Fuchun (CHN)	16	ADAMIAN A. (RUS) 021 s0 / 000 s1 [02:21]
17	ZDRALE Lazar (SRB)	17	EICH D. (SUI) 40
18		18	EICH D. (SUI) 010 s1 / 000 s2 [04:00]
19		19	ZDRALE L. (SRB) 52
20		20	ADAMIAN A. (RUS) 101 s0 / 000 s0 [03:34]

POOL C

17	KOTSOIEV Zelym (AZE)	17	KOTSOIEV Z. (AZE)
18	HAN Seungju (KOR)	18	HAN S. (KOR) 41
19	MATASEJE Benjamin (SVK)	19	KOTSOIEV Z. (AZE) 53
20	SIBISAN Alexandru (ROU)	20	MATASEJE B. (SVK) 42
21	BIFOV Idar (RUS)	21	MATASEJE B. (SVK) 001 s1 / 000 s1 [04:00]
22	KUCZERA Piotr (POL)	22	BIFOV I. (RUS) 43
23	GEORGIEV Boris (BUL)	23	BIFOV I. (RUS) 100 s0 / 000 s0 [00:57]
24	BATDORJ Altangerel (MGL)	24	BATDORJ A. (MGL) 44
25	KROUSSANIOTAKIS Georgios (CYP)	25	KROUSSANIOTAKIS G. (CYP) 44
26		26	KROUSSANIOTAKIS G. (CYP) 000 s0 / 020 s0 [00:27]

POOL D

25	CATHARINA Simeon (NED)	25	CATHARINA S. (NED)
26	MASUCHI Ryotaro (JPN)	26	MASUCHI R. (JPN) 45
27	KARATAYEV Deniz (TKM)	27	MASUCHI R. (JPN) 100 s0 / 000 s3 [01:59]
28	MEKHOUKH Fares (FRA)	28	MEKHOUKH F. (FRA) 46
29	CARLETTI Jean (ITA)	29	MEKHOUKH F. (FRA) 100 s1 / 000 s2 [06:24]
30	KOSTOEV Dzhafar (UAE)	30	KOSTOEV D. (UAE) 47
31	KUMRIC Zlatko (CRO)	31	KOSTOEV D. (UAE) 010 s1 / 000 s2 [04:51]
32	BAYARTSENGEL Khuderchuluun (MGL)	32	BAYARTSENGEL K. (MGL) 48
33	BRASNJOVIC Darko (SRB)	33	BRASNJOVIC D. (SRB) 48
34		34	BRASNJOVIC D. (SRB) 010 s2 / 000 s1 [04:15]

REPECHAGE

61	SULAMANIDZE I. (GEO)	61	SULAMANIDZE I. (GEO) 000 s2 / 001 s2 [04:00]
62	KOTSOIEV Z. (AZE)	62	KOTSOIEV Z. (AZE) 100 s0 / 000 s0 [00:17]
63	PIRELLI G. (ITA)	63	PIRELLI G. (ITA) 001 s0 / 000 s1 [04:53]
64	BIFOV I. (RUS)	64	BIFOV I. (RUS) 100 s0 / 000 s2 [02:40]
65	SULAMANIDZE I. (GEO)	65	SULAMANIDZE I. (GEO) 100 s0 / 000 s0 [00:00]
66	KOTSOIEV Z. (AZE)	66	KOTSOIEV Z. (AZE) 100 s0 / 000 s0 [00:00]
67	PIRELLI G. (ITA)	67	PIRELLI G. (ITA) 100 s2 / 000 s3 [07:24]

FINAL RESULTS		
1.	PIRELLI Gennaro	ITA
2.	BIFOV Idar	RUS
3.	SULAMANIDZE Ilia	GEO
3.	KOTSOIEV Zelym	AZE
5.	KOSTOEV Dzhafar	UAE
7.	ADAMIAN Arman	RUS
7.	BAIKAMUROV Marat	KAZ
7.	MASUCHI Ryotaro	JPN





Ulaanbaatar Grand Slam 2026

Mongolia, Ulaanbaatar, 19-21 Jun 2026

+100 kg

Men (29)

POOL A

	TASOEV Inal	RUS
	AKIANA MONGO Matheo	FRA
	ANTONIOU Giannis	CYP
	ENDOVIITSKII Valerii	RUS
	HEGYI Stephan	AUT
	GANTULGA Khangarid	MGL
	MESSE A BESSONG John	CAN

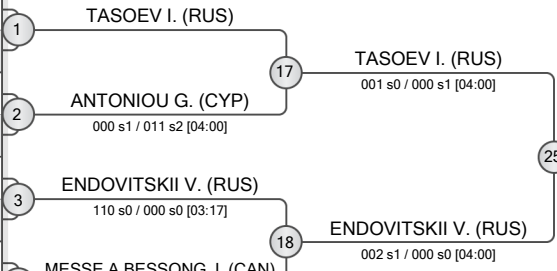

POOL B

	NASIBOV Kanan	AZE
	SORDYL Jakub	POL
	MAGOMEDOMAROV Magomedomar	UAE
	ERTUG Munir	TUR
	GAMZATKHANOV Dzhamal	AZE
	LI Haiyang	CHN
	USUKHBAYAR Perenleijamts	MGL
	KIM Minjong	KOR

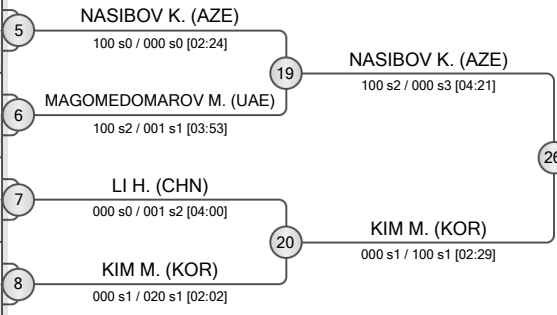

POOL C

	DEMETRASHVILI Irakli	GEO
	DOBRE Darius	ROU
	GANTULGA Altanbagana	MGL
	NAKANO Kanta	JPN
	SVIRYD Mikita	CRO
	FIZEL Marius	SVK
	LAHBOUB Mohammed	MAR

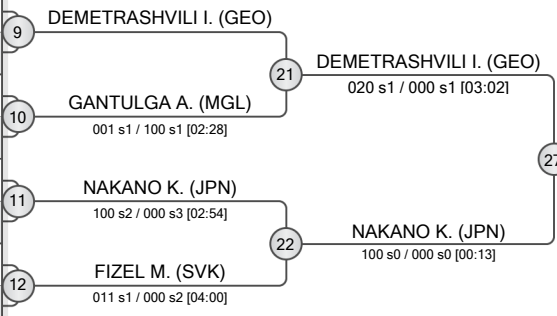

POOL D

	SPIJKERS Jur	NED
	PUUMALAINEN Martti	FIN
	ULZIIBAYAR Duurenbayar	MGL
	KRPALEK Lukas	CZE
	LEE Seungyeob	KOR
	DAI You-Ming	TPE
	OZCICEK-TAKAGI Kayhan	AUS

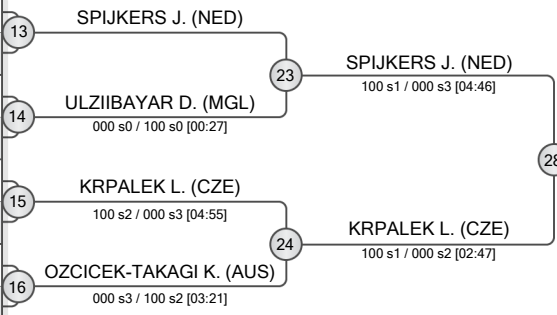

REPECHAGE

ENDOVIITSKII V. (RUS)	29	NASIBOV K. (AZE)	
NASIBOV K. (AZE)		30	KRPALEK L. (CZE)
NAKANO K. (JPN)		31	TASOEV I. (RUS)
KRPALEK L. (CZE)		32	SPIJKERS J. (NED)
TASOEV I. (RUS)		33	ENDOVIITSKII V. (RUS)
SPIJKERS J. (NED)		34	NAKANO K. (JPN)

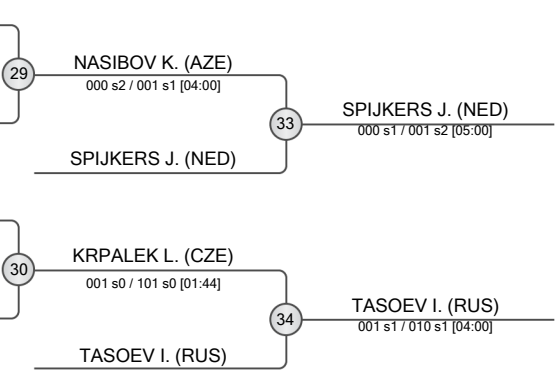

FINAL RESULTS	
1. KIM Minjong	KOR
2. DEMETRASHVILI Irakli	GEO
3. SPIJKERS Jur	NED
3. TASOEV Inal	RUS
5. NASIBOV Kanan	AZE
5. KRPALEK Lukas	CZE
7. ENDOVIITSKII Valerii	RUS
7. NAKANO Kanta	JPN





Ulaanbaatar Grand Slam 2026

Mongolia, Ulaanbaatar, 19-21 Jun 2026

-48 kg

Women (29)

POOL A

	BOUKLI Shirine	FRA
	TYNBAYEVA Galiya	KAZ
	MALCA Tamar	ISR
	GERSJES Amber	NED
	BAVUUDORJ Baasankhuu	MGL
	HA NGOC Chi	VIE
	PETIT Lois	BEL

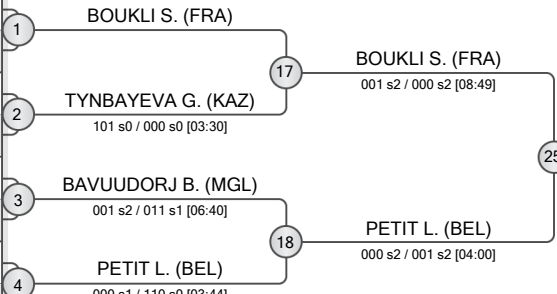

POOL B

	GILIAZOVA Sabina	RUS
	ERSIN Sila	TUR
	YU Juhee	KOR
	LKHAGVAJAV Bulgan	MGL
	VARGAS LEY Mary Dee	CHI
	ZHUANG Wenna	CHN
	MILANI Francesca	ITA
	RODONAIA Julieta	GEO

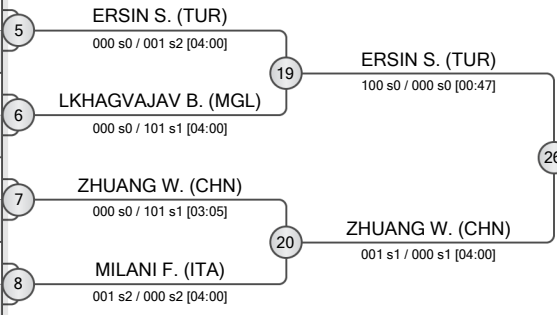

POOL C

	JAMSRAN Anudari	MGL
	AVANZATO Asia	ITA
	BEDER Tugce	TUR
	GANBAATAR Narantsetseg	MGL
	COSTA Catarina	POR
	GELDIYEVA Ejegyz	TKM
	BURKEYEVA Diana	KAZ

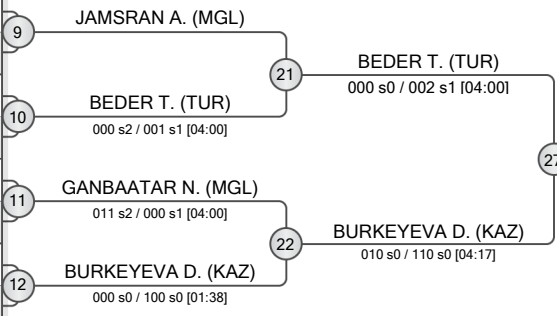

POOL D

	MARTINEZ ABELENDA Laura	ESP
	JUNG Su Jin	KOR
	TO Trang	VIE
	KOGA Wakana	JPN
	HAMIDOVA Shafag	AZE
	VOROBEVA Marina	RUS
	LIN Chen-Hao	TPE

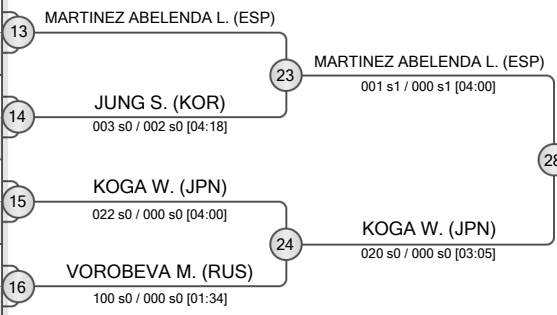

REPECHAGE

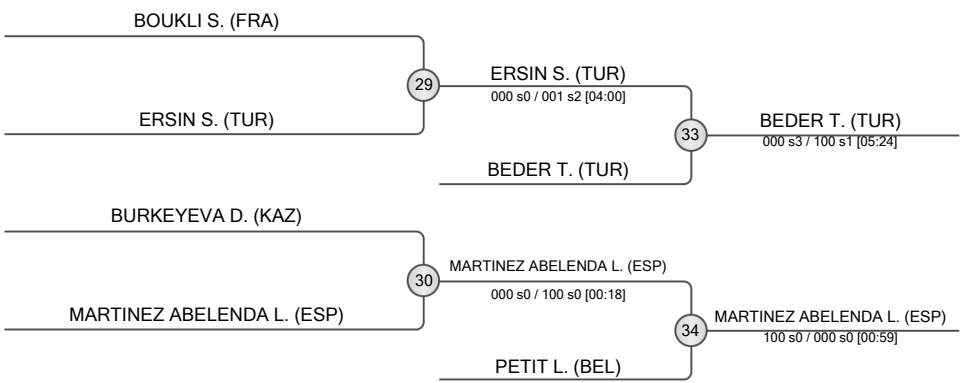

FINAL RESULTS	
1. KOGA Wakana	JPN
2. ZHUANG Wenna	CHN
3. BEDER Tugce	TUR
3. MARTINEZ ABELENDA Laura	ESP
5. ERSIN Sila	TUR
5. PETIT Lois	BEL
7. BOUKLI Shirine	FRA
7. BURKEYEVA Diana	KAZ





Ulaanbaatar Grand Slam 2026

Mongolia, Ulaanbaatar, 19-21 Jun 2026

-52 kg

Women (29)

POOL A

	BALLHAUS Mascha	GER
	SHEN Yi-Hsi	TPE
	NUGAEVA Liliia	RUS
	ABE Uta	JPN
	BEATON Evelyn	CAN
	OYUNGEREL Oyunchimeg	MGL
	EASTON Tinka	AUS

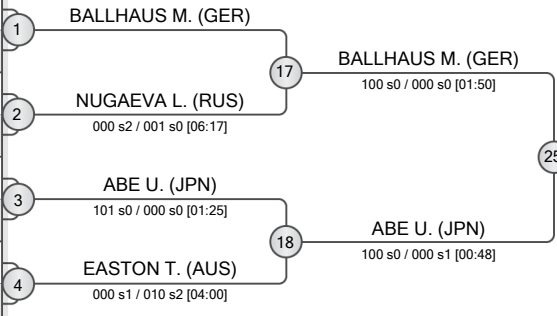

POOL B

	PUPP Reka	HUN
	MAMMADALIYEVA Gultaj	AZE
	ASVESTA Sofia	CYP
	NGUYEN THI Tuyet Han	VIE
	BISHRELT Khorloodoi	UAE
	KIM Minjeong	KOR
	IRAUI Soumiya	MAR
	BAYANMUNKH Urantzaya	MGL

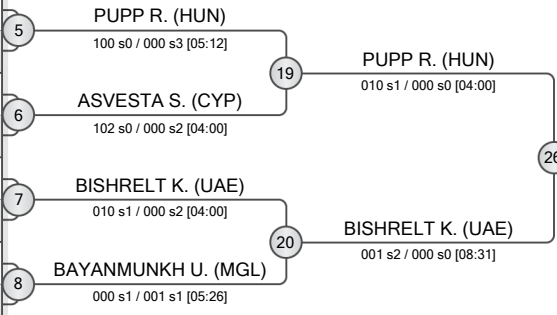

POOL C

	GIUFFRIDA Odette	ITA
	DIMITROVA Gabriela	BUL
	PONT Blandine	FRA
	TORO SOLER Ariane	ESP
	KALETA Aleksandra	POL
	YEREZHEPOVA Aruzhan	KAZ
	TSERENOGTOKH Gal-Od	MGL

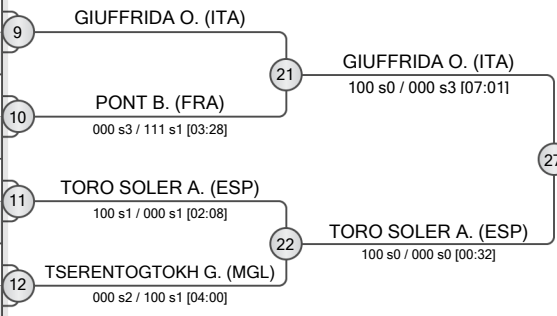

POOL D

	GYERTYAS Roza	HUN
	OMIROVA Narjema	TKM
	PRIMO Gefen	ISR
	MYAGMARSUREN Nandin-Erdene	MGL
	JANG Seyun	KOR
	LAM THI NGAN Ha	VIE
	VAN KREVEL Naomi	NED

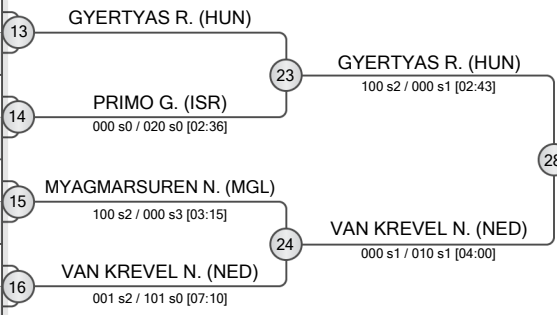

REPECHAGE

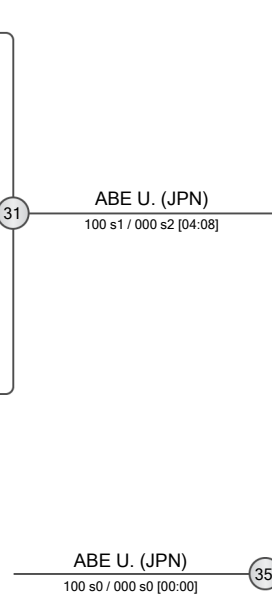
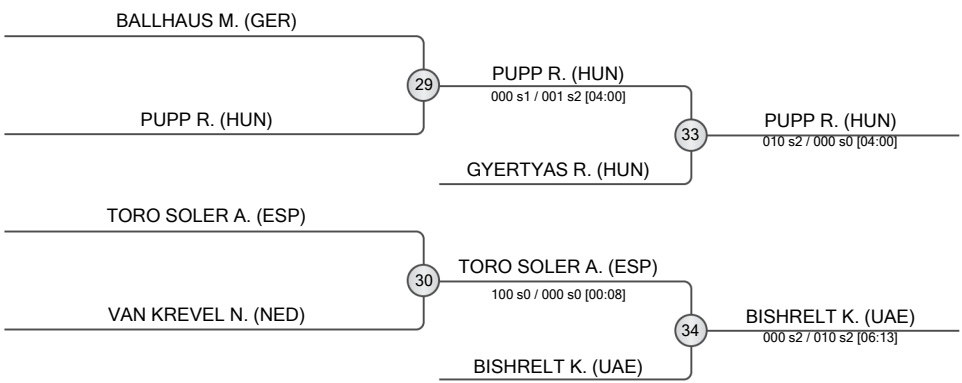

FINAL RESULTS	
1. ABE Uta	
2. GIUFFRIDA Odette	
3. PUPP Reka	
3. BISHRELT Khorloodoi	
5. GYERTYAS Roza	
5. TORO SOLER Ariane	
7. BALLHAUS Mascha	
7. VAN KREVEL Naomi	





Ulaanbaatar Grand Slam 2026

Mongolia, Ulaanbaatar, 19-21 Jun 2026

-57 kg

Women (29)

POOL A

	NELSON LEVY Timna	ISR
	TONIOLO Veronica	ITA
	ELKINA Natalia	RUS
	HUH Mimi	KOR
	MASHBAT Tsendbazar	MGL
	ABDIROVA Dana	KAZ
	PARDAYEVA Maysa	TKM

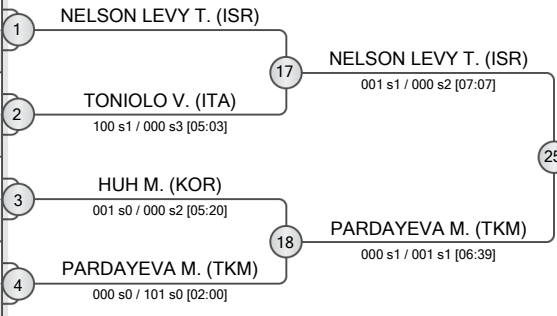

POOL B

	OMORI Akari	JPN
	LKHAGVASUREN Sosorbaram	MGL
	BUDAK Aysenur	TUR
	TAO Yuying	CHN
	TOPRAK Acelya	GBR
	VAN DE MEEBERG Shannon	NED
	LEOPOLD Maya	URU
	MATIKAINEN Pihla	FIN

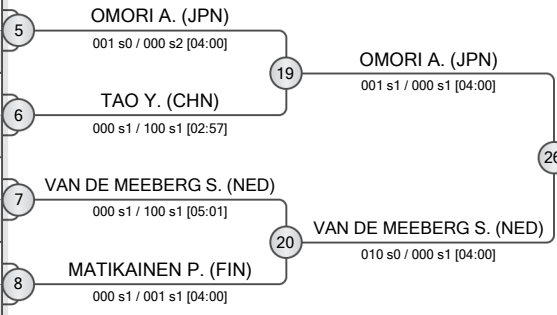

POOL C

	MOKDAR Faiza	FRA
	SHEMESH Inbal	ISR
	ORAZNYAZOVA Medine	TKM
	BALLHAUS Seija	GER
	ENKHBAATAR Nomintuya	MGL
	ZUEVA Irina	RUS
	MUKHANBET Dina	KAZ

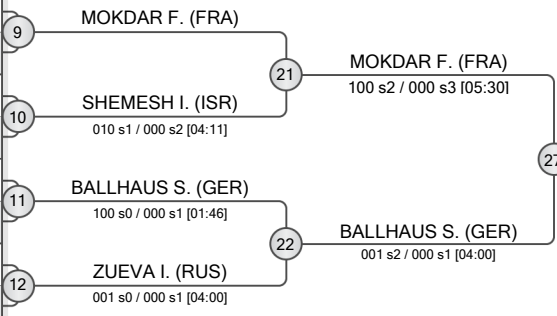

POOL D

	CYSIQUE Sarah Leonie	FRA
	LIU Tzu-Yun	TPE
	BOZKURT Hasret	TUR
	TERBISH Ariunzaya	MGL
	SHIN Yuna	KOR
	WANG Nan	CHN
	SALONEN Pihla	FIN

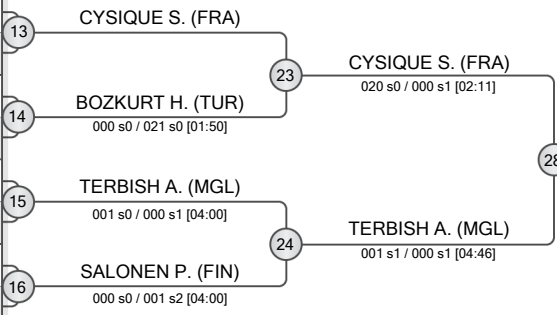

REPECHAGE

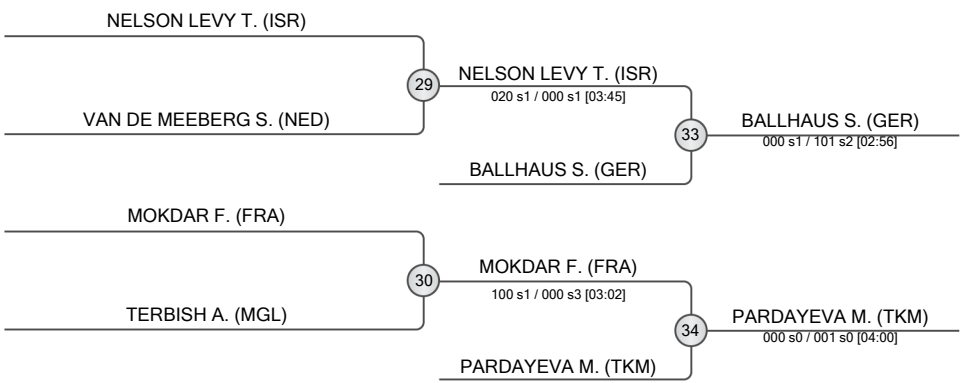

FINAL RESULTS	
1.	OMORI Akari
2.	CYSIQUE Sarah Leonie
3.	BALLHAUS Seija
3.	PARDAYEVA Maysa
5.	NELSON LEVY Timna
5.	MOKDAR Faiza
7.	VAN DE MEEBERG Shannon
7.	TERBISH Ariunzaya





Ulaanbaatar Grand Slam 2026

Mongolia, Ulaanbaatar, 19-21 Jun 2026

-63 kg

Women (28)

POOL A

	LKHAGVATOGOO Enkhriilen	MGL
	KIM Yeji	KOR
	KROPSKA Natalia	POL
	PIOVESANA Lubjana	AUT
	SIMIC Nina	CRO
	STOLZE Friederike	GER
	ASSYLKHANOVA Damelya	KAZ

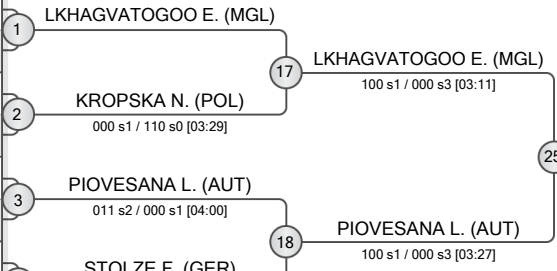

POOL B

	VAN LIESHOUT Joanne	NED
	RUSSO Savita	ITA
	ALIZADA Fidan	AZE
	DEKETER Manon	FRA
	PRIMO Kerem	ISR
	GANKHUYAG Enkhjin	MGL
	GALITSKAIA Kseniia	RUS

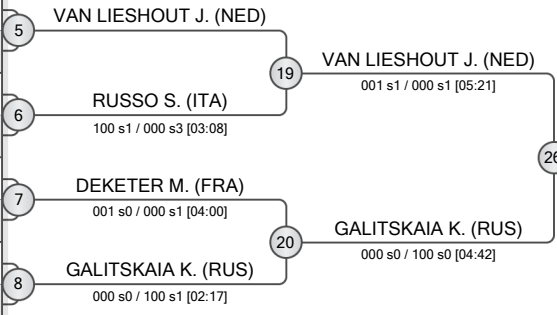

POOL C

	KAJU Haruka	JPN
	KIM Jisu	KOR
	TAIBI Chaimae	MAR
	AVANZATO Carlotta	ITA
	MAKRETSKAYA Yana	BLR
	YUAN Pei Chun	TPE
	KHURELCHULUUN Maralmaa	MGL

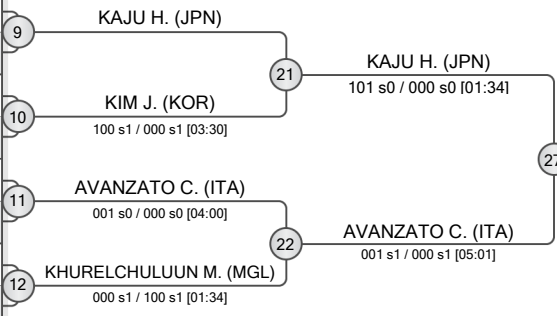

POOL D

	OBERAN Iva	CRO
	YERGALIYEVA Samalay	KAZ
	BAUER Sara-Joy	GER
	BOLD Gankhaich	MGL
	ZACHOVA Renata	CZE
	MANOVA Yoana	BUL
	LILUASHVILI Dali	RUS

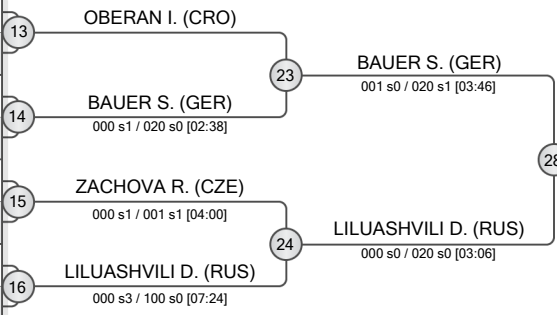

REPECHAGE

LKHAGVATOGOO E. (MGL)	29 LKHAGVATOGOO E. (MGL)
GALITSKAIA K. (RUS)	30 BAUER S. (GER)
AVANZATO C. (ITA)	31 VAN LIESHOUT J. (NED)
BAUER S. (GER)	32 KAJU H. (JPN)
	33 LILUASHVILI D. (RUS)
	34 PIOVESANA L. (AUT)

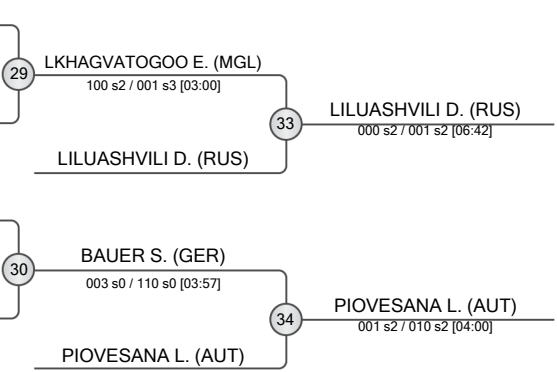

FINAL RESULTS

1. KAJU Haruka	JPN	
2. VAN LIESHOUT Joanne	NED	
3. LILUASHVILI Dali	RUS	
3. PIOVESANA Lubjana	AUT	
5. LKHAGVATOGOO Enkhriilen	MGL	
5. BAUER Sara-Joy	GER	
7. GALITSKAIA Kseniia	RUS	
7. AVANZATO Carlotta	ITA	





Ulaanbaatar Grand Slam 2026

Mongolia, Ulaanbaatar, 19-21 Jun 2026

-70 kg

Women (33)

POOL A

1	COUGHLAN Aoife (AUS)	33	COUGHLAN A. (AUS)
2	JADAMBA Delger (MGL)	34	ORUC S. (TUR)
3	POLLERES Michaela (AUT)	35	STANGHERLIN G. (ITA)
4	ORUC Sinem (TUR)	36	VAN DIJKE S. (NED)
5	STANGHERLIN Giorgia (ITA)		
6	SCHUSTER Kaja (SLO)		
7	KIM Hyemi (KOR)		
8	VAN DIJKE Sanne (NED)		

POOL B

9	BUTKEREIT Miriam (GER)	37	BUTKEREIT M. (GER)
10	MURADOVA Yyldyz (TKM)	38	TAIMAZOVA M. (RUS)
11	TSUNODA ROUSTANT Ai (ESP)	39	GOSHEN M. (ISR)
12	TAIMAZOVA Madina (RUS)	40	GULBANI N. (GEO)
13	ERIKSSON Ida (SWE)		
14	GOSHEN Maya (ISR)		
15	GULBANI Nino (GEO)		
16	SARANTSETSEG Lkhagvadulam (MGL)		

POOL C

17	CVJETKO Lara (CRO)	41	CVJETKO L. (CRO)
18	RUSLANOVA Oguljan (TKM)	42	NOVITSKY A. (ISR)
19	KHADBAATAR Buyanjargal (MGL)	43	PEDROTTI I. (ITA)
20	POHL Dena (GER)	44	DE VOOGD M. (NED)
21	NOVITSKY Adelina (ISR)		
22	PEDROTTI Irene (ITA)		
23	TCHANTURIA Mariam (GEO)		
24	AGHAYEVA Sudaba (AZE)		
25	DE VOOGD Margit (NED)		

POOL D

25	TANAKA Shiho (JPN)	45	TANAKA S. (JPN)
26	FIZELOVA Ema (SVK)	46	LEE Y. (KOR)
27	LEE Yerang (KOR)	47	EME C. (FRA)
28	URAN-ULZII Anujin (MGL)	48	KOREN N. (SLO)
29	EME Clemence (FRA)		
30	NILSSON Ingrid (SWE)		
31	KOREN Nika (SLO)		
32	LIAO Yu-Jung (TPE)		

REPECHAGE

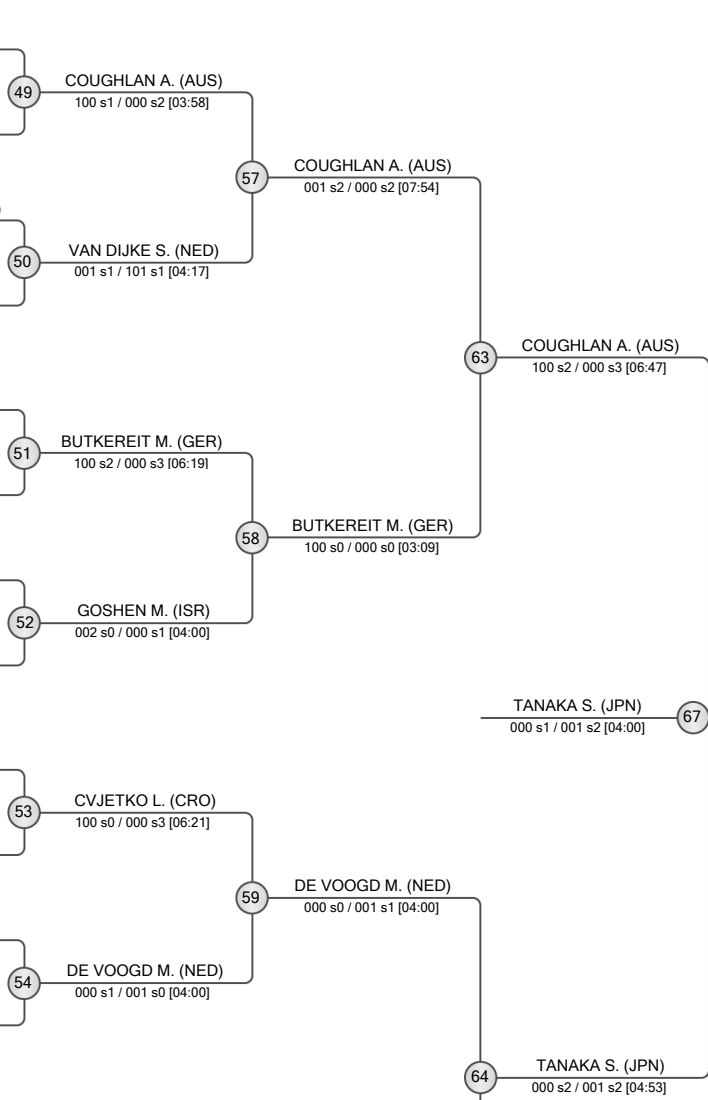
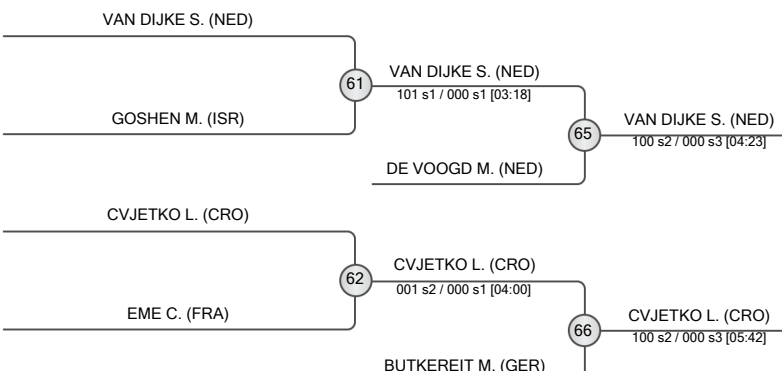

FINAL RESULTS		
1.	TANAKA Shiho	JPN
2.	COUGHLAN Aoife	AUS
3.	VAN DIJKE Sanne	NED
3.	CVJETKO Lara	CRO
5.	DE VOOGD Margit	NED
7.	BUTKEREIT Miriam	GER
7.	GOSHEN Maya	ISR
7.	EME Clemence	FRA





Ulaanbaatar Grand Slam 2026

Mongolia, Ulaanbaatar, 19-21 Jun 2026

-78 kg

Women (28)

POOL A

	OLEK Anna Monta	GER
	RIABCHENKO Alexandra	RUS
	AILTGUIBAATAR Dulamsuren	MGL
	TCHEUMEO Audrey	FRA
	DUDENAITE Migle Julija	LTU
	GULENAY Tuana	TUR
	HSU WANG Shu Huei	TPE

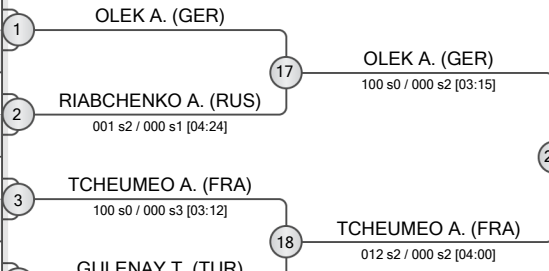

POOL B

	LOBNIK Metka	SLO
	BATSUURI Nyam-Erdene	MGL
	GODBOUT Coralie	CAN
	IKEDA Kurena	JPN
	SWAN Maria	AUS
	VAN HEEMST Yael	NED
	KANTSAVAYA Darya	BLR

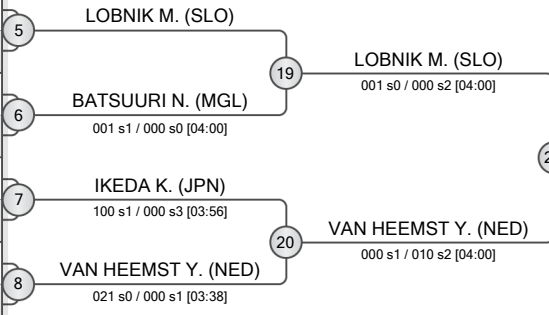

POOL C

	LYTVYENKO Yelyzaveta	UAE
	ZABIC Milica	SRB
	DENGG Elena	AUT
	OLAYA Brenda	COL
	GORGUET-VERANES Maidelines	ROU
	KAMPS Marit	NED
	OTGONBAYAR Khuslen	MGL

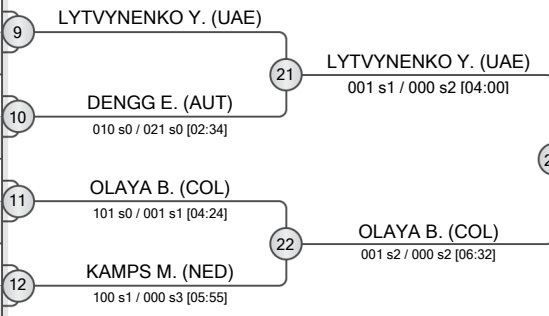

POOL D

	ISSOUFI Kaila	FRA
	MICHAELIDOU Zanet	CYP
	PAVIC Petrunjela	CRO
	BOEHM Alina	GER
	WU Hongtao	CHN
	ERDENEBAT Buyan-Ulzii	MGL
	KRAPU Emma	FIN

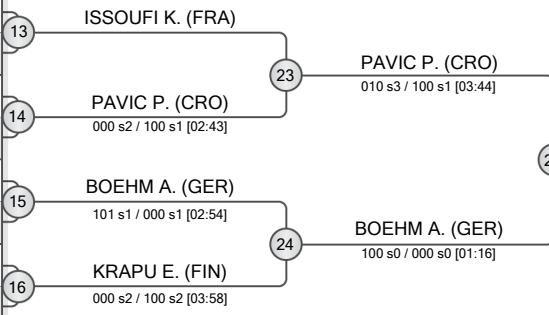

REPECHAGE

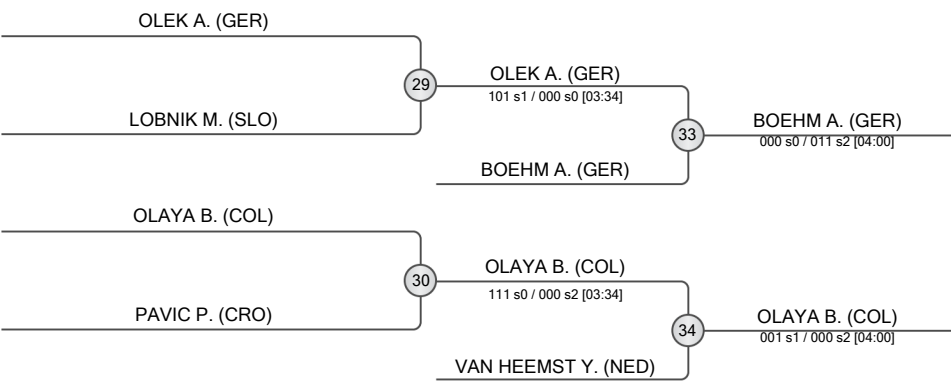

LYTVYENKO Y. (UAE) 000 s1 / 100 s0 [03:26]

LYTVYENKO Y. (UAE) 002 s0 / 001 s1 [04:00]

LYTVYENKO Y. (UAE) 100 s0 / 000 s3 [03:26]

FINAL RESULTS	
1. LYTVYENKO Yelyzaveta	UAE
2. TCHEUMEO Audrey	FRA
3. BOEHM Alina	GER
3. OLAYA Brenda	COL
5. OLEK Anna Monta	GER
5. VAN HEEMST Yael	NED
7. LOBNIK Metka	SLO
7. PAVIC Petrunjela	CRO





Ulaanbaatar Grand Slam 2026

Mongolia, Ulaanbaatar, 19-21 Jun 2026

+ 78 kg

Women (25)

POOL A

	HERSHKO Raz	ISR
	ENKHBAYAR Enkhzul	MGL
	SU Pin-Tzu	TPE
	ARAI Mao	JPN
	WOJTA Lilli Louise	GER
	BOUVIER Gabrielle	BEL
	RADIC Tina	CRO

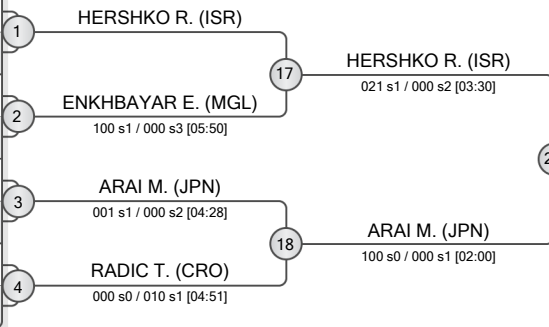

POOL B

	TAVANO Asya	ITA
	BERLIKASH Kamila	KAZ
	STARTSEVA Elis	RUS
	AYIMAN Jinesinuer	CHN
	ENKHMEND Jargalmaa	MGL
	AKTAS Emma-Melis	EST

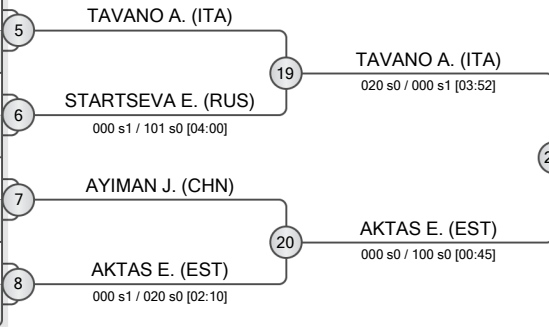

POOL C

	DICKO Romane	FRA
	AMARSAIKHAN Adiyasuren	MGL
	JIA Bingqian	CHN
	CANCAN Celia	FRA
	CHANG Ling Fang	TPE
	SOMKHISHVILI Sophio	GEO

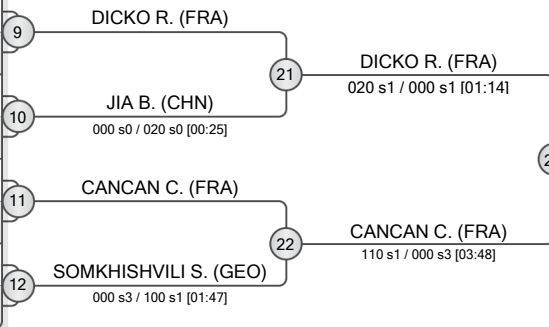

POOL D

	VUKOVIC Helena	CRO
	DAMBADARJAA Nominzul	MGL
	IVANOVA Mariia	RUS
	MISHINER Yuli Alma	ISR
	KAISINOVA Madina	AZE
	RAMAZANOVA Akerke	KAZ

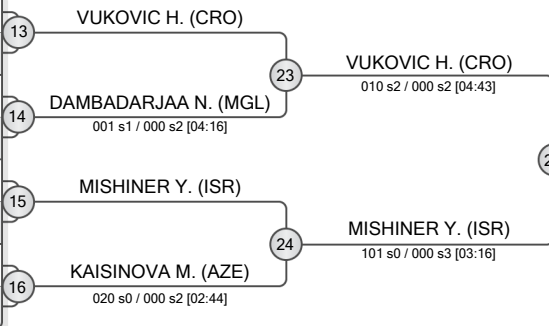

REPECHAGE

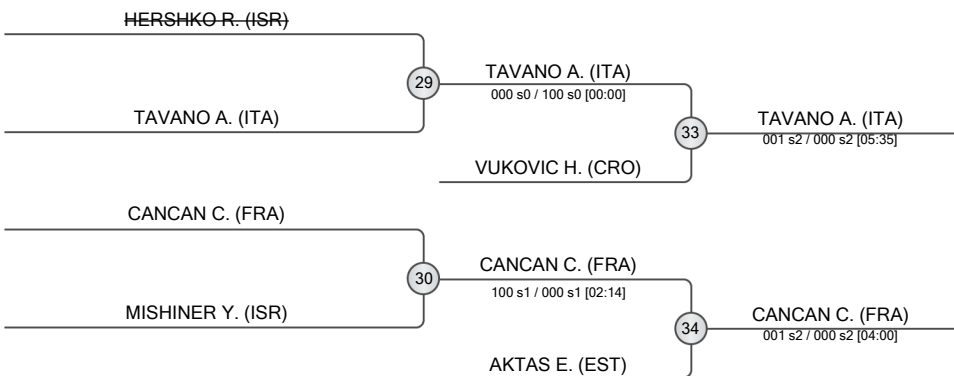

FINAL RESULTS

1.	ARAI Mao	JPN
2.	DICKO Romane	FRA
3.	TAVANO Asya	ITA
3.	CANCAN Celia	FRA
5.	VUKOVIC Helena	CRO
5.	AKTAS Emma-Melis	EST
7.	HERSHKO Raz	ISR
7.	MISHINER Yuli Alma	ISR

