

POOL A

	LEE Casey	AUS
	LAUKHIN Luka	RUS
	NAVEA Zechariah	AUS

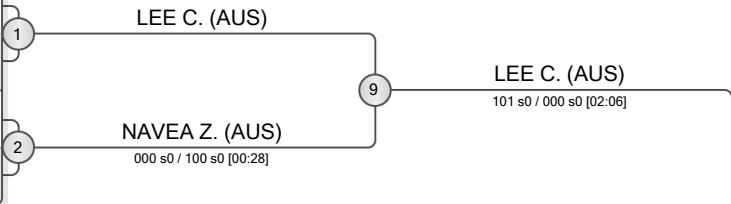

POOL B

	HILL Laurence	GBR
	CRUZALTA APODACA Arath	MEX
	HUCENT Kaan	AUS

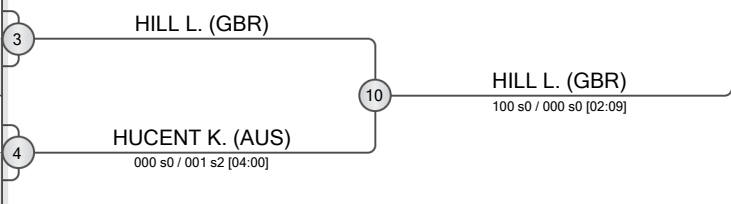

POOL C

	KELLY Kaian	AUS
	TERAN VELAZQUEZ Ricardo Manuel	MEX
	SENGA Jonas	AUS

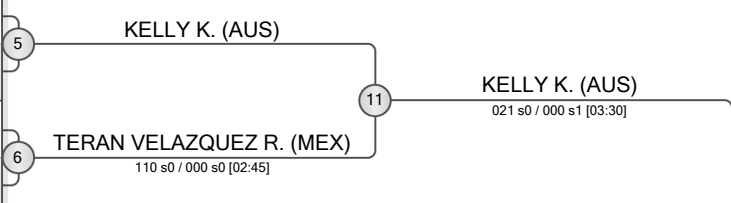

POOL D

	BROSIUS Hayden	NZL
	KHAN Gavreil Shanran Loo E	HKG
	PLATONOV Nicholas	AUS

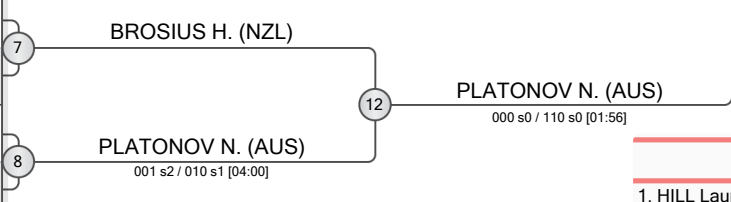

REPECHAGE

NAVEA Z. (AUS)	13	NAVEA Z. (AUS)
HUCENT K. (AUS)	14	HUCENT K. (AUS)
TERAN VELAZQUEZ R. (MEX)	15	TERAN VELAZQUEZ R. (MEX)
KHAN G. (HKG)	16	KHAN G. (HKG)
BROSIUS H. (NZL)	16	BROSIUS H. (NZL)

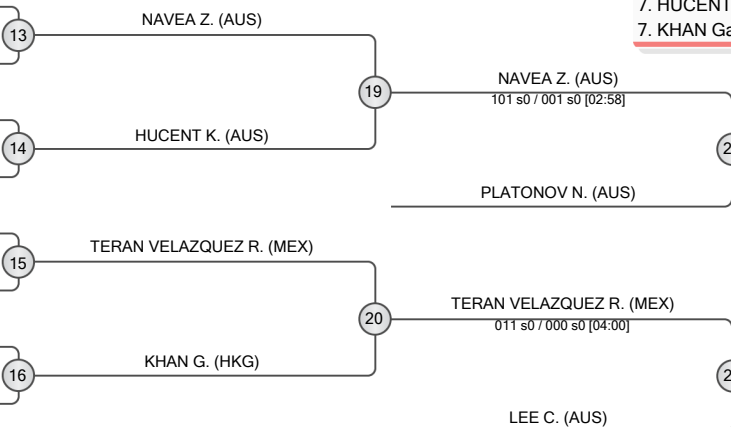

FINAL RESULTS		
1.	HILL Laurence	GBR
2.	KELLY Kaian	AUS
3.	NAVEA Zechariah	AUS
3.	LEE Casey	AUS
5.	PLATONOV Nicholas	AUS
5.	TERAN VELAZQUEZ Ricardo Manuel	MEX
7.	HUCENT Kaan	AUS
7.	KHAN Gavreil Shanran Loo E	HKG

POOL A

	HYNES Conrad	NZL
	HOGARTH Noa	AUS
	HOGARTH Oliver	AUS

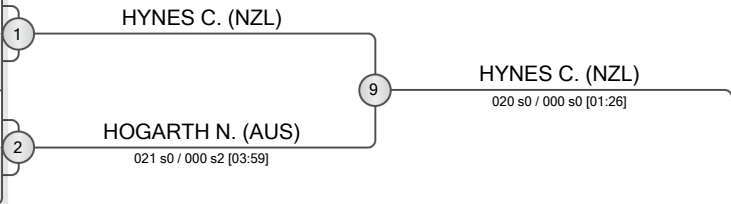

POOL B

	TRINDADE DE ABREU Owen	NCL
	YEUNG Wing Yat	HKG

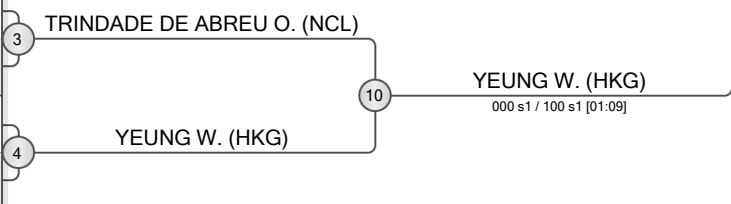

POOL C

	XU Aaron	AUS
	ONG Julius	AUS
	CHINCHILLA Isaac	AUS

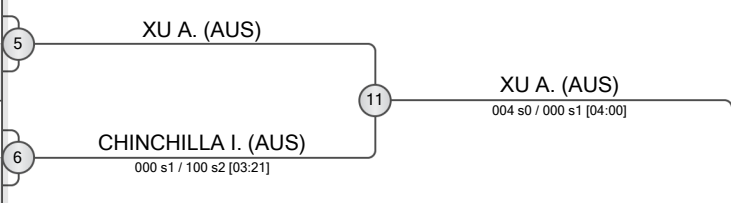

POOL D

	NEWMAN Charlie	AUS
	TRAINOR Thomas	AUS
	PEAKE Crosby	AUS

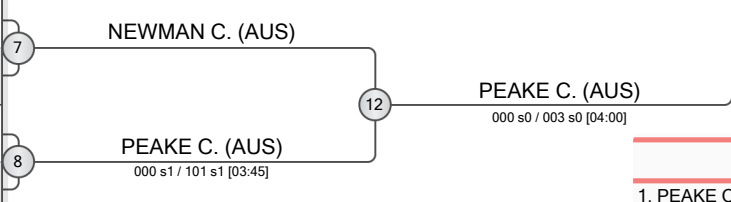

REPECHAGE

HOGARTH N. (AUS)	13	HOGARTH N. (AUS)
TRINDADE DE ABREU O. (NCL)	14	TRINDADE DE ABREU O. (NCL)
CHINCHILLA I. (AUS)	15	CHINCHILLA I. (AUS)
TRAINOR T. (AUS)	16	TRAINOR T. (AUS)
NEWMAN C. (AUS)	16	TRAINOR T. (AUS)

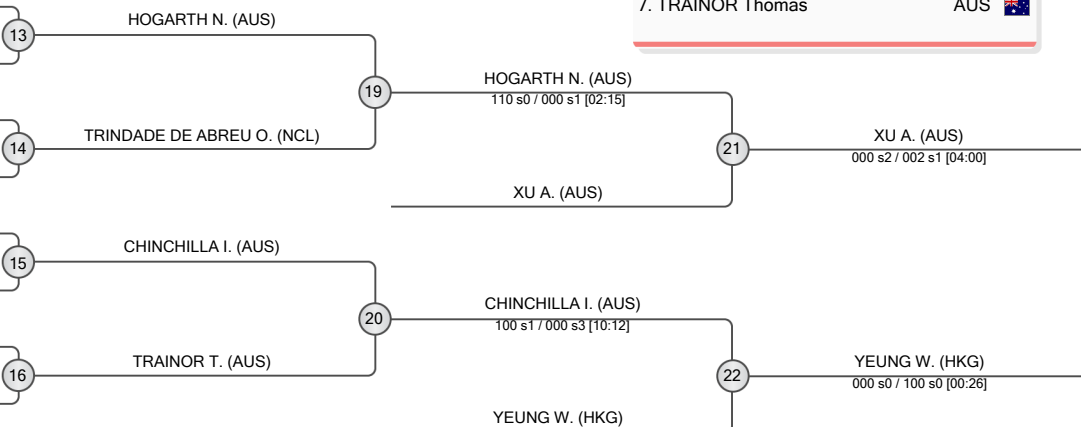

FINAL RESULTS		
1.	PEAKE Crosby	AUS
2.	HYNES Conrad	NZL
3.	XU Aaron	AUS
3.	YEUNG Wing Yat	HKG
5.	HOGARTH Noa	AUS
5.	CHINCHILLA Isaac	AUS
7.	TRAINOR Thomas	AUS

POOL A

	DOBRIC Nikola	AUS
	AIZIKOV Roman	RUS
	ASANO Kento	AUS

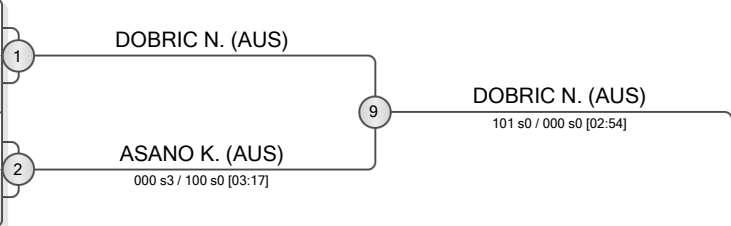

POOL B

	ONG Jacob	AUS
	ALKHALAF Abdulmajeed Sakhr M	KSA

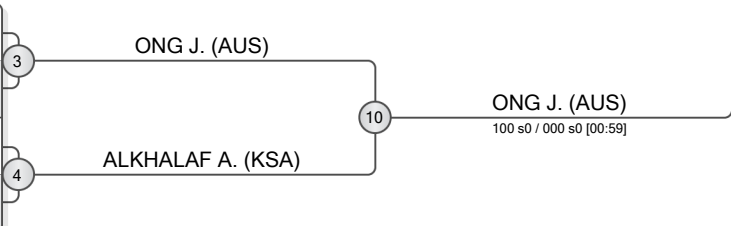

POOL C

	BELL Jake	AUS
	COLLINS Caelan	AUS
	TEO Chee Le	SGP

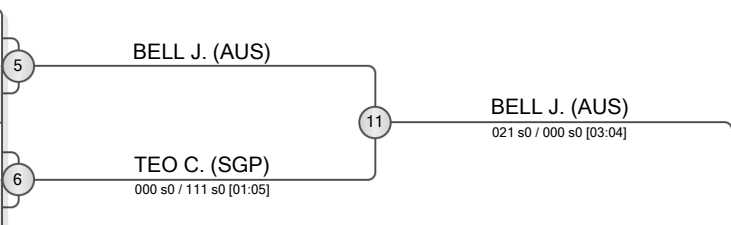

POOL D

	FUERSTE Scott	AUS
	KELLOU Enzo	NCL

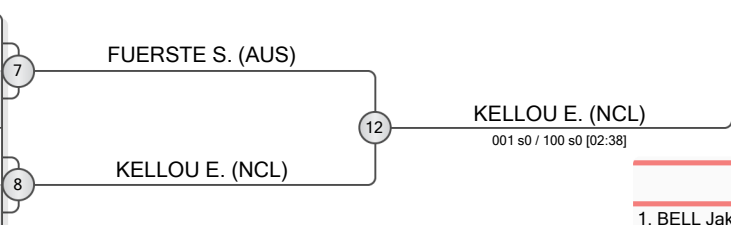

REPECHAGE

ASANO K. (AUS)	13
ALKHALAF A. (KSA)	14
TEO C. (SGP)	15
FUERSTE S. (AUS)	16

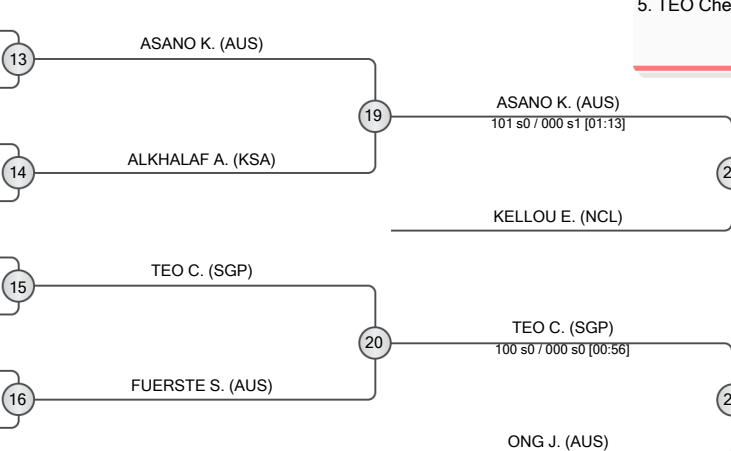

FINAL RESULTS		
1.	BELL Jake	AUS
2.	DOBRIC Nikola	AUS
3.	ASANO Kento	AUS
3.	ONG Jacob	AUS
5.	KELLOU Enzo	NCL
5.	TEO Chee Le	SGP



Mandurah Junior Oceania Cup 2026

Australia, Mandurah, 3 May 2026

-81 kg
Men (2)

Num.	Competitor		1	2	Wins	Points
1.	RAMIREZ Jai	AUS		0	0	0
2.	JOHNSTON Kyle	AUS	100		1	100

RAMIREZ Jai	AUS
JOHNSTON Kyle	AUS

1

JOHNSTON K. (AUS)
000 s0 / 100 s0 [00:28]

FINAL RESULTS	
1. JOHNSTON Kyle	AUS



Mandurah Junior Oceania Cup 2026

Australia, Mandurah, 3 May 2026

-90 kg
Men (2)

Num.	Competitor		1	2	Wins	Points
1.	ALSHAMMARI Khalid	KSA		0	0	0
2.	BROWN Alexander	NZL	100		1	100



ALSHAMMARI Khalid	KSA
BROWN Alexander	NZL

1

BROWN A. (NZL)
000 s0 / 100 s0 [00:45]

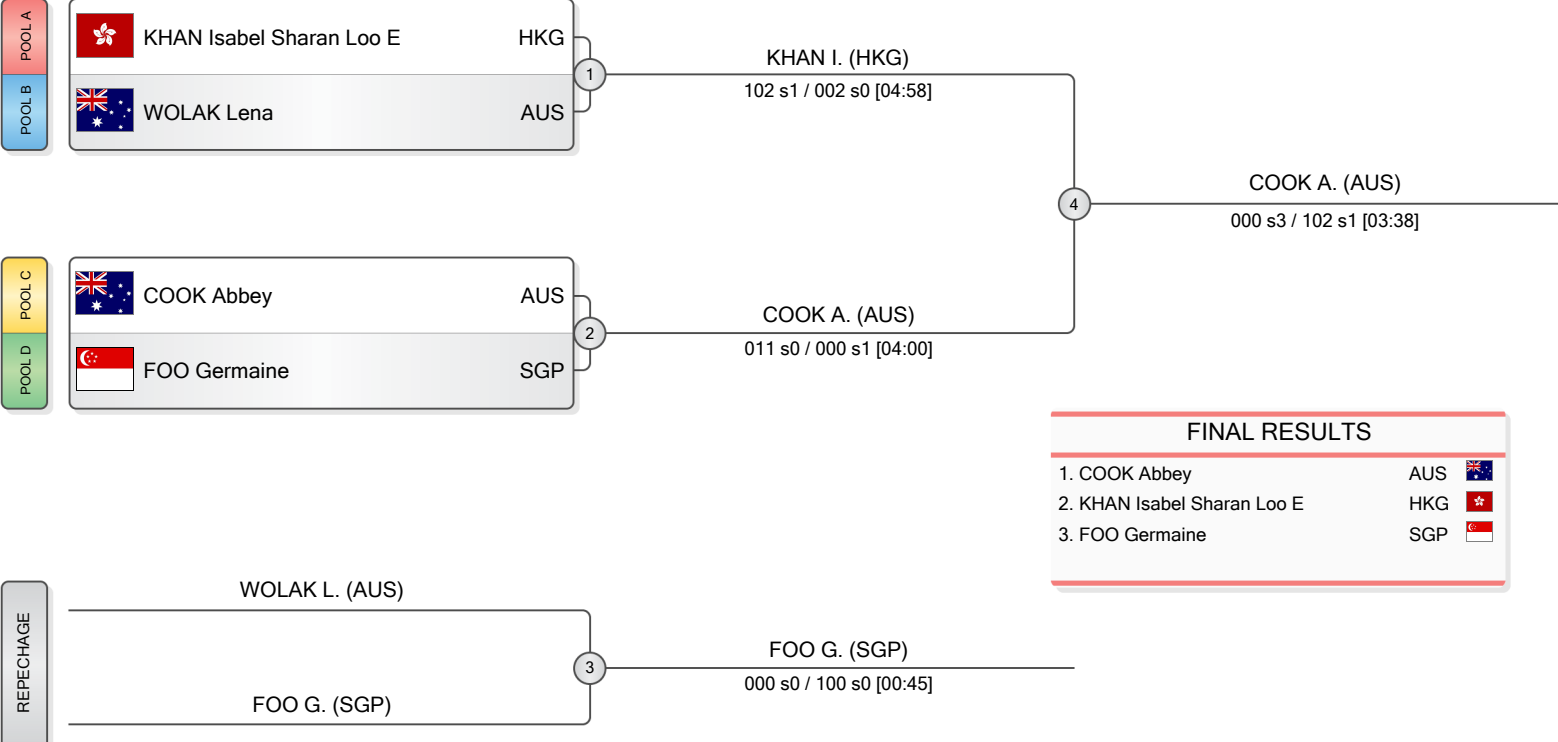
FINAL RESULTS	
1. BROWN Alexander	NZL



FINAL RESULTS		
1.	COOK Abbey	AUS 
2.	KHAN Isabel Sharan Loo E	HKG 
3.	FOO Germaine	SGP 



Mandurah Junior Oceania Cup 2026

Australia, Mandurah, 3 May 2026

-52 kg

Women (3)

Num.	Competitor		1	2	3	Wins	Points
1.	SIBONI Mia	AUS		100	1	2	101
2.	TRAINOR Amelia	AUS	1		0	0	1
3.	LAU Wai Sum	HKG	0	1		1	1

SIBONI Mia	AUS	1	SIBONI M. (AUS)
TRAINOR Amelia	AUS		

101 s0 / 001 s0 [02:29]

FINAL RESULTS	
1. LAU Wai Sum	HKG
2. SIBONI Mia	AUS

SIBONI Mia	AUS	2	SIBONI M. (AUS)
LAU Wai Sum	HKG		

001 s1 / 000 s0 [04:00]

TRAINOR Amelia	AUS	3	LAU W. (HKG)
LAU Wai Sum	HKG		

000 s0 / 001 s2 [04:00]

SIBONI Mia	AUS	4	LAU W. (HKG)
LAU Wai Sum	HKG		

000 s1 / 001 s1 [05:16]



Mandurah Junior Oceania Cup 2026

Australia, Mandurah, 3 May 2026

-57 kg

Women (3)

Num.	Competitor		1	2	3	Wins	Points
1.	KELLY Oren	AUS		100	100	2	200
2.	KNIGHTS Olivia	AUS	0		0	0	0
3.	LAU Wan Lok	HKG	10	100		1	110

KELLY Oren	AUS	1	KELLY O. (AUS)
KNIGHTS Olivia	AUS		

022 s0 / 000 s1 [02:34]

FINAL RESULTS	
1. KELLY Oren	AUS
2. LAU Wan Lok	HKG

KELLY Oren	AUS	2	KELLY O. (AUS)
LAU Wan Lok	HKG		

020 s0 / 010 s0 [00:55]

KNIGHTS Olivia	AUS	3	LAU W. (HKG)
LAU Wan Lok	HKG		

000 s1 / 020 s0 [02:47]

KELLY Oren	AUS	4	KELLY O. (AUS)
LAU Wan Lok	HKG		

100 s1 / 001 s0 [01:13]



Mandurah Junior Oceania Cup 2026

Australia, Mandurah, 3 May 2026

-63 kg

Women (2)

Num.	Competitor		1	2	Wins	Points
1.	TANDEAN Bianca	AUS		100	1	100
2.	SIMES Kayla	AUS	0		0	0

TANDEAN Bianca	AUS
SIMES Kayla	AUS

1

TANDEAN B. (AUS)

103 s0 / 000 s2 [03:55]

FINAL RESULTS	
1. TANDEAN Bianca	AUS



Mandurah Junior Oceania Cup 2026

Australia, Mandurah, 3 May 2026

-78 kg

Women (1)

Num.	Competitor		Wins	Points
1.	NOURAFSHAN Anita	 AUS	0	0

FINAL RESULTS

1. NOURAFSHAN Anita AUS 

Num.	Competitor		1	2	3	Wins	Points
1.	COMMERFORD Sophia	AUS		0	1	0	1
2.	NAE Kayla	AUS	100		100	2	200
3.	ALALIANE Loloa	KSA	2	0		1	2

COMMERFORD Sophia	AUS	1	NAE K. (AUS)
NAE Kayla	AUS		

000 s0 / 020 s0 [00:26]

FINAL RESULTS	
1. NAE Kayla	AUS
2. ALALIANE Loloa	KSA

COMMERFORD Sophia	AUS	2	ALALIANE L. (KSA)
ALALIANE Loloa	KSA		

001 s0 / 002 s2 [04:00]

NAE Kayla	AUS	3	NAE K. (AUS)
ALALIANE Loloa	KSA		

020 s0 / 000 s0 [00:38]

NAE Kayla	AUS	4	NAE K. (AUS)
ALALIANE Loloa	KSA		

101 s0 / 000 s0 [00:51]