



Event Report

Faro Millennium Team Cadet European Cup 2026, 23-24 May 2026

Event Report

582 competitors from 31 nations

349 Men

233 Women

59.97%

40.03%

-50 kg	-55 kg	-60 kg	-66 kg	-73 kg	-81 kg	-90 kg	+90 kg	Men
36	48	62	64	58	39	27	15	349

-40 kg	-44 kg	-48 kg	-52 kg	-57 kg	-63 kg	-70 kg	+70 kg	Women
8	19	35	51	38	35	26	21	233

Continent	AJU	JUA	EJU	OJU	PJC	OTH	Total
Nations	1	1	23	1	5		31
Competitors	1	1	527	10	43		582

Schedule	Day 1	Day 2
Date	23 May	24 May
Start	09:00	09:00
End	17:45	15:36
Finals start	18:15	16:00
Finals end	20:10	17:50



-50 kg		
1	MEHABRA Ismael	ITA
2	LOPEZ PEREIRA Hugo	ESP
3	BONATO Arthur	BRA
3	MARTINELLI Massimo	ITA
5	MORIN Lucas	FRA
5	KOZAK Matus	SVK
7	BELKOUK Walid	FRA
7	ZANELLA Emrick	FRA

-55 kg		
1	MARTINI Luca	ITA
2	PETROSINO Errico	ITA
3	DE LAURENTIS Mattia	ITA
3	DI NATALE Andrea	ITA
5	NGUYEN Doan	FRA
5	GUTU Nichita	MDA
7	MALIC Nelu	MDA
7	BIOSCA GARCIA Renat	ESP

-60 kg		
1	CENA Federico	ITA
2	MIGUNOV GOMEZ Maksim	ESP
3	DODERO Andre	BRA
3	FALCAO Rafael	BRA
5	HRISTOV Emo	BUL
5	JAAFAR Mahmoud	BUL
7	SOALHEIRO Afonso	POR
7	CASTRO PAMPIN Raul	ESP

-66 kg		
1	GABAYEV Yacine	BEL
2	CIUFFREDA Andrea	ITA
3	GOMEZ ANTONA Javier	ESP
3	TODOROV Vladimir	BUL
5	MOGA Vladislav	MDA
5	RADOSEVIC Ognjen	MNE
7	SOARES Antonio	POR
7	DIMITROV Samuil	BUL

-73 kg		
1	NIKOLCHEV Ivan	BUL
2	GAYOL GRANDA Gonzalo	ESP
3	BAHIENSE Henrique	BRA
3	ANCKAERT Timeo	BEL
5	BASSO Gabriele	ITA
5	CECI Emiliano	ITA
7	DRIDI Sosthene	FRA
7	BELMONT Leandre	FRA

-81 kg		
1	COSERIC Egor	MDA
2	VALCANERAS BLANES Toni	ESP
3	MELLO Yago	BRA
3	MATHUES Sid	BEL
5	MUGNERET Joshua	FRA
5	PARISI Cristian	ITA
7	SILVA Vicente	POR
7	ALIKHANOV Amir	EST

-90 kg		
1	FERNANDEZ CALERO Pablo	ESP
2	FOGAM KAMENI Yanis	FRA
3	SOUSA Heitor	BRA
3	PALMA Joao Gabriel	BRA
5	KELLY Akos	AUS
5	DE NARDI Arthur	BRA
7	ZUCCHERI Leonardo	ITA
7	TRUUVERK Huud-Keerit	EST

+90 kg		
1	VALKOV Tsvetomir	BUL
2	PEREIRA Jose Paulo	BRA
3	LALIASHVILI Giorgi	ESP
3	ROSA Marcus	BRA
5	LABATE Federico	ITA
5	ENDELADZE Teimurazi	ITA
7	LODDES Romet	EST
7	BAYRAMOV VOZNESENKY Rafael Liberty	ESP



-40 kg		
1	TOKMAK Havva Sena	TUR
2	ALCANTARA Ana Mikaele	BRA
3	KARAKAZAN Elcin	TUR
3	SARRAIL Emma	FRA
5	MARTINS Julia	BRA
5	COSTA CABANA Candela	ESP

-44 kg		
1	FERRO Aurora	ITA
2	PEETERS Fenne	BEL
3	LONGO Sofia	ITA
3	VALVERDE DURAN Claudia	ESP
5	TURSI Chiara	ITA
5	YILMAZTURK Yagmur	TUR
7	MONZO PASCUAL Marta	ESP
7	MARINO Ilaria	ITA

-48 kg		
1	STORIONE Ludovica	ITA
2	MONTALBANO Aurora	ITA
3	SANTOS Micaela	BRA
3	IVALDI Beatrice	ITA
5	TRANVOUEZ Alyssa	FRA
5	IMHOF Giovanna	BRA
7	TESI Cecilia	ITA
7	COOK Abbey	AUS

-52 kg		
1	VADOVICOVA Vivien	SVK
2	MARIELLO Matilda	ITA
3	BOSKUP Aysenur	TUR
3	HIROSE Rika	AUS
5	ROBLES GASQUE Mar	ESP
5	SIMIC Tea	BIH
7	CHIRON Alexandra	MDA
7	CADIGNAN Oriane	FRA

-57 kg		
1	PEREIRA Gabriela	BRA
2	BELHADI Saliha	FRA
3	LOURENCO Rita	POR
3	CARAVELLO Lisa	AUS
5	SANS GARCIA Emmy	FRA
5	ALONSO FERNANDEZ Sara	ESP
7	MATHOUA Ayana	FRA
7	DOLZA Giulia	ITA

-63 kg		
1	MAIA Manuela	BRA
2	DAFREVILLE Luane	FRA
3	SPAHIC Sejla	MNE
3	YILMAZ Duru	TUR
5	GIORDANO Valeria	ITA
5	BILEN Sevim Margaret	TUR
7	MATUSZEKOVA Petra	SVK
7	ROITBERG Emma	ITA

-70 kg		
1	CAFARO Ginevra Margherita Pia	ITA
2	DEMETERCO Valentina	BRA
3	FAGIANO Clara	ITA
3	TOMBOU Valerie	BEL
5	ZOLEZZI Noemi	ITA
5	OLIVEIRA Alicia	BRA
7	GUIRAL Emma	FRA
7	MBENGUE RUANO Deguene Aisha	ESP

+70 kg		
1	TOLEDO Yasmim	BRA
2	COULIBALY TOURE Ballalo	ESP
3	BALCI Hatice Tuana	TUR
3	OHONISHI Caroline	BRA
5	GNON Jennifer	FRA
5	CHERKELIEVA Maria	BUL
7	MAGASSA FOFANA Sogona	ESP
7	VUIJSTERS Vanessa	NOR



Medals

Faro Millennium Team Cadet European Cup 2026, 23-24 May 2026

Medals

Nations: 12

#	Nation	1. Place	2. Place	3. Place	5. Place	7. Place
1.	ITA Italy	6	4	6	8	5
2.	BRA Brazil	3	3	10	4	
3.	BUL Bulgaria	2		1	3	1
4.	ESP Spain	1	5	3	3	6
5.	BEL Belgium	1	1	3		
6.	TUR Türkiye	1		4	2	
7.	MDA Republic of Moldova	1			2	2
8.	SVK Slovakia	1			1	1
9.	FRA France		3	1	6	7
10.	AUS Australia			2	1	1
11.	MNE Montenegro			1	1	
12.	POR Portugal			1		3
13.	BIH Bosnia and Herzegovina				1	
14.	EST Estonia					3
15.	NOR Norway					1

Official person:



Statistics

Faro Millennium Team Cadet European Cup 2026, 23-24 May 2026

Statistics

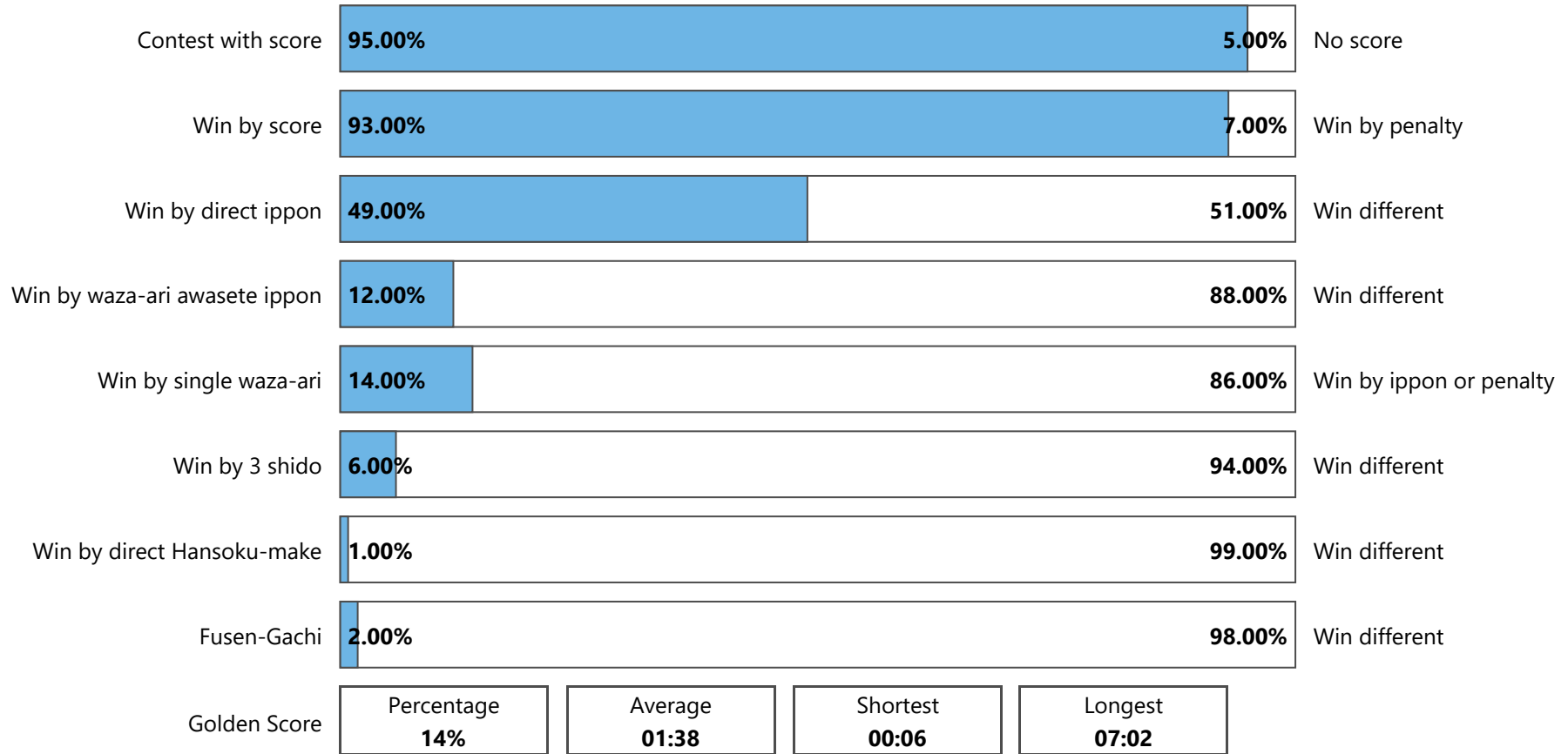



Statistics

Faro Millennium Team Cadet European Cup 2026, 23-24 May 2026

Statistics

	-50	-55	-60	-66	-73	-81	-90	+90	M	-40	-44	-48	-52	-57	-63	-70	+70	W	Total
Competitors	36	48	62	64	58	39	27	15	349	8	19	35	51	38	35	26	21	233	582
Contests	48	60	77	78	69	53	36	21	442	11	26	47	62	49	47	36	29	307	749
Wins by Score	40	55	75	71	65	50	34	20	410	10	21	42	59	46	47	33	27	285	695
Wins by Score %	83	92	97	91	94	94	94	95	92.76	91	81	89	95	94	100	92	93	92.83	93
Wins by Penalty	8	5	2	6	4	3	2	1	31	1	5	5	3	3	0	3	2	22	53
Wins by Penalty %	17	8	3	8	6	6	6	5	7.01	9	19	11	5	6	0	8	7	7.17	7
Wins by direct Ippon %	48	50	42	47	61	55	53	57	50.68	45	19	38	55	51	62	36	59	47.56	49
Wins by Waza-ari Awasete Ippon %	8	8	10	17	4	11	8	14	10.18	18	8	17	13	8	21	22	17	15.31	12
Wins by Waza-ari %	4	17	22	14	13	19	14	10	14.93	18	8	15	15	24	9	8	7	13.36	14
Wins by Yuko %	23	17	23	13	16	9	19	14	16.97	9	46	19	13	10	9	25	10	16.61	17
Wins by 3 Shido for opponent %	17	8	1	6	6	2	3	5	5.88	0	19	11	5	4	0	8	7	6.51	6
Wins by direct Hansoku-make %	0	0	1	1	0	4	3	0	0	9	0	0	0	2	0	0	0	0	1
Double HSK %	0	0	0	0	0	0	0	0	0	0	0	0	0	0	0	0	0	0	0
All positive Scores (Yuko + Waza-ari + direct Ippon)	65	113	142	127	121	95	59	32	754	19	40	80	102	77	96	57	40	511	1265
Average Scores per contests	17	8	3	8	6	6	6	5	1.71	9	19	11	5	6	0	8	7	1.66	7
Contests with score %	88	93	99	92	96	100	97	95	95.02	100	85	91	97	96	100	92	93	94.46	95
All penalties (Shido + HSK)	77	78	79	83	65	57	42	25	506	7	56	60	52	62	21	44	30	332	838
Average penalty per contest	1.6	1.3	1.03	1.06	0.94	1.08	1.17	1.19	1.14	0.64	2.15	1.28	0.84	1.27	0.45	1.22	1.03	1.08	1.12
Contests with only penalty %	12	7	1	6	4	0	3	5	4.75	0	15	9	3	4	0	8	7	5.54	5
Number of Osae-komi (Absolute)	20	12	18	26	13	8	7	4	108	9	6	20	17	11	13	10	12	98	206
Osae-komi no score %	45.00	41.67	27.78	34.62	38.46	25.00	14.29	75.00	36.11	33.33	33.33	25.00	5.88	27.27	23.08	30.0	33.33	24.49	30.58
Osae-komi Yuko %	25.00	0	16.67	26.92	7.69	37.50	14.29	0	4.52	33.33	16.67	35.00	5.88	0	0	0	8.33	4.23	16.02
Osae-komi Waza-ari %	10.0	16.67	38.89	23.08	23.08	12.50	42.86	25.00	5.66	11.11	16.67	35.00	23.53	27.27	38.46	30.0	41.67	9.45	26.21
Osae-komi Ippon %	20.0	41.67	16.67	15.38	30.77	25.00	28.57	0	5.43	22.22	33.33	5.00	64.71	45.45	38.46	40.0	16.67	10.42	27.18
Direct Hansoku-make	0	0	1	1	0	2	1	0	5	1	0	0	0	1	0	0	0	2	7
Fusen-gachi	0	1	1	0	3	0	0	2	7	1	0	1	0	1	0	2	3	8	15
Doctor call	2	3	0	0	1	1	0	1	8	0	1	0	1	0	0	0	0	2	10
Golden Score %	21	7	17	14	7	13	19	5	13.12	9	27	9	13	20	4	22	17	14.66	14
Golden Score Duration AVG	130.9	128.5	85.46	73	133	107.86	84	142	101.5	108	80.43	84	48	92.1	100	183.5	54.4	94.49	98.44
Golden Score Duration MAX	422	206	191	228	194	240	160	142	422	108	170	171	115	182	176	354	104	354	422



Nations Overview

Faro Millennium Team Cadet European Cup 2026, 23-24 May 2026

Nations

Overview

			-50	-55	-60	-66	-73	-81	-90	+90	M	-40	-44	-48	-52	-57	-63	-70	+70	W	Total	Ref	D	
1.		ANG	Angola				1				1										0	1	0	0
2.		AUS	Australia			3	1		1	2	7			1	1	1					3	10	0	2
3.		BEL	Belgium	1		1	2	3	1	2	10		2	2	1	2	1	1			9	19	1	2
4.		BIH	Bosnia and Herzegovina								0				1	1					2	2	1	1
5.		BRA	Brazil	1	3	2	3	1	2	3	2	17	2		4	1	1	2	3	4	17	34	0	5
6.		BUL	Bulgaria		1	2	2	1			7					1	1		1		3	10	1	1
7.		CAN	Canada		1	1	1				4			1							1	5	0	1
8.		CRO	Croatia		1			1			2		1		1						2	4	0	2
9.		ESP	Spain	7	10	18	19	15	6	5	3	83	2	5	7	12	8	8	6	5	53	136	2	35
10.		EST	Estonia	2	1	3	3	1	5	3	2	20			1						1	21	0	5
11.		FRA	France	8	7	5	9	12	4	4	1	50	2		5	9	5	5	6	3	35	85	0	41
12.		GBR	Great Britain		1						1				1						1	2	0	0
13.		ISR	Israel								0			1							1	1	0	1
14.		ITA	Italy	10	11	11	8	11	9	3	2	65		6	5	7	7	6	3	1	35	100	0	35
15.		KGZ	Kyrgyzstan			1					1										0	1	0	1
16.		LTU	Lithuania							1	1										0	1	0	1
17.		LUX	Luxembourg		1						1										0	1	0	2
18.		MDA	Republic of Moldova	1	3		1		1		6				2	1					3	9	1	1
19.		MEX	Mexico			2					2										0	2	0	0
20.		MNE	Montenegro				1				1						1				1	2	0	2
21.		NOR	Norway	1			1	1	1		4				1					1	2	6	0	1
22.		POL	Poland				2	1		1	4										0	4	1	1
23.		POR	Portugal	3	5	12	8	8	7	3	3	49		4	6	10	8	7	5	4	44	93	11	43
24.		PUR	Puerto Rico		1						1										0	1	0	0
25.		ROU	Romania		1	1	1	1	1		5					1					1	6	0	3
26.		SMR	San Marino		1			1			2										0	2	0	1
27.		SRB	Serbia					1	1		2			1					1		2	4	0	1
28.		SVK	Slovakia	2							2				1		2	1			4	6	0	2
29.		TUR	Türkiye								0	2	1	1	2	2	2	1	1		12	12	0	3
30.		UKR	Ukraine								0				1						1	1	0	0
31.		USA	United States of America				1				1										0	1	0	1
				36	48	62	64	58	39	27	15	349	8	19	35	51	38	35	26	21	233	582	18	194

Total: 582 competitors from 31 countries and 5 continents



Faro Millennium Team Cadet European Cup 2026

Portugal, Faro/Algarve, 23-24 May 2026

-50 kg

Men (36)

POOL A

BONATO Arthur	BRA	1	BONATO A. (BRA)
MIDRIGAN Bogdan	MDA	2	MIDRIGAN B. (MDA)
NGUYEN Gia Vinh	FRA	3	LOPEZ PEREIRA H. (ESP)
LOPEZ PEREIRA Hugo	ESP	3	000 s0 / 102 s0 [04:00]
LATTANZI Mattia	ITA	4	LATTANZI M. (ITA)
MARKOVICS Adam	SVK	5	MARKOVICS A. (SVK)
FONMARTIN Bastien	FRA	6	FONMARTIN B. (FRA)
AMADIO Kevin	ITA	7	AMADIO K. (ITA)
SOLER VELASCO Adrian	ESP	8	SOLER VELASCO A. (ESP)

POOL B

KOZAK Matus	SVK	9	KOZAK M. (SVK)
PALHINHA Guilherme	POR	10	PALHINHA G. (POR)
BELKOUK Walid	FRA	11	BELKOUK W. (FRA)
LONGOBARDI Gabriel	ITA	12	LONGOBARDI G. (ITA)
LATTANZI Ruben	ITA	13	LATTANZI R. (ITA)
TRISBERG Ravo	EST	14	BERNUZ H. (FRA)
BERNUZ Hugo	FRA	14	000 s0 / 101 s0 [02:49]
ALVAREZ MORA Daniel	ESP	15	ALVAREZ MORA D. (ESP)
FASTUCA Andrea	ITA	16	FASTUCA A. (ITA)

POOL C

MEHABRA Ismael	ITA	17	MEHABRA I. (ITA)
RUIZ BLASCO Santiago	ESP	18	RUIZ BLASCO S. (ESP)
COME Erwann	FRA	19	QUINTINO A. (POR)
QUINTINO Armando	POR	19	010 s1 / 100 s0 [01:14]
MOUSSAID Mehdi	BEL	20	MOUSSAID M. (BEL)
ZUBETS Rodion	EST	21	ZUBETS R. (EST)
LO VERSO Giulio	ITA	22	LO VERSO G. (ITA)
CERRILLO LOPEZ Mateo	ESP	23	CERRILLO LOPEZ M. (ESP)
ZANELLA Emrick	FRA	24	ZANELLA E. (FRA)

POOL D

ANTONACCI Sebastiano Gabriele	ITA	25	ANTONACCI S. (ITA)
DE NANTES Octave	FRA	26	DE NANTES O. (FRA)
MARTINELLI Massimo	ITA	27	MARTINELLI M. (ITA)
POLO LAGUNA Simon	ESP	28	POLO LAGUNA S. (ESP)
YAGUE LANCHA Ruben	ESP	29	YAGUE LANCHA R. (ESP)
KJOLNER Caspian	NOR	30	ALVES A. (POR)
ALVES Andre Henrique	POR	30	000 s0 / 100 s0 [01:22]
PELLICCIA Diego Fabrizio	ITA	31	PELLICCIA D. (ITA)
MORIN Lucas	FRA	32	MORIN L. (FRA)

REPECHAGE

NGUYEN G. (FRA)	61	LATTANZI M. (ITA)	61	BONATO A. (BRA)	65	BONATO A. (BRA)	69	BONATO A. (BRA)
LATTANZI M. (ITA)		BONATO A. (BRA)		AMADIO K. (ITA)		AMADIO K. (ITA)		100 s1 / 000 s1 [01:50]
PALHINHA G. (POR)	62	PALHINHA G. (POR)	62	BELKOUK W. (FRA)	66	BELKOUK W. (FRA)	70	BELKOUK W. (FRA)
		BELKOUK W. (FRA)		ALVAREZ MORA D. (ESP)		ALVAREZ MORA D. (ESP)		000 s0 / 100 s0 [01:25]
RUIZ BLASCO S. (ESP)	63	RUIZ BLASCO S. (ESP)	63	QUINTINO A. (POR)	67	QUINTINO A. (POR)	71	ZANELLA E. (FRA)
		QUINTINO A. (POR)		ZANELLA E. (FRA)		ZANELLA E. (FRA)		001 s1 / 000 s1 [04:00]
PELLICCIA D. (ITA)	64	PELLICCIA D. (ITA)	64	YAGUE LANCHA R. (ESP)	68	YAGUE LANCHA R. (ESP)	72	MARTINELLI M. (ITA)
		YAGUE LANCHA R. (ESP)		MARTINELLI M. (ITA)		MARTINELLI M. (ITA)		000 s0 / 110 s0 [01:33]

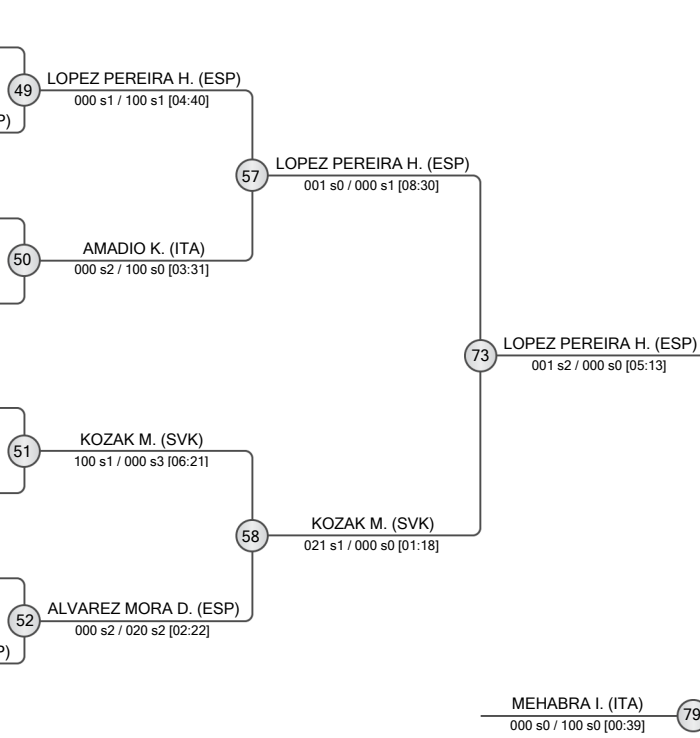

FINAL RESULTS		
1.	MEHABRA Ismael	ITA
2.	LOPEZ PEREIRA Hugo	ESP
3.	BONATO Arthur	BRA
3.	MARTINELLI Massimo	ITA
5.	MORIN Lucas	FRA
5.	KOZAK Matus	SVK
7.	BELKOUK Walid	FRA
7.	ZANELLA Emrick	FRA





Faro Millennium Team Cadet European Cup 2026

Portugal, Faro/Algarve, 23-24 May 2026

-60 kg

Men (62)

POOL A

	KELLY Kaian	AUS
	ALVAREZ LOPEZ Kevin	ESP
	LEONARD Felix	CAN
	LLENA CARDIL Ivan	ESP
	MARMIER Joshua	FRA
	SOALHEIRO Afonso	POR
	VANARA Simone	ITA
	CARABOTTO Gabriele	ITA
	BRAGA Joao	POR
	KOLOSSOV Kristo	EST
	MIGUNOV GOMEZ Maksim	ESP
	SALA Filippo	ITA
	MEDJAHED Adem	FRA
	SANCES TURON Max	ESP
	CABEDAL Guilherme	POR

1	KELLY K. (AUS)	33	KELLY K. (AUS)
2	LEONARD F. (CAN)	000 s0 / 100 s0 [02:28]	100 s0 / 000 s0 [00:26]
3	MARMIER J. (FRA)	000 s1 / 111 s0 [02:20]	SOALHEIRO A. (POR)
4	SOALHEIRO A. (POR)	000 s1 / 010 s1 [04:00]	34
5	CARABOTTO G. (ITA)	020 s0 / 000 s0 [03:17]	MIGUNOV GOMEZ M. (ESP)
6	MIGUNOV GOMEZ M. (ESP)	000 s0 / 001 s0 [04:00]	35
7	MEDJAHED A. (FRA)	000 s0 / 001 s2 [04:00]	36
8	SANCES TURON M. (ESP)	110 s0 / 000 s0 [03:56]	

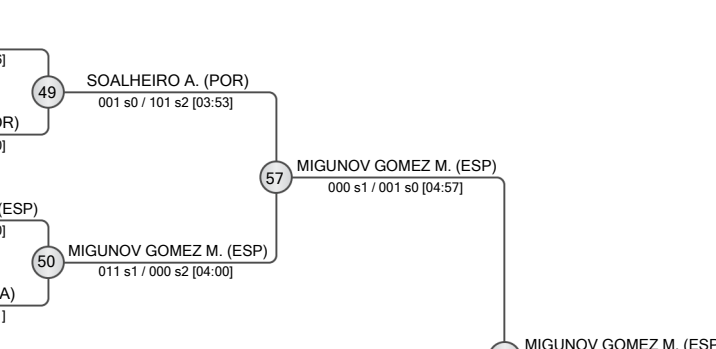

POOL B

	CHOI Isaac	AUS
	ESPANA SANTAMARIA Izan	ESP
	OJA Jan Rasmus	EST
	IVANCEA Daniel	ESP
	CRESPO PEREZ Saul	ESP
	SFARLEA Andrei	ROU
	FASCETTO SIVILLO Gianpaolo	ITA
	SERRANO Joao	POR
	FALCAO Rafael	BRA
	MERA CARMONA Aaron	ESP
	HRISTOV Emo	BUL
	MOREIRA Joao	POR
	NARANJO MILLAN Arnau	ESP
	CHORNYI Davyd	ITA
	PAULA Lourenco	POR
	NICOLAS Thibault	FRA

9	CHOI I. (AUS)	37	CHOI I. (AUS)
10	IVANCEA D. (ESP)	010 s0 / 001 s0 [04:00]	001 s2 / 000 s0 [04:00]
11	SFARLEA A. (ROU)	010 s0 / 011 s0 [04:00]	FASCETTO SIVILLO G. (ITA)
12	FASCETTO SIVILLO G. (ITA)	000 s0 / 101 s1 [03:14]	38
13	FALCAO R. (BRA)	010 s2 / 000 s0 [04:11]	FALCAO R. (BRA)
14	HRISTOV E. (BUL)	100 s0 / 000 s3 [06:32]	39
15	CHORNYI D. (ITA)	000 s0 / 100 s0 [01:08]	40
16	NICOLAS T. (FRA)	000 s0 / 100 s0 [00:51]	

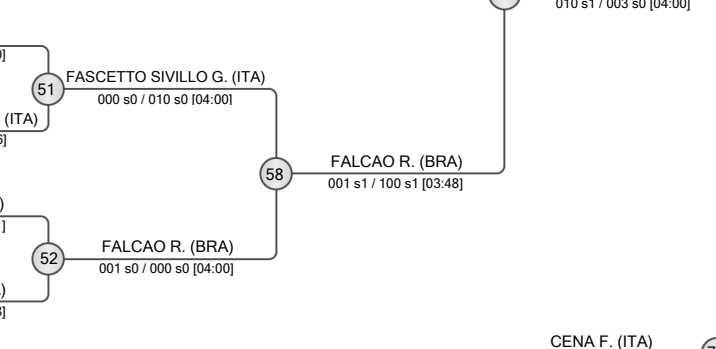

POOL C

	CRUZALTA APODACA Arath	MEX
	FARIA Simao	POR
	RIGOTE RODRIGUEZ Eusebio	ESP
	DODERO Andre	BRA
	CASTRO PAMPIN Raul	ESP
	ADYLBKOV Riccardo	ITA
	ADYLBKOV Alymbek	KGZ
	MONTES OLIVA Lucas	ESP
	FRUTIER Nolan	FRA
	MINUTILLO Alessio	ITA
	LOURO Martim	POR
	PULIDO Joao	POR
	TALLEDO Gabriel	AUS
	SANCHEZ GARCIA Miguel	ESP
	SONZOGNI Giulian	ITA

17	CRUZALTA APODACA A. (MEX)	41	CRUZALTA APODACA A. (MEX)
18	RIGOTE RODRIGUEZ E. (ESP)	000 s1 / 002 s0 [04:00]	010 s2 / 000 s0 [04:00]
19	DODERO A. (BRA)	100 s0 / 000 s0 [03:14]	DODERO A. (BRA)
20	ADYLBKOV A. (KGZ)	000 s1 / 111 s2 [03:54]	42
21	MONTES OLIVA L. (ESP)	011 s0 / 001 s0 [04:34]	43
22	LOURO M. (POR)	000 s1 / 101 s1 [04:00]	44
23	PULIDO J. (POR)	011 s1 / 001 s1 [04:00]	
24	SANCHEZ GARCIA M. (ESP)	100 s0 / 010 s0 [01:28]	

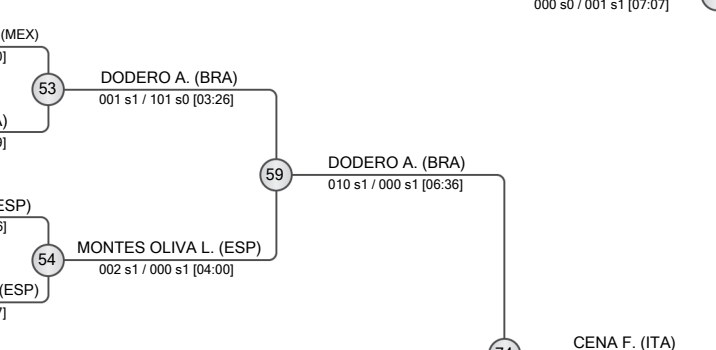

POOL D

	TERAN VELAZQUEZ Ricardo Manuel	MEX
	MORATA CRUZ Daniel	ESP
	AZARUMYAN Aren	EST
	MAGGIA-ASMAKER Robinson	FRA
	MORETTI Mirko	ITA
	HIDALGO ROJO Alejandro	ESP
	DE VICENTE HERNANDO Marco	ESP
	FRAZAO Mateus	POR
	JAAFAR Mahmoud	BUL
	CENA Federico	ITA
	NEVES Pedro	POR
	FLORES TOBAR Daniel	ESP
	CHIARRONI CUTILLAS Alejandro	ESP
	HENSSENS Noah	BEL
	PACHECO Martim	POR
	GESUELE Emanuele	ITA

25	TERAN VELAZQUEZ R. (MEX)	45	TERAN VELAZQUEZ R. (MEX)
26	MAGGIA-ASMAKER R. (FRA)	000 s1 / 001 s1 [04:00]	001 s2 / 000 s0 [04:00]
27	MORETTI M. (ITA)	110 s0 / 000 s0 [00:38]	MORETTI M. (ITA)
28	FRAZAO M. (POR)	000 s0 / 010 s0 [04:00]	46
29	CENA F. (ITA)	001 s0 / 002 s1 [05:53]	47
30	NEVES P. (POR)	010 s0 / 000 s1 [04:00]	48
31	HENSSENS N. (BEL)	000 s0 / 100 s0 [00:41]	
32	GESUELE E. (ITA)	000 s0 / 021 s0 [03:03]	

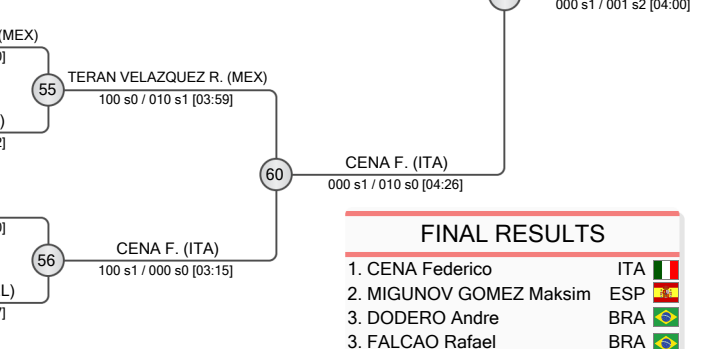

FINAL RESULTS		
1.	CENA Federico	ITA
2.	MIGUNOV GOMEZ Maksim	ESP
3.	DODERO Andre	BRA
3.	FALCAO Rafael	BRA
5.	HRISTOV Emo	BUL
7.	JAAFAR Mahmoud	BUL
7.	SOALHEIRO Afonso	POR
7.	CASTRO PAMPIN Raul	ESP

REPECHAGE

61	KOLOSSOV K. (EST)	65	MEDJAHED A. (FRA)
62	CARABOTTO G. (ITA)	66	HRISTOV E. (BUL)
63	MERA CARMONA A. (ESP)	67	CASTRO PAMPIN R. (ESP)
64	HRISTOV E. (BUL)	68	JAAFAR M. (BUL)

65	MEDJAHED A. (FRA)	69	SOALHEIRO A. (POR)
66	HRISTOV E. (BUL)	70	HRISTOV E. (BUL)
67	CASTRO PAMPIN R. (ESP)	71	CASTRO PAMPIN R. (ESP)
68	JAAFAR M. (BUL)	72	JAAFAR M. (BUL)

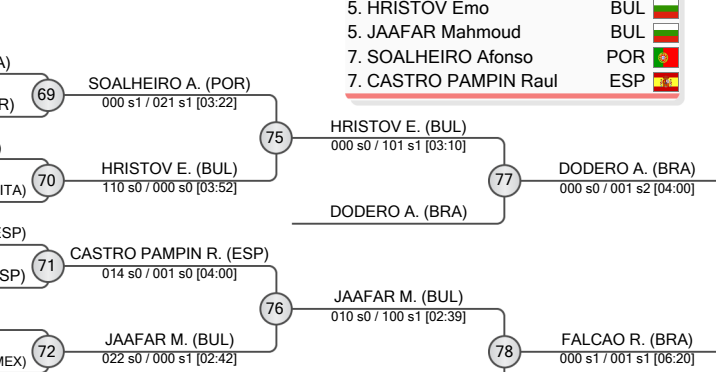



Faro Millennium Team Cadet European Cup 2026

Portugal, Faro/Algarve, 23-24 May 2026

-66 kg

Men (64)

POOL A

USA	LIMA Daniel	1	LIMA D. (USA)	001 s0 / 000 s2 [04:08]	33	LIMA D. (USA)	100 s0 / 000 s2 [03:27]
BRA	COELHO Joao						
FRA	MODJTABAI Mael	2	MODJTABAI M. (FRA)	100 s0 / 000 s0 [01:12]			
ESP	GRELA ROMERO Samuel						
POL	STASIEWICZ Blazej	3	STASIEWICZ B. (POL)	020 s0 / 000 s0 [03:07]			
ITA	CIUFFREDA Andrea	4	CIUFFREDA A. (ITA)	000 s0 / 001 s0 [04:00]	34	CIUFFREDA A. (ITA)	000 s0 / 001 s0 [04:00]
POR	SOARES Antonio						
ITA	PARLATI Marco	5	PARLATI M. (ITA)	100 s0 / 000 s0 [01:11]			
EST	BEZUGLOV Ilija						
FRA	ROBERT Esteban	6	ROBERT E. (FRA)	100 s0 / 000 s0 [02:02]	35	PARLATI M. (ITA)	100 s0 / 000 s0 [02:02]
ESP	BURLACIU CACALETEANU Vlad Andreas						
POR	COSTA Pedro Henrique	7	COSTA P. (POR)	020 s0 / 000 s0 [01:41]			
ESP	GALAN VILLANUEVA Eric						
ESP	POLO LAGUNA Martin	8	POLO LAGUNA M. (ESP)	000 s0 / 111 s0 [02:41]	36	POLO LAGUNA M. (ESP)	000 s0 / 111 s0 [02:41]
ROU	BALAN David						

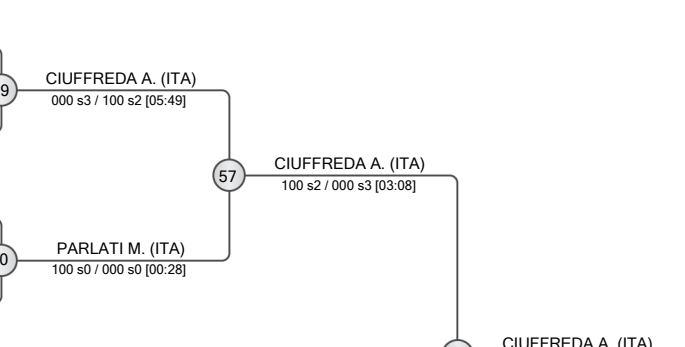

POOL B

BUL	TODOROV Vladimir	9	TODOROV V. (BUL)	020 s0 / 000 s0 [00:44]	37	TODOROV V. (BUL)	020 s0 / 000 s1 [03:58]
ESP	CARDIL BONSON Hector						
EST	KOIV Sebastian	10	KOIV S. (EST)	100 s0 / 000 s0 [00:39]			
CAN	RAESS Corsin						
ITA	DI BENEDETTO Francesco Robert	11	DI BENEDETTO F. (ITA)	011 s1 / 000 s0 [04:00]			
FRA	BERTELLIN Johan						
ESP	SACRISTAN GARCIA Adrian	12	SACRISTAN GARCIA A. (ESP)	101 s0 / 000 s0 [03:20]	38	SACRISTAN GARCIA A. (ESP)	000 s0 / 100 s0 [00:29]
POR	PELLO Flavio						
AUS	ASANO Kento	13	ASANO K. (AUS)	100 s0 / 000 s0 [00:18]			
POR	FRANCA Tomas						
ESP	GOMEZ ANTONA Javier	14	GOMEZ ANTONA J. (ESP)	111 s1 / 000 s2 [01:26]	39	GOMEZ ANTONA J. (ESP)	000 s3 / 100 s2 [04:19]
ITA	MEREU Alessandro						
BRA	GOULART Liam	15	GOULART L. (BRA)	100 s0 / 000 s1 [02:55]	40	GOULART L. (BRA)	010 s2 / 000 s0 [04:00]
ESP	MATEOS SAN VICENTE Diego						
BEL	DZHABELOV Imran	16	DZHABELOV I. (BEL)	022 s0 / 000 s0 [02:29]			
FRA	TAMIETTI Lenzo						

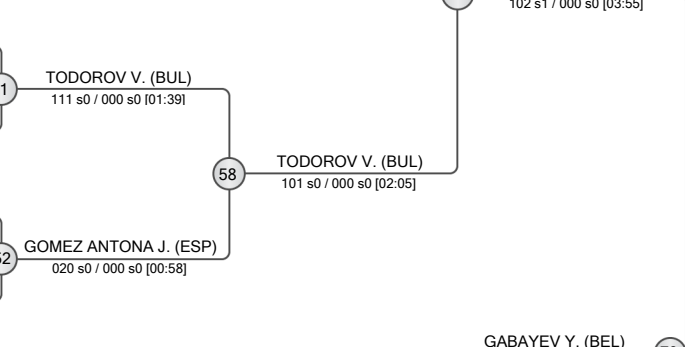

POOL C

BRA	SACILOTTO Bruno	17	SACILOTTO B. (BRA)	010 s0 / 000 s1 [04:00]	41	LIZANA LEON M. (ESP)	000 s0 / 001 s2 [04:36]
ITA	GIORGIANI Alessio						
ESP	LIZANA LEON Marcos	18	LIZANA LEON M. (ESP)	021 s0 / 010 s0 [02:39]			
FRA	SEMENADISSE Quentin						
EST	TROMMEL Sten	19	BLANCO LLUCH P. (ESP)	000 s0 / 101 s2 [07:48]	42	BLANCO LLUCH P. (ESP)	110 s0 / 000 s0 [03:51]
ESP	BLANCO LLUCH Pol						
POR	SILVA Tomas	20	SILVA T. (POR)	002 s1 / 000 s0 [04:00]			
ESP	VAZQUEZ IGLESIAS Martin						
BUL	DIMITROV Samuil	21	DIMITROV S. (BUL)	100 s2 / 000 s1 [06:29]	43	GABAYEV Y. (BEL)	000 s0 / 011 s0 [04:00]
POR	MONGINHO Duarte						
ESP	JIMENEZ PATRON Javier	22	GABAYEV Y. (BEL)	000 s0 / 020 s0 [00:52]			
BEL	GABAYEV Yacine						
ESP	FREIRES MARISCAL Ricardo	23	OVCHARENKO N. (FRA)	000 s0 / 001 s0 [04:00]	44	DI GIANNI F. (ITA)	000 s3 / 111 s0 [02:30]
FRA	OVCHARENKO Nikita						
ANG	NSINGANI Ezequiel	24	DI GIANNI F. (ITA)	000 s1 / 010 s1 [04:00]			
ITA	DI GIANNI Federico						

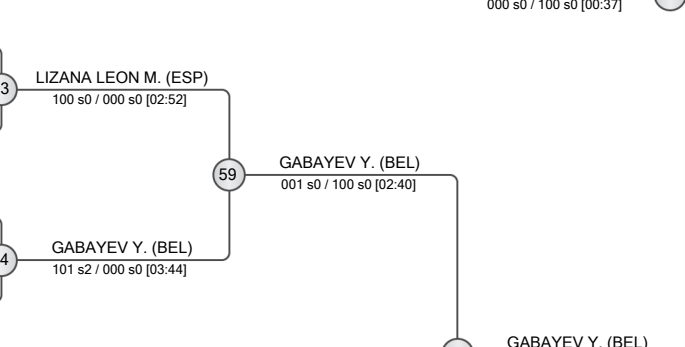

POOL D

POL	WISNIEWSKI Dawid	25	WISNIEWSKI D. (POL)	110 s0 / 011 s0 [02:37]	45	MORANTE DELGADO A. (ESP)	000 s0 / 100 s0 [00:12]
ESP	LAGO PEREZ Pancho						
ESP	MORANTE DELGADO Agustin	26	MORANTE DELGADO A. (ESP)	021 s0 / 010 s0 [02:21]			
ITA	SAMKHARADZE Lazare						
FRA	DESTALMINIL Leo	27	AAMODT A. (NOR)	000 s1 / 010 s1 [04:41]	46	AAMODT A. (NOR)	110 s1 / 001 s0 [04:00]
NOR	AAMODT Axel						
ESP	ROMERO GONZALEZ Fernando	28	LAGES F. (POR)	001 s0 / 101 s1 [03:02]			
POR	LAGES Francisco						
MNE	RADOSEVIC Ognjen	29	RADOSEVIC O. (MNE)	010 s2 / 000 s0 [04:00]	47	RADOSEVIC O. (MNE)	011 s0 / 000 s0 [04:00]
FRA	SERRA Joan						
POR	FARIA Dinis	30	MARANDYAN L. (ESP)	000 s1 / 100 s1 [03:08]			
ESP	MARANDYAN Lemuel						
ESP	ALVAREZ LOPEZ Hugo	31	D ANDREIS L. (ITA)	000 s0 / 100 s0 [00:41]	48	MOGA V. (MDA)	000 s0 / 100 s0 [00:39]
ITA	D ANDREIS Luca						
MDA	MOGA Vladislav	32	MOGA V. (MDA)	100 s0 / 000 s1 [03:38]			
FRA	NIZAR Louay						

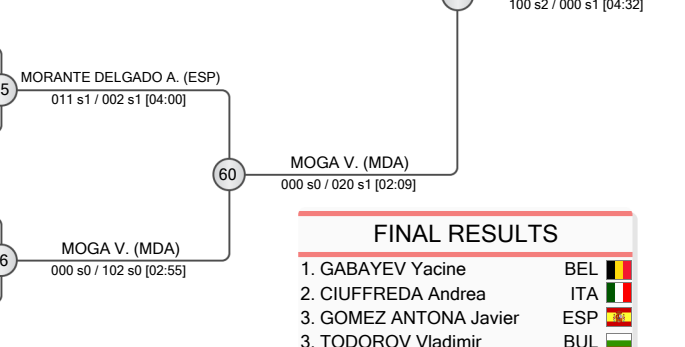

FINAL RESULTS

- GABAYEV Yacine BEL
- CIUFFREDA Andrea ITA
- GOMEZ ANTONA Javier ESP
- TODOROV Vladimir BUL
- MOGA Vladislav MDA
- RADOSEVIC Ognjen MNE
- SOARES Antonio POR
- DIMITROV Samuil BUL

REPECHAGE

POR	SOARES A. (POR)	61	SOARES A. (POR)	100 s1 / 000 H [02:56]	65	LIMA D. (USA)	001 s0 / 000 s1 [04:00]
POL	STASIEWICZ B. (POL)						
ESP	CARDIL BONSON H. (ESP)						
EST	KOIV S. (EST)	62	CARDIL BONSON H. (ESP)	020 s1 / 000 s0 [03:31]			
ESP	JIMENEZ PATRON J. (ESP)						
BUL	DIMITROV S. (BUL)	63	SACRISTAN GARCIA A. (ESP)	000 s0 / 101 s0 [01:40]	66	SACRISTAN GARCIA A. (ESP)	000 s0 / 020 s0 [01:25]
FRA	NIZAR L. (FRA)						
ITA	D ANDREIS L. (ITA)	64	DIMITROV S. (BUL)	000 s0 / 000 s0 [00:00]			
MNE	RADOSEVIC O. (MNE)						
MNE	RADOSEVIC O. (MNE)	68	DI GIANNI F. (ITA)	001 s1 / 000 s2 [04:00]	67	DIMITROV S. (BUL)	001 s1 / 000 s2 [04:00]
ESP	MORANTE DELGADO A. (ESP)						
ITA	PARLATI M. (ITA)	69	LIZANA LEON M. (ESP)	010 s0 / 000 s1 [04:20]	71	LIZANA LEON M. (ESP)	010 s0 / 000 s1 [04:20]
ITA	CIUFFREDA A. (ITA)	73	RADOSEVIC O. (MNE)	000 s3 / 100 s0 [04:52]	76	RADOSEVIC O. (MNE)	000 s3 / 100 s0 [04:52]
BEL	GABAYEV Y. (BEL)	79	MORANTE DELGADO A. (ESP)	111 s0 / 001 s0 [02:19]	72	RADOSEVIC O. (MNE)	111 s0 / 001 s0 [02:19]

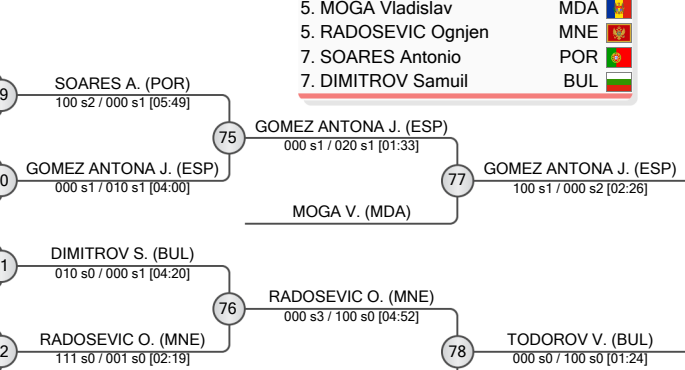



Faro Millennium Team Cadet European Cup 2026

Portugal, Faro/Algarve, 23-24 May 2026

-90 kg

Men (27)

POOL A

	KELLY Akos	AUS
	CLEDJO Mathys	BEL
	PALMA Joao Gabriel	BRA
	SZCZESNIAK Igor	POL
	BURGOS DONCEL Rodrigo	ESP
	LIPPUS Hubert	EST
	AMACIN Marlone	FRA

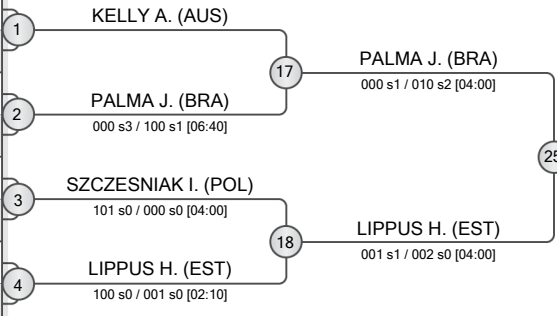

POOL B

	FERNANDEZ CALERO Pablo	ESP
	DOSSO Ilyes	FRA
	BALTAZAR Lucas	POR
	ZUCCHERI Leonardo	ITA
	KHATCHATOURIAN David	LTU
	MAKOLY PRANJKIC Daren	ESP

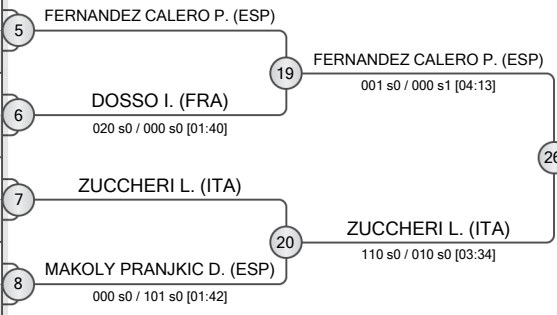

POOL C

	SOUSA Heitor	BRA
	MADDALOZZO Luis	AUS
	SIRIEIX BETIRAC Camille	FRA
	TRUUVVERK Huud-Keerit	EST
	GAMBUZZA Francesco	ITA
	SEGUIN RENDAL Ian	ESP
	MARQUES Cristean	POR

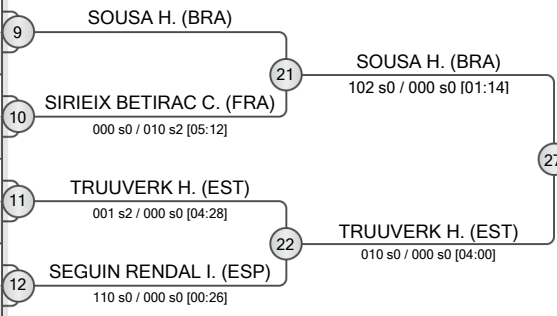

POOL D

	SIGNORINI Nicolo	ITA
	VALVERDE GOMEZ Alberto	ESP
	COSTA Pedro Sardinha	POR
	DE NARDI Arthur	BRA
	FOGAM KAMENI Yanis	FRA
	KONOPLYANYK Nikolai	BEL
	LEETSAR Kaur	EST

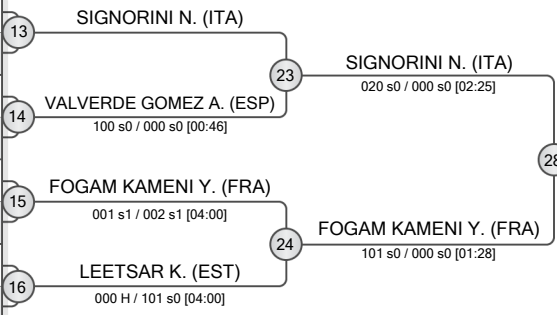

REPECHAGE

CLEDJO M. (BEL)	29	KELLY A. (AUS)	33	KELLY A. (AUS)
KELLY A. (AUS)		LIPPUS H. (EST)		110 s0 / 000 s0 [02:55]
DOSSO I. (FRA)	30	DOSSO I. (FRA)	34	ZUCCHERI L. (ITA)
		ZUCCHERI L. (ITA)		001 s0 / 100 s1 [02:07]
SIRIEIX BETIRAC C. (FRA)	31	SIRIEIX BETIRAC C. (FRA)	35	TRUUVVERK H. (EST)
		TRUUVVERK H. (EST)		000 s2 / 002 s2 [04:00]
DE NARDI A. (BRA)		DE NARDI A. (BRA)	40	DE NARDI A. (BRA)
LEETSAR K. (EST)	32	DE NARDI A. (BRA)		000 s1 / 100 s0 [01:56]
		SIGNORINI N. (ITA)	36	DE NARDI A. (BRA)
				001 s2 / 000 s0 [04:00]

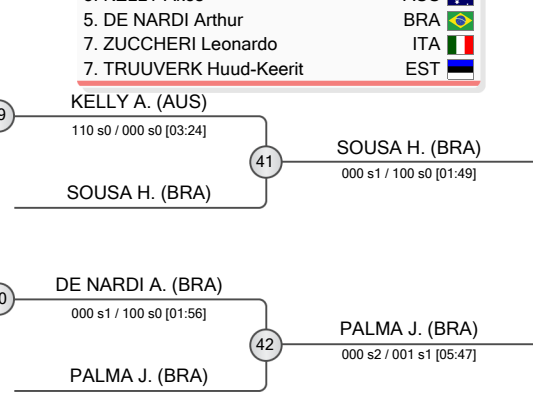

FINAL RESULTS		
1.	FERNANDEZ CALERO Pablo	ESP
2.	FOGAM KAMENI Yanis	FRA
3.	SOUSA Heitor	BRA
3.	PALMA Joao Gabriel	BRA
5.	KELLY Akos	AUS
7.	DE NARDI Arthur	BRA
7.	ZUCCHERI Leonardo	ITA
7.	TRUUVVERK Huud-Keerit	EST





Faro Millennium Team Cadet European Cup 2026

Portugal, Faro/Algarve, 23-24 May 2026

+ 90 kg

Men (15)

POOL A

	PEREIRA Jose Paulo	BRA
	LODDES Romet	EST
	MASCARO GUERRERO Daniel	ESP

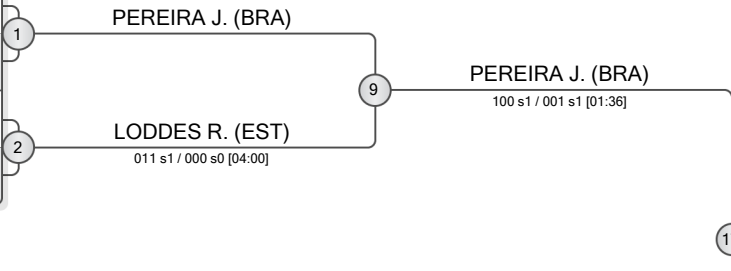

POOL B

	ENDELADZE Teimurazi	ITA
	SUBERLAK Ridley	CAN
	OSTROVSCHII Vladimir	POR
	LALIASHVILI Giorgi	ESP

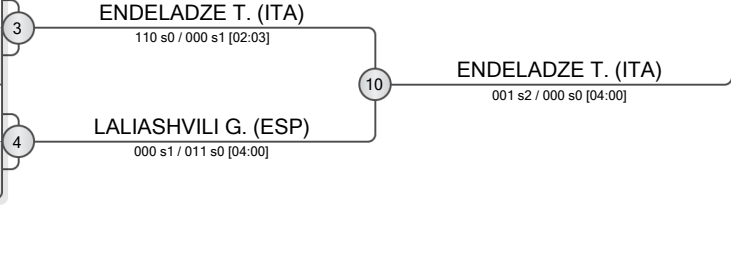

POOL C

	LABATE Federico	ITA
	ARAUJO-DE JESUS Rodrigo	POR
	BAYRAMOV VOZNESENKY Rafael Liberty	ESP
	RAMMO Johan	EST

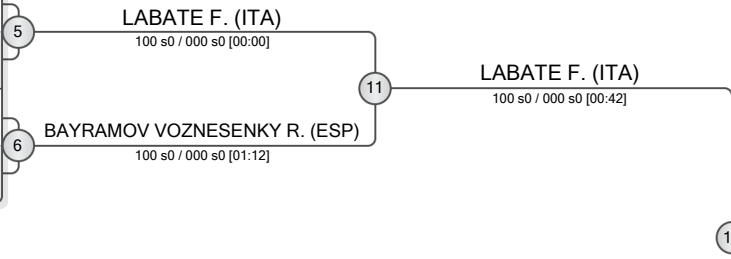

POOL D

	VALKOV Tsvetomir	BUL
	ROSA Marcus	BRA
	SAURA Nathan	FRA
	SANTOS Daniel Rodrigues	POR

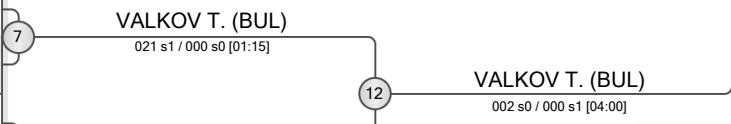

REPECHAGE

LODDES R. (EST)	13
SUBERLAK R. (CAN)	14
LALIASHVILI G. (ESP)	14
ARAUJO-DE JESUS R. (POR)	15
BAYRAMOV VOZNESENKY R. (ESP)	15
ROSA M. (BRA)	16
SANTOS D. (POR)	16

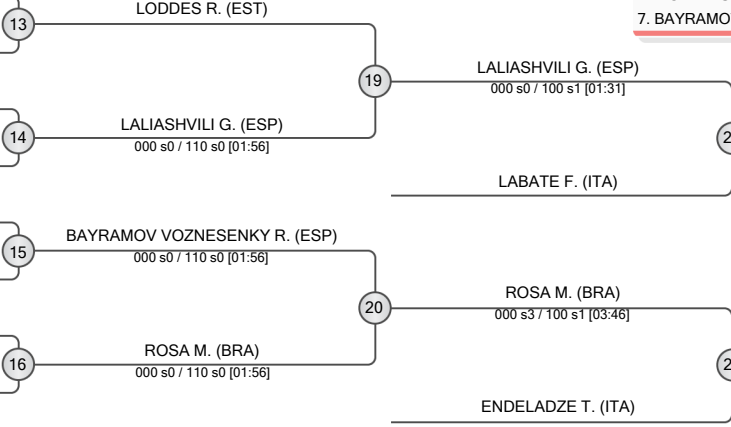

FINAL RESULTS		
1. VALKOV Tsvetomir	BUL	
2. PEREIRA Jose Paulo	BRA	
3. LALIASHVILI Giorgi	ESP	
3. ROSA Marcus	BRA	
5. LABATE Federico	ITA	
5. ENDELADZE Teimurazi	ITA	
7. LODDES Romet	EST	
7. BAYRAMOV VOZNESENKY Rafael Liberty	ESP	





Faro Millennium Team Cadet European Cup 2026

Portugal, Faro/Algarve, 23-24 May 2026

-40 kg

Women (8)

POOL A

TOKMAK Hawva Sena TUR

CALLEJA JARABO Candela ESP

1 TOKMAK H. (TUR)
110 s0 / 000 s0 [02:10]

POOL B

SARRAIL Emma FRA

MARTINS Julia BRA

2 SARRAIL E. (FRA)
001 s1 / 000 s0 [04:00]

POOL C

KARAKAZAN Elcin TUR

COURAJOURD Chloe FRA

3 KARAKAZAN E. (TUR)
021 s0 / 001 s0 [02:37]

POOL D

COSTA CABANA Candela ESP

ALCANTARA Ana Mikaele BRA

4 ALCANTARA A. (BRA)
000 s1 / 101 s0 [02:49]

5 TOKMAK H. (TUR)
011 s1 / 000 s1 [04:00]

6 ALCANTARA A. (BRA)
001 s0 / 100 s0 [01:20]

11 TOKMAK H. (TUR)
100 s0 / 001 H [02:17]

FINAL RESULTS		
1.	TOKMAK Hawva Sena	TUR
2.	ALCANTARA Ana Mikaele	BRA
3.	KARAKAZAN Elcin	TUR
3.	SARRAIL Emma	FRA
5.	MARTINS Julia	BRA
5.	COSTA CABANA Candela	ESP

REPECHAGE

CALLEJA JARABO C. (ESP)

MARTINS J. (BRA)

7 MARTINS J. (BRA)
000 s0 / 100 s0 [00:00]

9 KARAKAZAN E. (TUR)
000 s0 / 010 s0 [04:00]

COURAJOURD C. (FRA)

COSTA CABANA C. (ESP)

8 COSTA CABANA C. (ESP)
000 s0 / 020 s1 [02:55]

10 SARRAIL E. (FRA)
000 s0 / 010 s0 [04:00]





Faro Millennium Team Cadet European Cup 2026

Portugal, Faro/Algarve, 23-24 May 2026

-44 kg

Women (19)

POOL A

	YILMAZTURK Yagmur	TUR
	TURSI Chiara	ITA
	SANCHEZ MAGAZ Ainara	ESP
	HISSETTE Nell	BEL
	GASPAR Matilde	POR

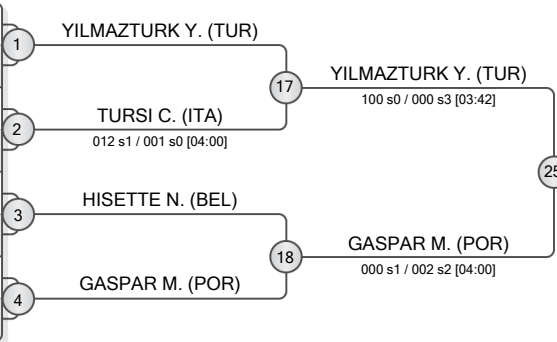

POOL B

	PEETERS Fenne	BEL
	AMORIM Matilde	POR
	LIETI Alice	ITA
	MONZO PASCUAL Marta	ESP
	CIRACI Benedetta	ITA

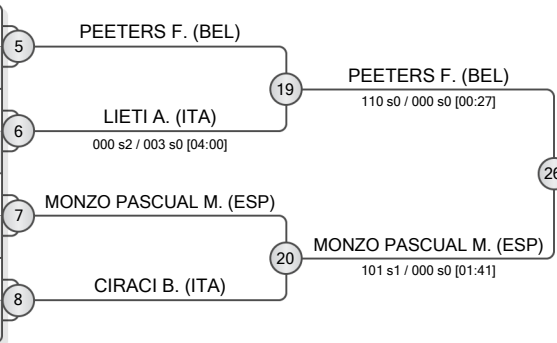

POOL C

	FERRO Aurora	ITA
	ALMENDROS RINCON Ariadna	ESP
	VALVERDE DURAN Claudia	ESP
	PINTO Maria	POR
	FORNAZAR Nola	CRO

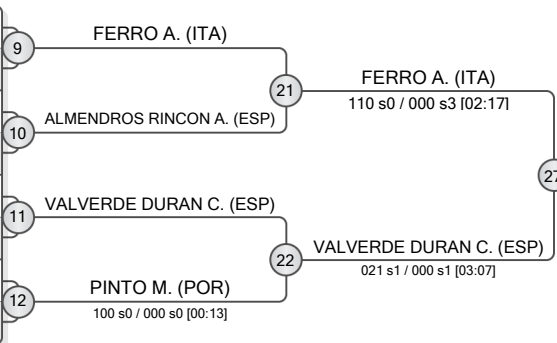

POOL D

	LONGO Sofia	ITA
	PACHECO Ana	POR
	MARINO Ilaria	ITA
	RIVERA FERNANDEZ Sara Mai	ESP

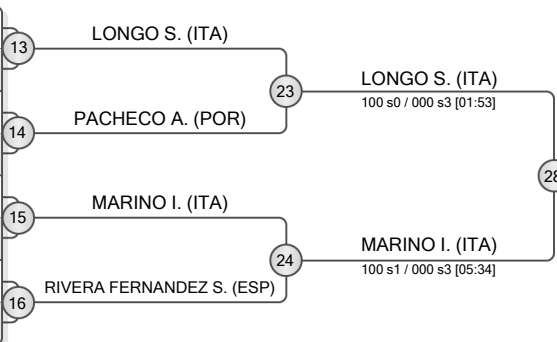

REPECHAGE

	TURSI C. (ITA)	29
	LIETI A. (ITA)	30
	ALMENDROS RINCON A. (ESP)	31
	PACHECO A. (POR)	32
	TURSI C. (ITA)	33
	MONZO PASCUAL M. (ESP)	34
	VALVERDE DURAN C. (ESP)	35
	MARINO I. (ITA)	36

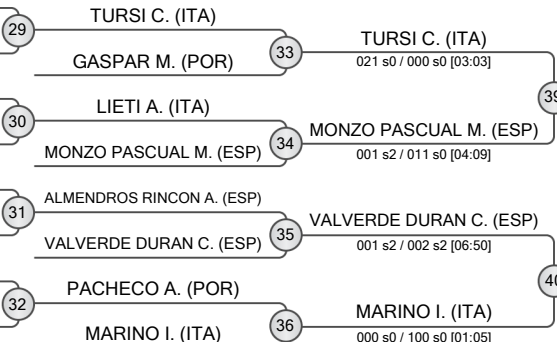

FINAL RESULTS	
1.	FERRO Aurora ITA
2.	PEETERS Fenne BEL
3.	LONGO Sofia ITA
3.	VALVERDE DURAN Claudia ESP
5.	TURSI Chiara ITA
5.	YILMAZTURK Yagmur TUR
7.	MONZO PASCUAL Marta ESP
7.	MARINO Ilaria ITA

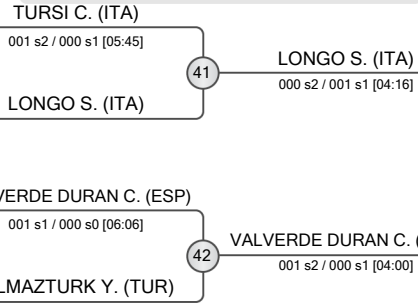



Faro Millennium Team Cadet European Cup 2026

Portugal, Faro/Algarve, 23-24 May 2026

-48 kg

Women (35)

POOL A

IMHOF Giovanna	BRA	1	IMHOF G. (BRA)
TESI Cecilia	ITA	2	TESI C. (ITA)
CARVALHO Mariana	POR	3	CARVALHO M. (POR)
SADABA CORBACHO June	ESP	4	SADABA CORBACHO J. (ESP)
VIEIRA Lena	FRA	5	VIEIRA L. (FRA)
FILIPOVIC Mia	SRB	6	FILIPOVIC M. (SRB)
MATA NUNEZ Marta	ESP	7	MATA NUNEZ M. (ESP)
PEREIRA Guida	POR	8	PEREIRA G. (POR)

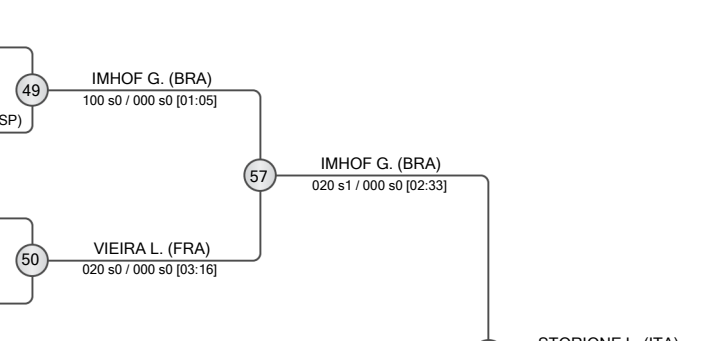

POOL B

STORIONE Ludovica	ITA	9	STORIONE L. (ITA)
TRANVOUEZ Alyssa	FRA	10	TRANVOUEZ A. (FRA)
AVIGDOR Gili Tamar	ISR	11	AVIGDOR G. (ISR)
SOARES Maria	POR	12	HAMRI OULAD AZZOUD D. (ESP)
MIZIARA Maria	BRA	13	MIZIARA M. (BRA)
DUTARTRE Ciara	FRA	14	DUTARTRE C. (FRA)
MARTINEZ Navia	BEL	15	MARTINEZ N. (BEL)
SANTIN MORENO Miriam	ESP	16	SANTIN MORENO M. (ESP)

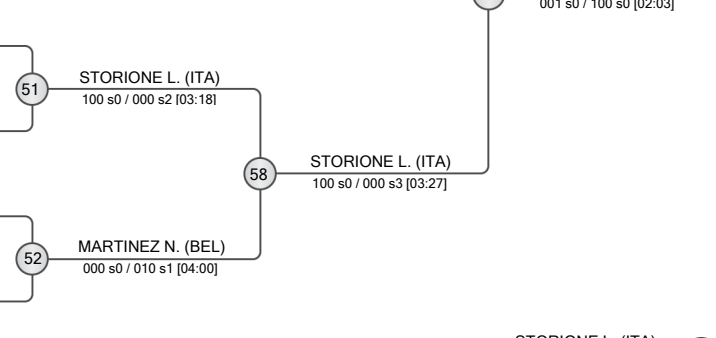

POOL C

MONTALBANO Aurora	ITA	17	MONTALBANO A. (ITA)
CARO NAMYASENKO Carolina	ESP	18	CARO NAMYASENKO C. (ESP)
KAYIR Livanur	TUR	19	KAYIR L. (TUR)
MACIEL Maria	BRA	20	MACIEL M. (BRA)
AZARUMYAN Anna	EST	21	AZARUMYAN A. (EST)
GOIMIER Valentine	FRA	22	GOIMIER V. (FRA)
IVALDI Beatrice	ITA	23	IVALDI B. (ITA)
FRANCO Carolina	POR	24	NUNEZ CAZADO A. (ESP)
NUNEZ CAZADO Andrea	ESP	24	NUNEZ CAZADO A. (ESP)

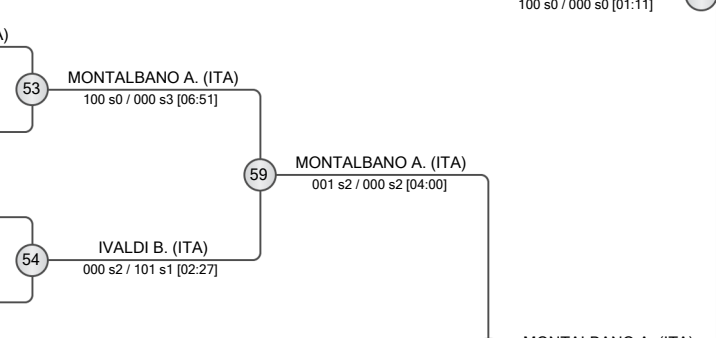

POOL D

COOK Abbey	AUS	25	COOK A. (AUS)
FRANCO Agata	ITA	26	FRANCO A. (ITA)
JNAOUI Celya	FRA	27	JNAOUI C. (FRA)
MORENO TORRES Eva	ESP	28	MORENO TORRES E. (ESP)
GRIGORYAN Viktoria	BEL	29	GRIGORYAN V. (BEL)
SINOGAS Ines	POR	30	SINOGAS I. (POR)
LI Anna	CAN	31	SANTOS M. (BRA)
SANTOS Micaela	BRA	32	SANTOS M. (BRA)
GRECU Beatriz	POR	32	GRECU B. (POR)

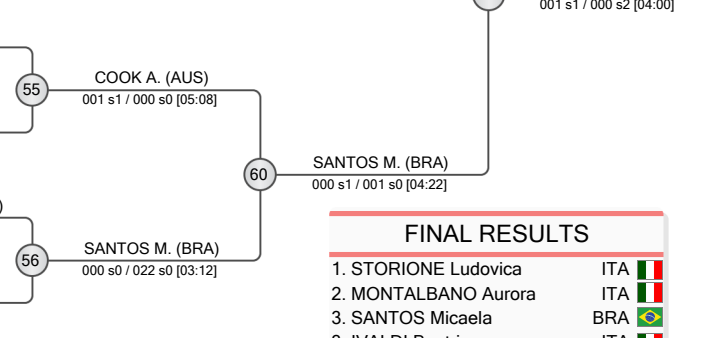

FINAL RESULTS		
1.	STORIONE Ludovica	ITA
2.	MONTALBANO Aurora	ITA
3.	SANTOS Micaela	BRA
3.	IVALDI Beatrice	ITA
5.	TRANVOUEZ Alyssa	FRA
7.	IMHOF Giovanna	BRA
7.	TESI Cecilia	ITA
7.	COOK Abbey	AUS

REPECHAGE

TESI C. (ITA)	61	TESI C. (ITA)
TRANVOUEZ A. (FRA)	62	TRANVOUEZ A. (FRA)
CARO NAMYASENKO C. (ESP)	63	CARO NAMYASENKO C. (ESP)
LI A. (CAN)	64	LI A. (CAN)
GRECU B. (POR)	64	GRECU B. (POR)

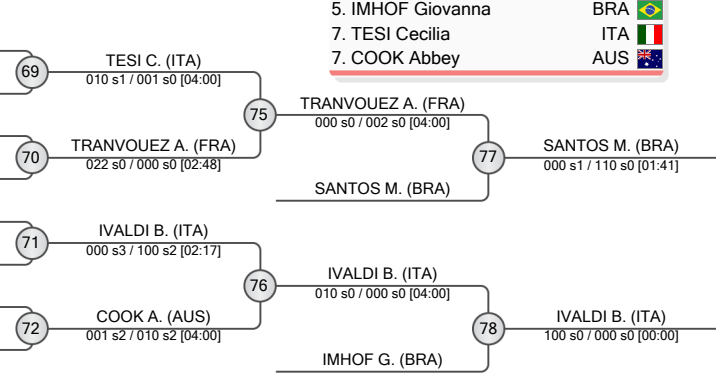



Faro Millennium Team Cadet European Cup 2026

Portugal, Faro/Algarve, 23-24 May 2026

-52 kg

Women (51)

POOL A

CHIRON Alexandra	MDA	1	CHIRON A. (MDA)
MARTHOS Alice	FRA	2	MARTHOS A. (FRA)
ROMERA BARRAGAN Aniana	ESP		
VUKSANOVIC Tena	CRO	3	VUKSANOVIC T. (CRO)
GALINHO Joana	POR		
SANFELIX MONTMANY Laina	ESP	4	SANFELIX MONTMANY L. (ESP)
HIROSE Rika	AUS	5	HIROSE R. (AUS)
DOBROVOLSKI Emma	ITA	6	CALHEIROS D. (POR)
CALHEIROS Diana	POR		
DIAZ NAFAR Carlota	ESP	7	DIAZ NAFAR C. (ESP)
LUDWIG Valentine	FRA		
YILMAZ Betul	TUR	8	YILMAZ B. (TUR)

POOL B

LAVRENOVA Kamila	UKR	9	LAVRENOVA K. (UKR)
TIXIER Line	FRA	10	TIXIER L. (FRA)
DOMINGOS Ines	POR		
REPOLA Maia	ITA	11	REPOLA M. (ITA)
FERREIRA Iris	POR		
PECQUEUX Maee	FRA	12	PECQUEUX M. (FRA)
SOLANO BADIA Sara	ESP		
MARIELLO Matilda	ITA	13	MARIELLO M. (ITA)
ROBLES GASQUE Mar	ESP	14	ROBLES GASQUE M. (ESP)
RUSHFELDT Ariane	NOR		
MARIANO Beatriz	POR		
BOUALEM Norhene	FRA	15	BOUALEM N. (FRA)
SOUSA LAVANDEIRA Zeltia	ESP	16	SOUSA LAVANDEIRA Z. (ESP)

POOL C

GASPAR Sofia	POR	17	GASPAR S. (POR)
CADIGNAN Oriane	FRA	18	CADIGNAN O. (FRA)
ARAGON ANTON Barbara	ESP		
GUION Sofia	ITA	19	GUION S. (ITA)
WELLEKENS Amelie	BEL		
LARANJINHA Violeta	POR	20	LARANJINHA V. (POR)
BOSKUP Aysenur	TUR	21	BOSKUP A. (TUR)
TORRISI Luna	ITA	22	MARTIN TORRES J. (ESP)
MARTIN TORRES Jimena	ESP		
VAINER Xenia	MDA	23	VAINER X. (MDA)
NOURISSON Emma	FRA		
SILVA Noa	POR	24	SILVA N. (POR)
SORIANO PINERO Nora	ESP		

POOL D

VADOVICOVA Vivien	SVK	25	VADOVICOVA V. (SVK)
TERES CEREZA Daniela	ESP	26	GOULART V. (POR)
GOULART Vitoria	POR		
DI RUZZA Emma	ITA	27	OLARRA ERENTXUN J. (ESP)
OLARRA ERENTXUN Janire	ESP		
BELMONT Cassandre	FRA	28	BELMONT C. (FRA)
SIMIC Tea	BIH	29	SIMIC T. (BIH)
CRUZ Giovanna	BRA	30	LOUVET ECHE P. (FRA)
LOUVET ECHE Pauline	FRA		
MAGNANI Guenda	ITA	31	MAGNANI G. (ITA)
SANTOS Carolina	POR		
CALVO LEON Lola	ESP	32	BROADLEY M. (GBR)
BROADLEY Maisie	GBR		

REPECHAGE

CALHEIROS D. (POR)	61	CALHEIROS D. (POR)
ROBLES GASQUE M. (ESP)	62	ROBLES GASQUE M. (ESP)
MARTIN TORRES J. (ESP)	63	MARTIN TORRES J. (ESP)
GOULART V. (POR)	64	GOULART V. (POR)
DIAZ NAFAR C. (ESP)	65	DIAZ NAFAR C. (ESP)
BOUALEM N. (FRA)	66	BOUALEM N. (FRA)
VAINER X. (MDA)	67	VAINER X. (MDA)
GOULART V. (POR)	68	GOULART V. (POR)
DIAZ NAFAR C. (ESP)	69	DIAZ NAFAR C. (ESP)
ROBLES GASQUE M. (ESP)	70	ROBLES GASQUE M. (ESP)
VAINER X. (MDA)	71	VAINER X. (MDA)
GOULART V. (POR)	72	GOULART V. (POR)
CHIRON A. (MDA)	73	CHIRON A. (MDA)
ROBLES GASQUE M. (ESP)	74	ROBLES GASQUE M. (ESP)
CHIRON A. (MDA)	75	CHIRON A. (MDA)
CADIGNAN O. (FRA)	76	CADIGNAN O. (FRA)
CHIRON A. (MDA)	77	CHIRON A. (MDA)
SIMIC T. (BIH)	78	SIMIC T. (BIH)
HIROSE R. (AUS)	79	HIROSE R. (AUS)

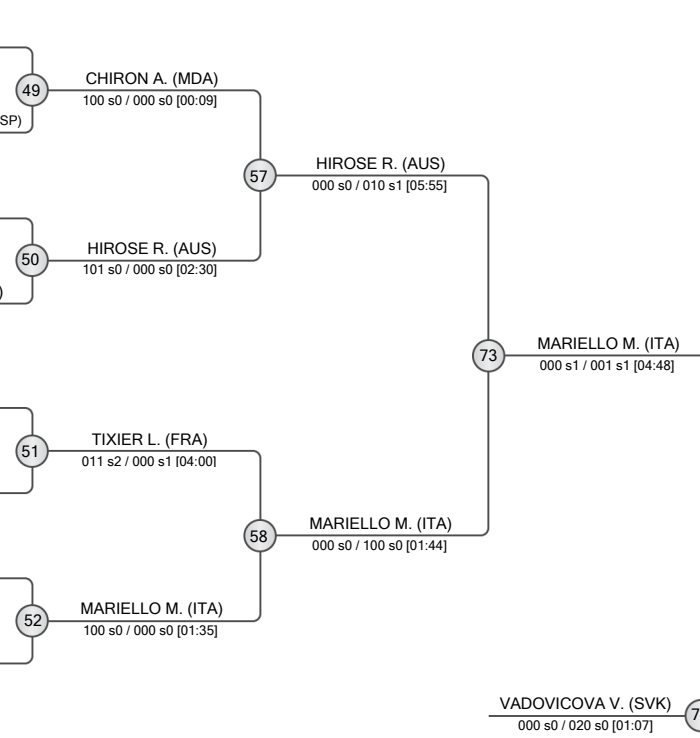

FINAL RESULTS	
1. VADOVICOVA Vivien	SVK
2. MARIELLO Matilda	ITA
3. BOSKUP Aysenur	TUR
3. HIROSE Rika	AUS
5. ROBLES GASQUE Mar	ESP
5. SIMIC Tea	BIH
7. CHIRON Alexandra	MDA
7. CADIGNAN Oriane	FRA





Faro Millennium Team Cadet European Cup 2026

Portugal, Faro/Algarve, 23-24 May 2026

-57 kg

Women (38)

POOL A

1	CARAVELLO Lisa (AUS)	1	CARAVELLO L. (AUS)
2	ALCIBAR MARCILLA Carlota (ESP)	2	PALERMO S. (ITA)
3	PALERMO Sara (ITA)	3	NATARIO M. (POR)
4	MATHOUA Ayana (FRA)	4	MATHOUA A. (FRA)
5	ACTIS Margherita (ITA)	5	ACTIS M. (ITA)
6	PARDO MARTINEZ Carmen (ESP)	6	PARDO MARTINEZ C. (ESP)
7	JANSEN Marie-Lise (BEL)	7	GRUEVA D. (BUL)
8	GRUEVA Dara (BUL)	8	DUARTE I. (POR)

POOL B

9	PEREIRA Gabriela (BRA)	9	PEREIRA G. (BRA)
10	DANIELE Chiara (ITA)	10	DANIELE C. (ITA)
11	FERNANDEZ ARMSTRONG Ela (ESP)	11	FERNANDEZ ARMSTRONG E. (ESP)
12	ANTONIO Beatriz (POR)	12	ANTONIO B. (POR)
13	LOURENCO Rita (POR)	13	LOURENCO R. (POR)
14	FONTANELL Margaux (FRA)	14	FONTANELL M. (FRA)
15	PORRO Ludovica (ITA)	15	PORRO L. (ITA)
16	CRESPO SILVA Carlota (ESP)	16	SEICA Ioana (ROU)

POOL C

17	KILIC Elif (TUR)	17	KILIC E. (TUR)
18	RUSU Maria (MDA)	18	RUSU M. (MDA)
19	GUERRERO PADIN Ines (ESP)	19	GUERRERO PADIN I. (ESP)
20	FERREIRA Maria (POR)	20	FERREIRA M. (POR)
21	BELHADI Saliha (FRA)	21	BELHADI S. (FRA)
22	TOPCU Ezgi (TUR)	22	TOPCU E. (TUR)
23	FOSSATI Annachiara (ITA)	23	FOSSATI A. (ITA)
24	ALARCAO Matilde (POR)	24	ALARCAO M. (POR)

POOL D

25	CHERNOVA Carina (POR)	25	CHERNOVA C. (POR)
26	MAGNANI Mia (ITA)	26	MAGNANI M. (ITA)
27	RENARD Jade (FRA)	27	RENARD J. (FRA)
28	TEZANOS CLAVERO Teresa Lourdes (ESP)	28	TEZANOS CLAVERO T. (ESP)
29	ABU JAHRUR Ines (BEL)	29	ABU JAHRUR I. (BEL)
30	DOLZA Giulia (ITA)	30	DOLZA G. (ITA)
31	GILA TORMO Dara (ESP)	31	GILA TORMO D. (ESP)
32	SIMIC Mia (BIH)	32	SIMIC M. (BIH)

REPECHAGE

61	PALERMO S. (ITA)	61	PALERMO S. (ITA)
62	DANIELE C. (ITA)	62	DANIELE C. (ITA)
63	FERREIRA M. (POR)	63	FERREIRA M. (POR)
64	SIMIC M. (BIH)	64	SIMIC M. (BIH)

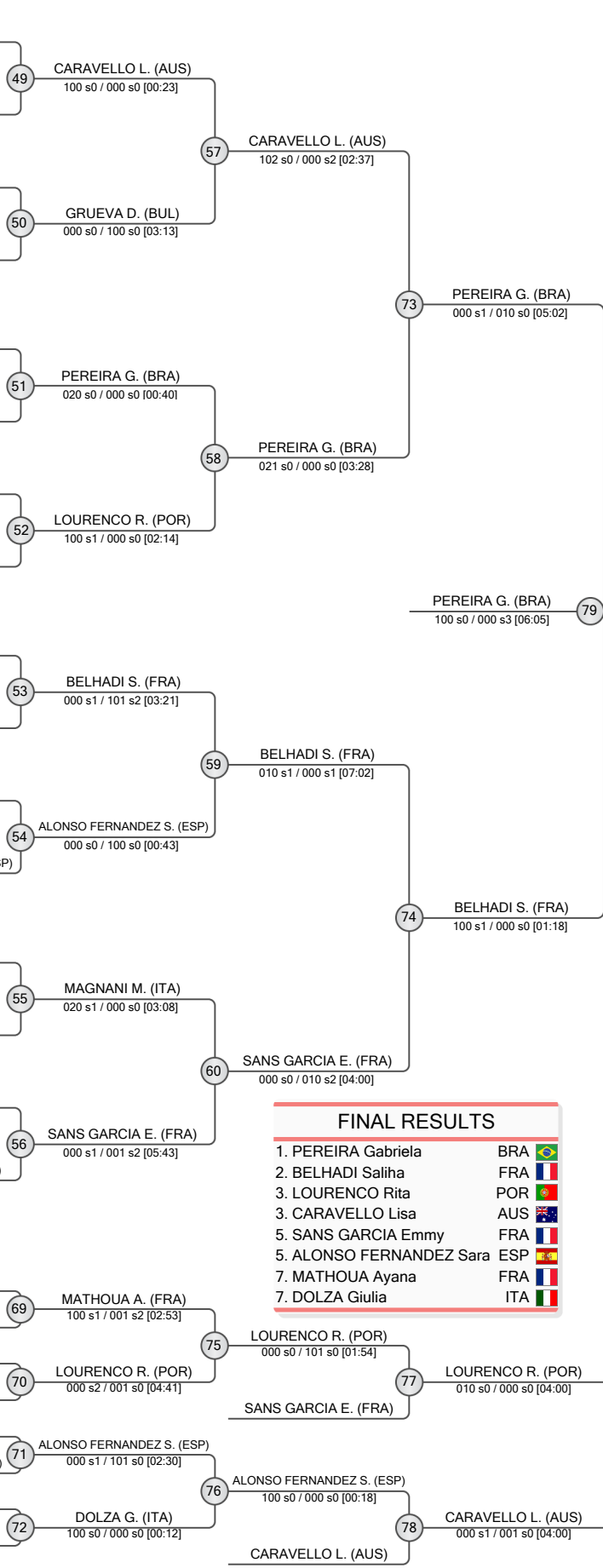

FINAL RESULTS		
1.	PEREIRA Gabriela	BRA
2.	BELHADI Saliha	FRA
3.	LOURENCO Rita	POR
3.	CARAVELLO Lisa	AUS
5.	SANS GARCIA Emmy	FRA
5.	ALONSO FERNANDEZ Sara	ESP
7.	MATHOUA Ayana	FRA
7.	DOLZA Giulia	ITA





Faro Millennium Team Cadet European Cup 2026

Portugal, Faro/Algarve, 23-24 May 2026

-63 kg

Women (35)

POOL A

1	MAIA Manuela (BRA)	2	TEIXEIRA T. (POR)	33	MAIA M. (BRA)
3	ZUPPARDI Alice (ITA)	4	AMADOR GAVINO Marina (ESP)	34	AMADOR GAVINO M. (ESP)
5	GONZALEZ ROMANILLOS Leyre (ESP)	6	BARNOIN Emmie (FRA)	35	BARNOIN E. (FRA)
7	SABINO Margarida (POR)	8	MATUSZEKOVA Petra (SVK)	36	MATUSZEKOVA P. (SVK)

POOL B

9	YILMAZ Duru (TUR)	10	MUSAZZI Asia (ITA)	37	YILMAZ D. (TUR)
11	CALDEIRA Matilde (POR)	12	BERMUDEZ DE HARO Celia (ESP)	38	BERMUDEZ DE HARO C. (ESP)
13	SPAHIC Sejla (MNE)	14	IASEVOLI Emma (ITA)	39	IASEVOLI E. (ITA)
15	ZERADIB Nesrine (FRA)	16	JOVER VALENCIA Maria (ESP)	40	JOVER VALENCIA M. (ESP)

POOL C

17	BILEN Sevim Margaret (TUR)	18	CRISOSTOMO Joana Filipa (POR)	41	CRISOSTOMO J. (POR)
19	DAFREVILLE Luane (FRA)	20	AURIN LLERINS Martina (ESP)	42	DAFREVILLE L. (FRA)
21	GONCALVES Julia (BRA)	22	ALMEIDA Ines (POR)	43	ALMEIDA I. (POR)
23	STALLONE Mariarosa (ITA)	24	CARRASCO GARCIA Claudia (ESP)	44	CARRASCO GARCIA C. (ESP)

POOL D

25	GIORDANO Valeria (ITA)	26	PLAZA SOLA Irene (ESP)	45	PLAZA SOLA I. (ESP)
27	ZAITER Nelle (FRA)	28	VASCO Ines (POR)	46	VASCO I. (POR)
29	STOEVA Andrea (BUL)	30	MIRI Yasmine (BEL)	47	MIRI Y. (BEL)
31	ROITBERG Emma (ITA)	32	GARCIA MONTES Judith Eloisa (ESP)	48	GARCIA MONTES J. (ESP)

REPECHAGE

61	TEIXEIRA T. (POR)	62	MUSAZZI A. (ITA)	63	DANISOVA E. (SVK)	64	PLAZA SOLA I. (ESP)
65	AMADOR GAVINO M. (ESP)	66	BERMUDEZ DE HARO C. (ESP)	67	BILEN S. (TUR)	68	PLAZA SOLA I. (ESP)
69	MATUSZEKOVA P. (SVK)	70	SPAHIC S. (MNE)	71	CARRASCO GARCIA C. (ESP)	72	ROITBERG E. (ITA)

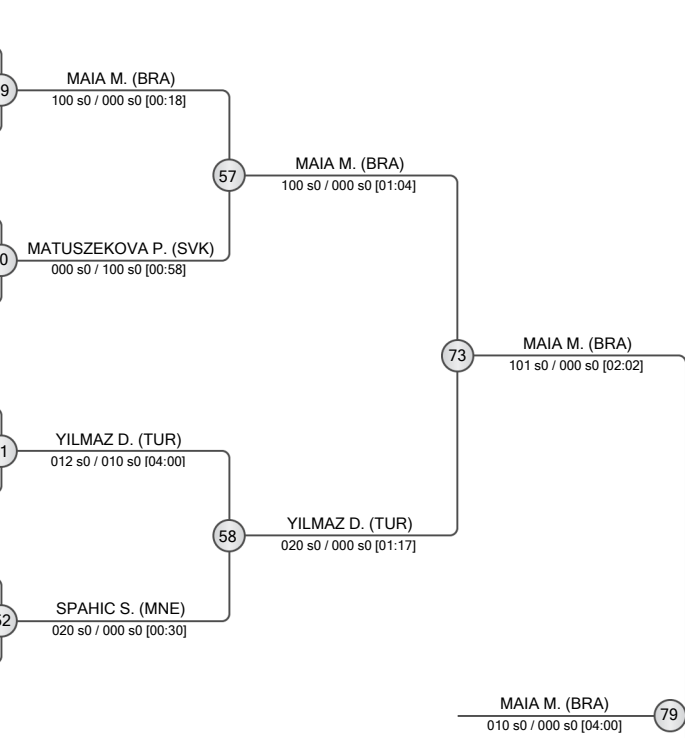

FINAL RESULTS		
1.	MAIA Manuela	BRA
2.	DAFREVILLE Luane	FRA
3.	SPAHIC Sejla	MNE
5.	GIORDANO Valeria	ITA
5.	BILEN Sevim Margaret	TUR
7.	MATUSZEKOVA Petra	SVK
7.	ROITBERG Emma	ITA





Faro Millennium Team Cadet European Cup 2026

Portugal, Faro/Algarve, 23-24 May 2026

-70 kg

Women (26)

POOL A

	TOMBOU Valerie	BEL
	FAGIANO Clara	ITA
	FERRER LOPEZ Adriana	ESP
	ILIASOVA Emilia	SVK
	WANDJI NJIOTANG Marie Emmanuelle	FRA
	MERA CARMONA Aitana	ESP
	GIL LEITAO Madalena	POR

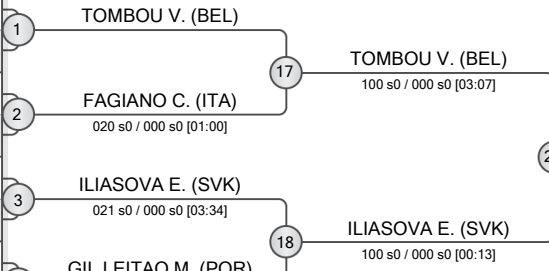

POOL B

	GUIRAL Emma	FRA
	DURA DOCON Sofia	ESP
	MEDA Ines	POR
	RESENDE Maria	BRA
	ROUX Maelys	FRA
	DEMETERCO Valentina	BRA

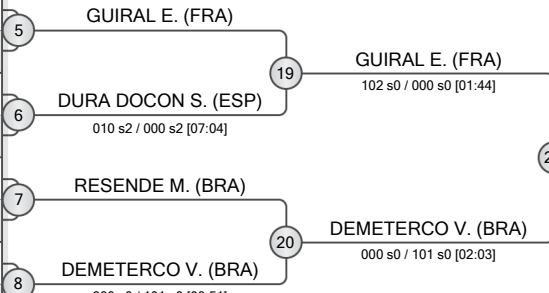

POOL C

	MOREIRA Joana	POR
	OLIVEIRA Alicia	BRA
	BAUDCHON Enora	FRA
	CAFARO Ginevra Margherita Pia	ITA
	GONZALEZ LORIENTE Martina	ESP
	LOUREIRO Maria	POR
	BENRAHAL Alya	FRA

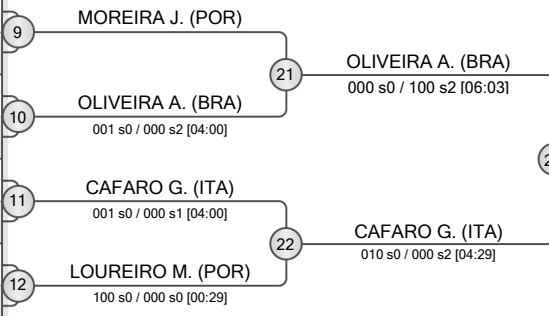

POOL D

	OZBUDAK Done Melike	TUR
	FRAILE LONGUEIRA Sara	ESP
	LE BARS Maelysse	FRA
	MBENGUE RUANO Deguene Aisha	ESP
	ZOLEZZI Noemi	ITA
	GOMES Eriea	POR

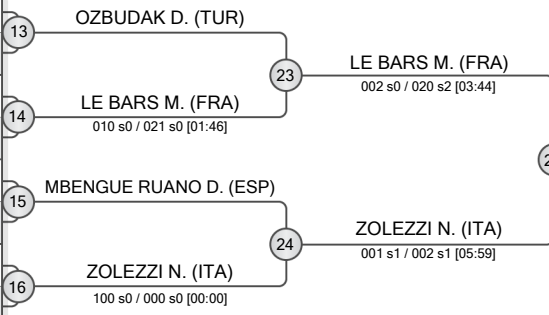

REPECHAGE

FAGIANO C. (ITA)	29	FAGIANO C. (ITA)	33	FAGIANO C. (ITA)
ROUX M. (FRA)		ILIASOVA E. (SVK)		100 s0 / 000 s0 [00:13]
RESENDE M. (BRA)	30	ROUX M. (FRA)		001 s2 / 000 s2 [08:31]
GONZALEZ LORIENTE M. (ESP)		GUIRAL E. (FRA)	34	GUIRAL E. (FRA) 000 s1 / 010 s0 [04:00]
LOUREIRO M. (POR)	31	LOUREIRO M. (POR)		000 s1 / 002 s0 [04:00]
GOMES E. (POR)		OLIVEIRA A. (BRA)	35	OLIVEIRA A. (BRA) 000 s3 / 100 s1 [06:46]
MBENGUE RUANO D. (ESP)	32	MBENGUE RUANO D. (ESP)		000 s0 / 100 s0 [00:00]
		LE BARS M. (FRA)	36	LE BARS M. (FRA) 020 s0 / 000 s0 [02:36]

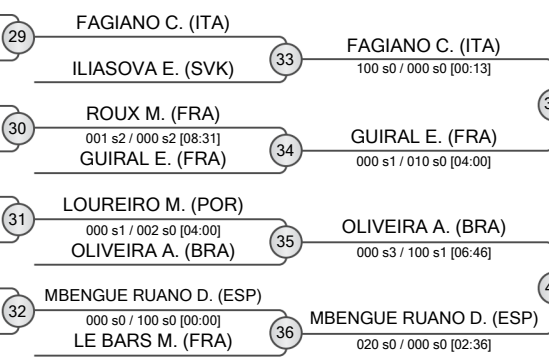

CAFARO G. (ITA) 001 s1 / 002 s0 [04:00] → 43

CAFARO G. (ITA) 002 s0 / 000 s2 [04:00] → 38

DEMETERCO V. (BRA) 000 s0 / 100 s0 [00:44] → 37

FINAL RESULTS	
1. CAFARO Ginevra Margherita Pia	ITA
2. DEMETERCO Valentina	BRA
3. FAGIANO Clara	ITA
3. TOMBOU Valerie	BEL
5. ZOLEZZI Noemi	ITA
5. OLIVEIRA Alicia	BRA
7. GUIRAL Emma	FRA
7. MBENGUE RUANO Deguene Aisha	ESP





Faro Millennium Team Cadet European Cup 2026

Portugal, Faro/Algarve, 23-24 May 2026

+ 70 kg

Women (21)

POOL A

	BALCI Hatice Tuana	TUR
	REHOUNI Amina	FRA
	CUBRILLO Tamara	SRB
	TOLEDO Yasmim	BRA
	QUINTELA MORANTE Jimena	ESP
	ALVES Matilde Lopes	POR

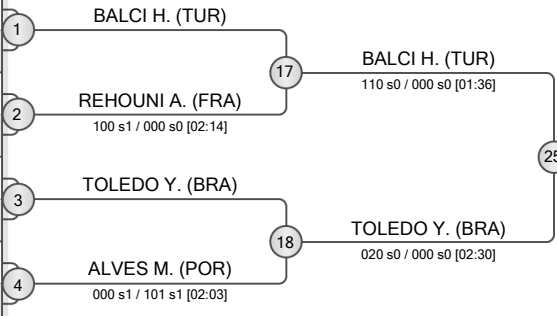

POOL B

	CHERKELIEVA Maria	BUL
	ORTIZ MURCIA Silvia	ESP
	MORGADO Mariana	POR
	MAGASSA FOFANA Sogona	ESP
	MAFRA Isabelle	BRA

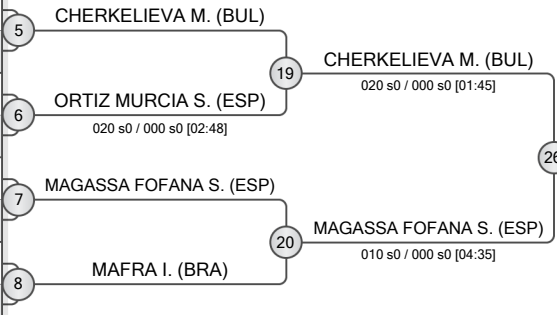

POOL C

	OHONISHI Caroline	BRA
	JANUARIO RODRIGUEZ Antia	ESP
	PAIXAO Agatha	BRA
	BARREIRA Beatriz	POR
	GNON Jennifer	FRA

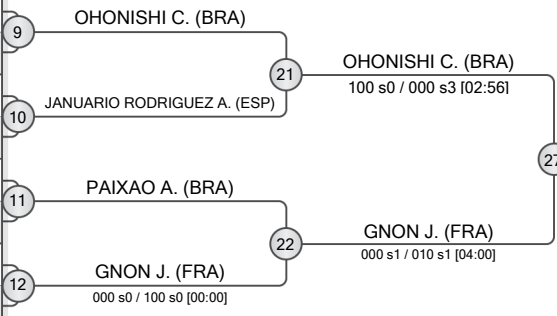

POOL D

	COULIBALY TOURE Ballalo	ESP
	VUIJSTERS Vanessa	NOR
	PALERMO Elisa	ITA
	DOUALA Perle	FRA
	MANE Iara	POR

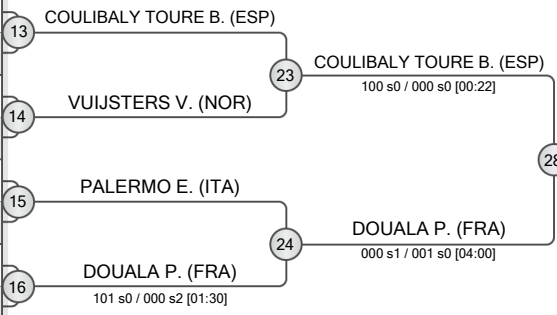

REPECHAGE

ALVES M. (POR)	29	ALVES M. (POR)	33
ORTIZ MURCIA S. (ESP)	30	ORTIZ MURCIA S. (ESP)	34
BARREIRA B. (POR)	31	PAIXAO A. (BRA)	35
PAIXAO A. (BRA)	31	OHONISHI C. (BRA)	35
VUIJSTERS V. (NOR)	32	VUIJSTERS V. (NOR)	36
VUIJSTERS V. (NOR)	32	DOUALA P. (FRA)	36

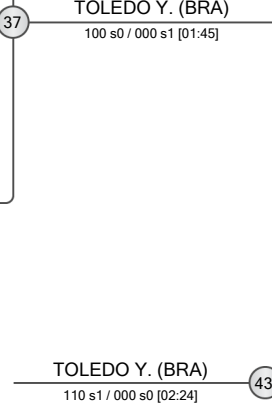
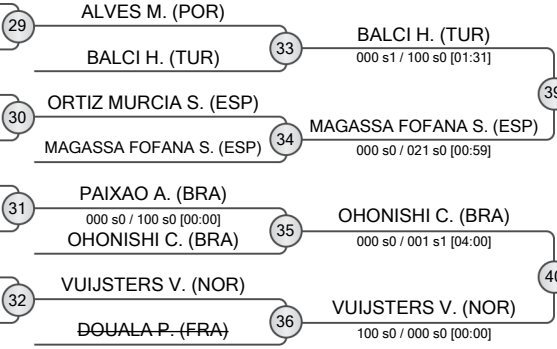

FINAL RESULTS	
1. TOLEDO Yasmim	BRA
2. COULIBALY TOURE Ballalo	ESP
3. BALCI Hatice Tuana	TUR
3. OHONISHI Caroline	BRA
5. GNON Jennifer	FRA
5. CHERKELIEVA Maria	BUL
7. MAGASSA FOFANA Sogona	ESP
7. VUIJSTERS Vanessa	NOR

