



Event Report

Tashkent Grand Slam 2024, 1-3 Mar 2024

Event Report

495 competitors from nations

255 Men

240 Women



-60 kg	-66 kg	-73 kg	-81 kg	-90 kg	-100 kg	+100 kg	Men
37	35	45	41	39	31	27	255

-48 kg	-52 kg	-57 kg	-63 kg	-70 kg	-78 kg	+78 kg	Women
35	33	31	41	35	32	33	240

Continent		Total
Nations		
Competitors		

Schedule			
Date	1 Mar	2 Mar	3 Mar
Start	09:00	09:00	09:30
Finals	17:00	17:00	17:00



Tashkent Grand Slam 2024

Uzbekistan, Tashkent, 1-3 Mar 2024

Men
Final results

-60 kg			
1	RUZIEV Doston	UZB	
2	SARDALASHVILI Giorgi	GEO	
3	YILDIZ Salih	TUR	
3	VALADIER PICARD Romain	FRA	
5	VERSTRAETEN Jorre	BEL	
5	BLIEV Ayub	AIN	
7	SMETOV Yeldos	KAZ	
7	BARATOV Dilshodbek	UZB	

-66 kg			
1	EMOMALI Nurali	TJK	
2	SHMAILOV Baruch	ISR	
3	CHOPANOV Murad	AIN	
3	LIMA Willian	BRA	
5	ABULADZE Yago	AIN	
5	NURILLAEV Sardor	UZB	
7	TANAKA Ryoma	JPN	
7	AIBEK UULU Kubanychbek	KGZ	

-73 kg			
1	LOMBARDO Manuel	ITA	
2	LAVRENTEV Danil	AIN	
3	AKHADOV Shakhram	UZB	
3	NOMANOV Obidkhon	UZB	
5	MAKHMADBEKOV Makhmadbek	AIN	
5	SHAMSHAYEV Daniyar	KAZ	
7	YULDOSHEV Murodjon	UZB	
7	STODOLSKI Adam	POL	

-81 kg			
1	CASSE Matthias	BEL	
2	BORCHASHVILI Shamil	AUT	
3	SVIDRAK Mykhailo	UKR	
3	NAGASE Takatori	JPN	
5	RAJABLI Omar	AZE	
5	ZHUBANAZAR Abylaikhan	KAZ	
7	ALBAYRAK Vedat	TUR	
7	MUKI Sagi	ISR	

-90 kg			
1	TSELIDIS Theodoros	GRE	
2	IVANOV Ivaylo	BUL	
3	PARLATI Christian	ITA	
3	BOBONOV Davlat	UZB	
5	IGOLNIKOV Mikhail	AIN	
5	SILVA MORALES Ivan Felipe	CUB	
7	FLORENTINO Robert	DOM	
7	CRET Alex	ROU	

-100 kg			
1	TUROBOYEV Muzaffarbek	UZB	
2	KANIKOVSKIY Matvey	AIN	
3	ARAI Dota	JPN	
3	KUCZERA Piotr	POL	
5	NIKIFOROV Toma	BEL	
5	ADAMIAN Arman	AIN	
7	JANDREEV Shermukhammad	UZB	
7	SHORAKHMATOV Rustam	UZB	

+100 kg			
1	OTA Hyoga	JPN	
2	BASHAEV Tamerlan	AIN	
3	KAGEURA Kokoro	JPN	
3	TASOEV Inal	AIN	
5	SIPOCZ Richard	HUN	
5	BAKHTIYOROV Shokhrukhkhon	UZB	
7	TUROBOYEV Utkirbek	UZB	
7	YUSUPOV Alisher	UZB	



Tashkent Grand Slam 2024

Uzbekistan, Tashkent, 1-3 Mar 2024

Women Final results

-48 kg		
1	GILIAZOVA Sabina	AIN
2	ABUZHAKYNOVA Abiba	KAZ
3	BABULFATH Tara	SWE
3	BEDER Tugce	TUR
5	RISHONY Shira	ISR
5	BAVUUDORJ Baasankhuu	MGL
7	FIGUEROA Julia	ESP
7	LABORDE Maria Celia	USA

-52 kg		
1	BUCHARD Amandine	FRA
2	JURAEVA Gulkhayo	UZB
3	LKHAGVASUREN Sosorbaram	MGL
3	GILES Chelsie	GBR
5	FUJISHIRO Kokoro	JPN
5	BISHRELT Khorloodoi	UAE
7	GNETO Astride	FRA
7	ASVESTA Sofia	CYP

-57 kg		
1	GNETO Priscilla	FRA
2	FUNAKUBO Haruka	JPN
3	STARKE Pauline	GER
3	PODOLAK Arleta	POL
5	PARDAYEVA Maysa	TKM
5	BALLHAUS Seija	GER
7	KAJZER Kaja	SLO
7	KURBONMAMADOVA Daria	AIN

-63 kg		
1	AGBEGNEOU Clarisse	FRA
2	TATSUKAWA Momo	JPN
3	NABEKURA Nami	JPN
3	LESKI Andreja	SLO
5	POHL Dena	GER
5	SHARIR Gili	ISR
7	SHEMESH Inbal	ISR
7	OBERAN Iva	CRO

-70 kg		
1	BUTKEREIT Miriam	GER
2	PINOT Margaux	FRA
3	NIIZOE Saki	JPN
3	DE VOOGD Margit	NED
5	GERCSAK Szabina	HUN
5	MATNIYAZOVA Gulnoza	UZB
7	TAIMAZOVA Madina	AIN
7	PETERSEN POLLARD Kelly	GBR

-78 kg		
1	TAKAYAMA Rika	JPN
2	POSVITE Fanny Estelle	FRA
3	WAGNER Anna-Maria	GER
3	BELLANDI Alice	ITA
5	BOEHM Alina	GER
5	SAMPAIO Patricia	POR
7	LANIR Inbar	ISR
7	MA Zhenzhao	CHN

+78 kg		
1	SU Xin	CHN
2	TAKAHASHI Ruri	JPN
3	SEGAWA Maya	JPN
3	STARTSEVA Elis	AIN
5	OZTURK Hilal	TUR
5	FONTAINE Lea	FRA
7	NUNES Rochele	POR
7	BOUIZGARNE Samira	GER



Medals

Tashkent Grand Slam 2024, 1-3 Mar 2024

Medals

Nations: 23

#	Nation		1. Place	2. Place	3. Place	4. Place	5. Place	7. Place
		FRA France	3	2	1		1	1
		JPN Japan	2	3	6		1	1
		UZB Uzbekistan	2	1	3		3	6
		GER Germany	1		2		3	1
		ITA Italy	1		2			
		BEL Belgium	1				2	
		CHN People's Republic of China	1					1
		GRE Greece	1					
		TJK Tajikistan	1					
		ISR Israel		1			2	3
		KAZ Kazakhstan		1			2	1
		AUT Austria		1				
		BUL Bulgaria		1				
		GEO Georgia		1				
		TUR Türkiye			2		1	1
		POL Poland			2			1
		MGL Mongolia			1		1	
		GBR Great Britain			1			1
		SLO Slovenia			1			1
		BRA Brazil			1			
		NED Netherlands			1			
		SWE Sweden			1			
		UKR Ukraine			1			
		HUN Hungary					2	
		POR Portugal					1	1
		AZE Azerbaijan					1	
		CUB Cuba					1	
		TKM Turkmenistan					1	
		UAE United Arab Emirates					1	
		CRO Croatia						1
		CYP Cyprus						1
		DOM Dominican Republic						1
		KGZ Kyrgyzstan						1
		ROU Romania						1
		ESP Spain						1
		USA United States of America						1

Official person:



Statistics

Tashkent Grand Slam 2024, 1-3 Mar 2024

Statistics

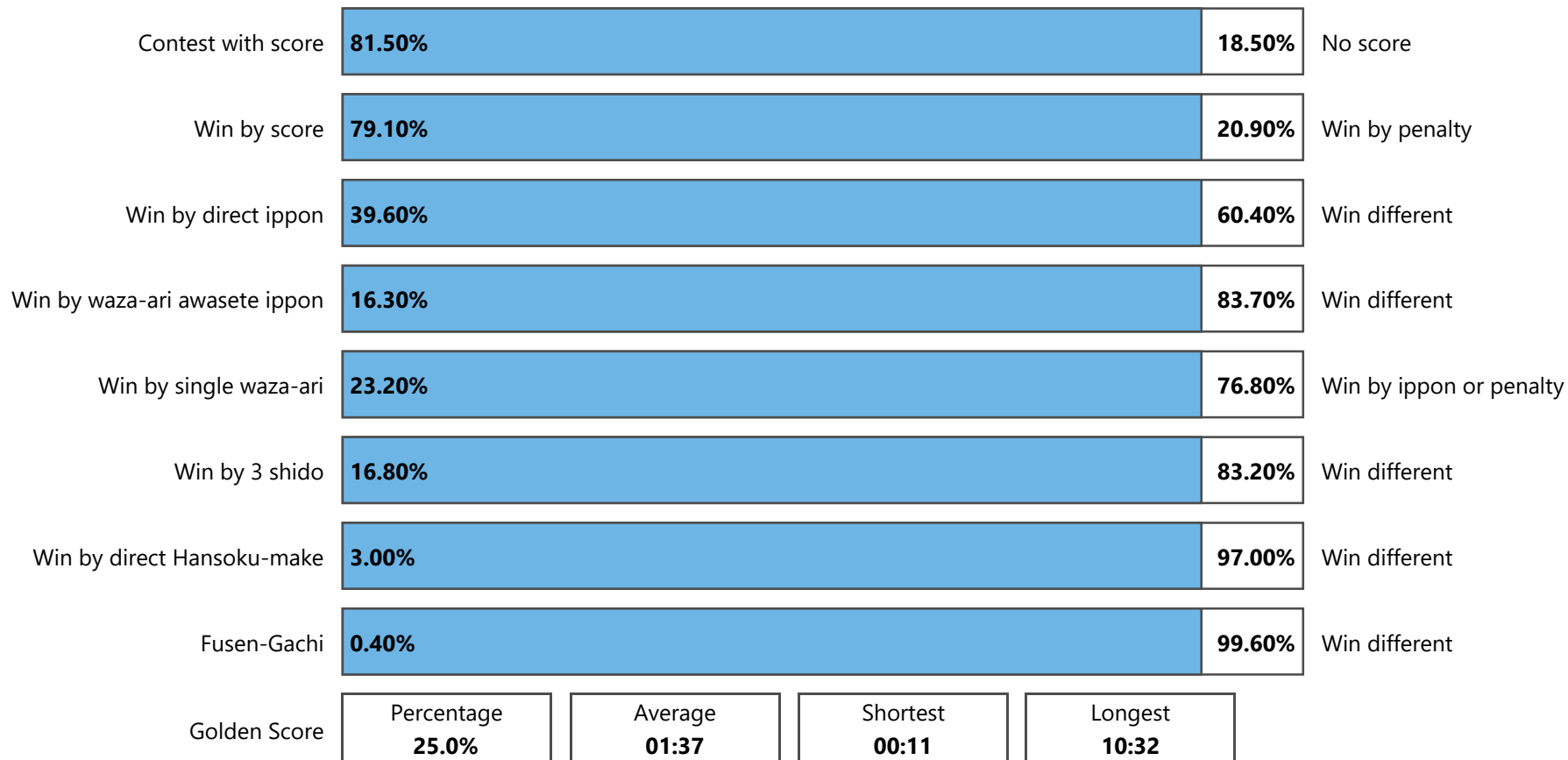



Statistics

Tashkent Grand Slam 2024, 1-3 Mar 2024

Statistics

	-60	-66	-73	-81	-90	-100	+100	M	-48	-52	-57	-63	-70	-78	+78	W	Total
Competitors	37	35	45	41	39	31	27	255	35	33	31	41	35	32	33	240	495
Contests	40	38	48	44	42	34	30	276	36	36	34	44	38	35	36	259	535
Contests with score	34	29	36	33	34	27	28	221	32	31	31	39	27	31	24	215	436
Contests with score %	85%	76.3%	75%	75%	81%	79.4%	93.3%	80.1%	88.9%	86.1%	91.2%	88.6%	71.1%	88.6%	66.7%	83.0%	81.5%
Wins by Score	34	27	35	32	33	27	27	215	32	30	30	36	27	30	23	208	423
Wins by Score %	85%	71.1%	72.9%	72.7%	78.6%	79.4%	90%	77.9%	88.9%	83.3%	88.2%	81.8%	71.1%	85.7%	63.9%	80.3%	79.1%
Wins by direct Ippon	15	12	20	19	17	10	14	107	16	13	14	17	15	17	13	105	212
Wins by direct Ippon %	37.5%	31.6%	41.7%	43.2%	40.5%	29.4%	46.7%	38.8%	44.4%	36.1%	41.2%	38.6%	39.5%	48.6%	36.1%	40.5%	39.6%
Wins by Waza-ari Awasete Ippon	9	2	4	5	6	8	8	42	4	7	7	9	6	5	7	45	87
Wins by Waza-ari Awasete Ippon %	22.5%	5.3%	8.3%	11.4%	14.3%	23.5%	26.7%	15.2%	11.1%	19.4%	20.6%	20.5%	15.8%	14.3%	19.4%	17.4%	16.3%
Wins by single Waza-ari	10	13	11	8	10	9	5	66	12	10	9	10	6	8	3	58	124
Wins by single Waza-ari %	25%	34.2%	22.9%	18.2%	23.8%	26.5%	16.7%	23.9%	33.3%	27.8%	26.5%	22.7%	15.8%	22.9%	8.3%	22.4%	23.2%
Wins by 3 Shido for opponent	3	7	9	10	6	7	3	45	3	6	3	7	11	4	11	45	90
Wins by 3 Shido for opponent %	7.5%	18.4%	18.8%	22.7%	14.3%	20.6%	10%	16.3%	8.3%	16.7%	8.8%	15.9%	28.9%	11.4%	30.6%	17.4%	16.8%
Direct Hansoku-make	2	3	3	2	3			13	1		1			1		3	16
Wins by direct Hansoku-make %	5%	7.9%	6.3%	4.5%	7.1%	0%	0%	4.7%	2.8%	0%	2.9%	0%	0%	2.9%	0%	1.2%	3.0%
Fusen-gachi			1					1							1	1	2
Fusen-gachi %	0%	0%	2.1%	0%	0%	0%	0%	0.4%	0%	0%	0%	0%	0%	0%	2.8%	0.4%	0.4%
All positive Scores (Waza-ari + direct Ippon)	49	34	48	44	47	41	40	303	39	42	41	53	38	42	34	289	592
Average Scores per contests	1.2	0.9	1	1	1.1	1.2	1.3	1.1	1.1	1.2	1.2	1.2	1	1.2	0.9	1.11	1.11
All penalties (Shido + HSK)	79	105	89	113	82	74	62	604	54	75	60	88	78	65	70	490	1094
Average penalty per contest	2	2.8	1.9	2.6	2	2.2	2.1	2.23	1.5	2.1	1.8	2	2.1	1.9	1.9	1.9	2.06
Golden Score	10	13	14	20	7	8	4	76	8	9	8	13	10	6	4	58	134
Golden Score %	25%	34.2%	29.2%	45.5%	16.7%	23.5%	13.3%	27.5%	22.2%	25%	23.5%	29.5%	26.3%	17.1%	11.1%	22.4%	25.0%
Osae-komi																	
Osae-komi %	0%	0%	0%	0%	0%	0%	0%	0%	0%	0%	0%	0%	0%	0%	0%	0%	0%
Wins by Penalty	5	10	12	12	9	7	3	58	4	6	4	7	11	5	11	48	106



Nations Overview

Tashkent Grand Slam 2024, 1-3 Mar 2024

Nations

Overview

			-60	-66	-73	-81	-90	-100	+100	M	-48	-52	-57	-63	-70	-78	+78	W	Total	D	
1.		AIN	Individual Neutral Athletes	2	2	3	2	4	3	2	18	2	3	2	3	2	2	2	16	34	10
2.		ARG	Argentina	0	0	1	0	0	0	0	1	0	0	0	0	0	0	0	0	1	0
3.		AUT	Austria	0	0	0	1	1	0	0	2	0	0	0	0	0	0	0	0	2	2
4.		AZE	Azerbaijan	2	2	2	1	0	0	0	7	1	2	1	1	0	0	0	5	12	8
5.		BEL	Belgium	1	0	0	1	1	1	0	4	0	0	1	0	0	0	0	1	5	3
6.		BRA	Brazil	0	1	0	0	2	2	0	5	1	0	1	2	2	0	1	7	12	6
7.		BUL	Bulgaria	0	0	1	1	1	1	0	4	0	1	1	0	0	0	0	2	6	3
8.		CAF	Central African Republic	0	0	0	0	0	0	0	0	0	0	0	1	0	0	0	1	1	0
9.		CHI	Chile	0	0	0	0	0	0	0	0	1	0	0	0	0	0	0	1	1	0
10.		CHN	People's Republic of China	0	0	0	0	0	0	0	0	2	1	1	1	1	1	2	9	9	8
11.		COL	Colombia	1	1	0	0	0	0	0	2	0	0	0	0	0	0	0	0	2	0
12.		CRO	Croatia	0	0	0	0	0	0	0	0	0	1	0	2	0	2	2	7	7	4
13.		CUB	Cuba	1	1	1	0	1	0	1	5	0	0	0	1	1	0	1	3	8	4
14.		CYP	Cyprus	0	0	0	0	0	1	1	2	0	1	0	0	0	1	0	2	4	1
15.		CZE	Czechia	0	0	0	1	1	0	0	2	0	0	0	0	0	0	0	0	2	1
16.		DOM	Dominican Republic	0	0	0	1	1	0	0	2	0	0	0	0	0	1	1	2	4	2
17.		EGY	Egypt	1	1	0	1	0	0	0	3	0	0	0	0	0	0	0	0	3	2
18.		ESP	Spain	0	0	1	1	0	0	0	2	1	0	0	2	0	0	0	3	5	5
19.		EST	Estonia	0	2	0	0	1	0	0	3	0	0	0	0	0	0	0	0	3	1
20.		FRA	France	1	1	1	1	0	0	1	5	0	2	1	1	1	2	1	8	13	8
21.		GBR	Great Britain	0	0	0	0	0	0	0	0	0	1	1	1	2	1	0	6	6	3
22.		GEO	Georgia	2	1	1	0	0	2	0	6	0	0	0	0	0	0	0	0	6	4
23.		GER	Germany	0	1	2	1	1	1	1	7	1	2	2	2	2	2	2	13	20	7
24.		GRE	Greece	0	0	0	0	1	0	0	1	0	0	0	0	0	0	0	0	1	1
25.		GUA	Guatemala	1	0	0	0	0	0	0	1	1	0	0	0	0	0	0	1	2	1
26.		HUN	Hungary	0	0	0	1	2	0	1	4	0	0	0	0	1	0	0	1	5	5
27.		IND	India	1	1	0	0	1	2	1	6	1	1	1	2	2	0	1	8	14	1
28.		IRT	IJF Refugee Team	0	0	1	1	0	0	0	2	0	0	0	0	0	0	0	0	2	1
29.		ISR	Israel	0	2	1	1	0	1	0	5	2	0	1	2	1	1	1	8	13	8
30.		ITA	Italy	2	1	2	1	1	2	1	10	1	2	0	2	1	2	1	9	19	9
31.		JAM	Jamaica	0	0	0	1	0	0	0	1	0	0	0	0	0	0	0	0	1	0
32.		JPN	Japan	1	1	0	1	0	1	2	6	0	1	1	2	1	1	2	8	14	15
33.		KAZ	Kazakhstan	2	2	2	2	2	2	2	14	2	2	1	2	1	2	2	12	26	23
34.		KGZ	Kyrgyzstan	0	2	2	2	2	0	1	9	0	0	1	2	1	1	0	5	14	3
35.		KSA	Saudi Arabia	1	1	2	2	0	0	1	7	0	0	0	0	0	0	1	1	8	2
36.		KUW	Kuwait	1	0	0	0	0	0	0	1	0	0	0	0	0	0	0	0	1	0
37.		LBN	Lebanon	0	0	0	0	1	0	0	1	0	0	0	0	1	0	0	1	2	1
38.		LTU	Lithuania	0	0	1	0	0	0	0	1	0	0	0	0	1	1	0	2	3	0
39.		MAR	Morocco	1	1	1	1	0	0	0	4	0	1	0	0	1	0	0	2	6	3
40.		MDA	Republic of Moldova	0	0	1	2	0	0	0	3	0	0	0	0	0	0	0	0	3	1
41.		MEX	Mexico	1	0	0	0	0	0	0	1	1	1	0	1	0	0	0	3	4	4
42.		MGL	Mongolia	2	0	1	1	1	0	0	5	2	1	0	1	2	2	1	9	14	4
43.		MON	Monaco	0	0	0	0	0	0	1	1	0	0	0	0	0	0	0	0	1	1
44.		NCA	Nicaragua	0	0	0	0	0	0	0	0	0	0	0	0	0	0	1	1	1	1
45.		NED	Netherlands	0	0	0	0	0	0	0	0	0	0	0	0	1	1	1	3	3	1
46.		PHI	Philippines	0	1	1	0	0	0	0	2	0	0	0	1	0	0	0	1	3	1



Nations Overview

Tashkent Grand Slam 2024, 1-3 Mar 2024

Nations

Overview

			-60	-66	-73	-81	-90	-100	+100	M	-48	-52	-57	-63	-70	-78	+78	W	Total	D	
47.		POL	Poland	0	0	2	0	0	1	1	4	0	1	2	0	1	1	6	10	6	
48.		POR	Portugal	1	0	0	1	0	1	0	3	0	1	0	1	1	1	5	8	4	
49.		PRK	Democratic People's Republic of Korea	1	0	1	0	0	0	0	2	1	0	0	0	1	0	2	4	4	
50.		ROU	Romania	0	0	1	1	2	0	0	4	0	0	0	1	0	0	1	5	4	
51.		RSA	South Africa	0	0	0	0	0	0	0	0	0	1	0	0	0	0	1	1	0	
52.		SEN	Senegal	0	0	0	0	1	0	1	2	0	0	0	0	0	0	0	2	1	
53.		SLO	Slovenia	0	0	1	0	0	0	0	1	1	0	1	1	0	0	3	4	2	
54.		SRB	Serbia	0	0	0	0	0	0	0	0	1	0	0	0	0	1	2	2	2	
55.		SRI	Sri Lanka	0	0	1	0	0	0	0	1	0	0	0	0	0	0	0	1	1	
56.		SUI	Switzerland	0	0	0	0	0	1	0	1	0	1	0	0	0	0	1	2	1	
57.		SWE	Sweden	0	0	0	0	1	0	0	1	1	0	0	0	1	0	2	3	3	
58.		THA	Thailand	0	0	1	0	0	0	0	1	0	0	0	0	1	0	1	2	0	
59.		TJK	Tajikistan	2	1	1	2	2	1	1	10	1	1	1	1	0	0	4	14	5	
60.		TKM	Turkmenistan	2	2	2	1	1	1	0	9	2	1	2	1	0	1	7	16	9	
61.		TPE	Chinese Taipei	1	1	0	0	0	0	0	2	2	1	0	0	1	1	5	7	6	
62.		TUR	Türkiye	1	0	1	1	0	0	2	5	2	0	2	0	0	2	6	11	4	
63.		UAE	United Arab Emirates	0	1	1	1	1	1	0	5	0	1	1	0	0	0	2	7	3	
64.		UKR	Ukraine	1	0	0	1	0	1	1	4	0	0	0	0	0	0	0	4	1	
65.		URU	Uruguay	0	0	0	1	0	0	0	1	0	0	0	0	0	0	0	1	0	
66.		USA	United States of America	0	0	1	0	2	1	1	5	1	0	1	0	0	0	2	7	3	
67.		UZB	Uzbekistan	4	4	4	4	4	4	4	28	4	3	4	4	4	4	27	55	17	
68.		VEN	Venezuela	0	1	0	0	0	0	0	1	0	0	0	0	1	0	2	3	1	
				37	35	45	41	39	31	27	255	35	33	31	41	35	32	33	240	495	245



Tashkent Grand Slam 2024

Uzbekistan, Tashkent, 1-3 Mar 2024

-60 kg

Men (37)

POOL A

1	SARDALASHVILI Giorgi (GEO)	33	SARDALASHVILI G. (GEO)
2	BAKHTIYOROV Kamoliddin (UZB)		01 s1 / 00 s1 [04:00]
3	GULOV H. (TJK)	34	GULOV H. (TJK)
4	GULOV Haqdod (TJK)		00 s0 / 01 s1 [05:55]
5	HASAN Habib (KUW)		11 s0 / 01 s0 [03:31]
6	CHKHMIMIANI Lukhumi (GEO)	35	CHKHMIMIANI L. (GEO)
7	LOPES Rodrigo Costa (POR)		01 s2 / 00 s2 [05:21]
8	SMETOV Yeldos (KAZ)	36	SMETOV Y. (KAZ)
	CHARON Jonathan (CUB)		11 s1 / 00 s0 [02:47]

POOL B

9	VALADIER PICARD Romain (FRA)	37	VALADIER PICARD R. (FRA)
10	ALIYEV Rovshan (AZE)		10 s1 / 00 s1 [01:45]
11	JUAREZ Arath (MEX)	38	CHAE K. (PRK)
12	CHAE Kwang jin (PRK)		00 s1 / 02 s0 [02:29]
13	OMIROV Aybek (TKM)		10 s1 / 00 H [02:50]
14	VERSTRAETEN Jorre (BEL)	39	VERSTRAETEN J. (BEL)
15	BOTUROV Bakhrom (UZB)		10 s0 / 00 s0 [05:17]
16	ENKHTAIVAN Sumiyabazar (MGL)	40	ZAIRBEKOV G. (AIN)
17	KONDO Hayato (JPN)		00 s2 / 02 s1 [03:36]
18	ZAIRBEKOV Gamzat (AIN)		00 s0 / 02 s0 [03:35]

POOL C

17	BARATOV Dilshodbek (UZB)	41	BARATOV D. (UZB)
18	SADDIKI Younes (MAR)		10 s2 / 00 s3 [04:13]
19	RAMOS Jose (GUA)	42	RAMOS J. (GUA)
20	RAMAZANOV Mekan (TKM)		02 s0 / 00 s0 [03:38]
21	YILDIZ Salih (TUR)	43	YILDIZ S. (TUR)
22	FALATAH Mohammed (KSA)		02 s0 / 00 s2 [03:05]
23	PANTANO Angelo (ITA)	44	PANTANO A. (ITA)
24	ROJAS Johan (COL)		01 s2 / 00 s2 [05:13]
25	TALIBOV Nazir (AZE)		01 s0 / 00 s2 [04:00]

POOL D

25	ENKHTAIVAN Ariunbold (MGL)	45	ENKHTAIVAN A. (MGL)
26	LIN Chong-You (TPE)		02 s1 / 00 s0 [01:47]
27	RUZIEV Doston (UZB)	46	RUZIEV D. (UZB)
28	YADAV Vijay Kumar (IND)		10 s0 / 00 s1 [02:13]
29	SERIKBAYEV Nurkanat (KAZ)	47	SERIKBAYEV N. (KAZ)
30	SUFIEV Mehrzod (TJK)		02 s1 / 00 s1 [03:20]
31	SAMY Youssry (EGY)	48	BLIEV A. (AIN)
32	VISKOV Nazar (UKR)		00 s3 / 10 s1 [07:53]
33	BLIEV Ayub (AIN)		00 s0 / 11 s0 [01:25]

REPECHAGE

61	VERSTRAETEN J. (BEL)	65	YILDIZ S. (TUR)
	00 s0 / 00 s0 [00:00]		00 s3 / 10 s1 [03:47]
	VERSTRAETEN J. (BEL)		YILDIZ S. (TUR)
62	BLIEV A. (AIN)	66	VALADIER PICARD R. (FRA)
	00 s0 / 10 s2 [02:18]		00 s0 / 10 s0 [04:11]
	BLIEV A. (AIN)		VALADIER PICARD R. (FRA)

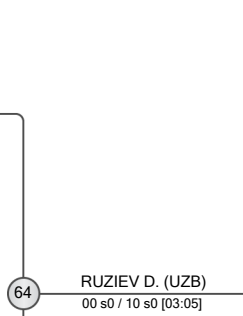
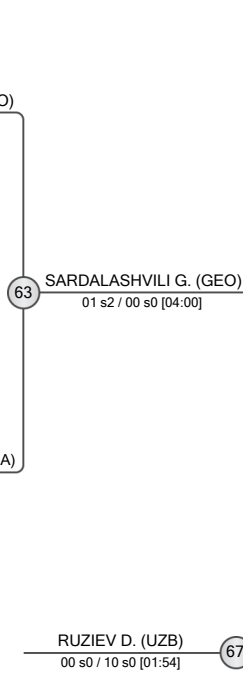

FINAL RESULTS

- RUZIEV Doston (UZB)
- SARDALASHVILI Giorgi (GEO)
- YILDIZ Salih (TUR)
- VALADIER PICARD Romain (FRA)
- VERSTRAETEN Jorre (BEL)
- BLIEV Ayub (AIN)
- SMETOV Yeldos (KAZ)
- BARATOV Dilshodbek (UZB)





Tashkent Grand Slam 2024

Uzbekistan, Tashkent, 1-3 Mar 2024

-66 kg

Men (35)

POOL A

1	LIMA Willian (BRA)	33	LIMA W. (BRA)
2	HERNANDEZ Juan (COL)	34	BOUSHITA A. (MAR)
3	CHYNYBEKOV Kazybek (KGZ)	35	VADJIEV B. (UZB)
4	AGAMAMMEDOV Hekim (TKM)	36	CHOPANOV M. (AIN)
5	PIRAS Matteo (ITA)	37	BOUDA R. (FRA)
6	VADJIEV Bobur (UZB)	38	CHOPANOV M. (AIN)
7	CHOPANOV Murad (AIN)	39	TANAKA R. (JPN)
8	BOUDA Romaric Wend-Yam (FRA)	40	NUTFULLOEV A. (UZB)

POOL B

9	BAYANMUNKH Narmandakh (UAE)	37	RAKHMETKALI Z. (KAZ)
10	RAKHMETKALI Zhanarys (KAZ)	38	SHMAILOV B. (ISR)
11	CHENG Yen-Ming (TPE)	39	YELKIYEV R. (AZE)
12	SHMAILOV Baruch (ISR)	40	NUTFULLOEV A. (UZB)
13	NADIRADZE Lasha (GEO)	41	TILOVOV M. (UZB)
14	TANAKA Ryoma (JPN)	42	ABULADZE Y. (AIN)
15	YELKIYEV Rashad (AZE)	43	ABDELMAWGOUD M. (EGY)
16	LIPARD Viljar (EST)	44	RAHIMOV I. (AZE)
17	NUTFULLOEV Abdurakhim (UZB)	45	HAWSAWI M. (KSA)

POOL C

18	TILOVOV Mukhridin (UZB)	41	FLICKER T. (ISR)
19	FLICKER Tal (ISR)	42	ABULADZE Y. (AIN)
20	NAKANO Shugen (PHI)	43	ABDELMAWGOUD M. (EGY)
21	POLANCO Orlando (CUB)	44	RAHIMOV I. (AZE)
22	ABULADZE Yago (AIN)	45	HAWSAWI M. (KSA)
23	NURILLAEV Sardor (UZB)	46	AIBEK UULU K. (KGZ)
24	ABDELMAWGOUD Mohamed (EGY)	47	EMOMALI N. (TJK)
25	RAHIMOV Serdar (TKM)	48	CHAUHAN N. (IND)
26	RAHIMOV Islam (AZE)	49	LIMA W. (BRA)

POOL D

27	KYRGYZBAYEV Gusman (KAZ)	45	HAWSAWI M. (KSA)
28	HAWSAWI Mounis (KSA)	46	AIBEK UULU K. (KGZ)
29	PERTELSON Oscar (EST)	47	EMOMALI N. (TJK)
30	AIBEK UULU Kubanychbek (KGZ)	48	CHAUHAN N. (IND)
31	EMOMALI Nurali (TJK)	49	LIMA W. (BRA)
32	SETZ Martin (GER)	50	CHOPANOV M. (AIN)
33	GARCIA Willis (VEN)	51	SHMAILOV B. (ISR)
34	CHAUHAN Nitin (IND)	52	TANAKA R. (JPN)

REPECHAGE

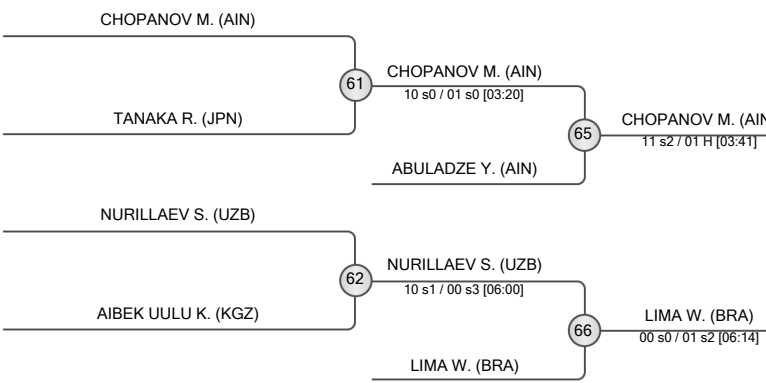

FINAL RESULTS

- EMOMALI Nurali (TJK)
- SHMAILOV Baruch (ISR)
- CHOPANOV Murad (AIN)
- LIMA Willian (BRA)
- ABULADZE Yago (AIN)
- NURILLAEV Sardor (UZB)
- TANAKA Ryoma (JPN)
- AIBEK UULU Kubanychbek (KGZ)





Tashkent Grand Slam 2024

Uzbekistan, Tashkent, 1-3 Mar 2024

-73 kg

Men (45)

POOL A

1	YULDOSHEV Murodjon	UZB	1	YULDOSHEV M. (UZB)	33	YULDOSHEV M. (UZB)
2	YONEZUKA Jack	USA	2	YONEZUKA J. (USA)	02 s0 / 00 s0 [03:49]	
3	MIRZAYEV Nariman	AZE	3	BATZAYA E. (MGL)	10 s0 / 00 s0 [01:20]	
4	BATZAYA Erdenebayar	MGL	4	GOBERT M. (FRA)	10 s0 / 00 s3 [01:45]	
5	NAKANO Keisei	PHI	5	GOBERT M. (FRA)	01 s1 / 00 s2 [04:00]	
6	GOBERT Maxime	FRA	6	LAVRENTEV D. (AIN)	10 s0 / 00 s0 [00:55]	
7	BUTBUL Tohar	ISR	7	MELLA E. (ITA)	01 s0 / 00 s1 [04:00]	
8	LAVRENTEV Danil	AIN	8	NAJMUDINOV M. (TJK)	00 s0 / 11 s1 [02:05]	
9	SHAMURADOV Meylis	TKM				
10	MELLA Edoardo	ITA				
11	MORKA Ksawery	POL				
12	NAJMUDINOV Mahamadsharif	TJK				

POOL B

9	MAKHMADBEKOV Makhmadbek	AIN	9	MAKHMADBEKOV M. (AIN)	37	MAKHMADBEKOV M. (AIN)
10	NINIASHVILI Bagrati	GEO	10	NINIASHVILI B. (GEO)	10 s0 / 00 s0 [02:06]	
11	JUMAEV Mukhammad	UZB	11	JUMAEV M. (UZB)	10 s0 / 00 s1 [01:12]	
12	MAJIDI Kavan	IRT	12	KIM C. (PRK)	00 s2 / 02 s1 [03:22]	
13	KIM Chol Gwang	PRK	13	SHAMSHAYEV D. (KAZ)	10 s2 / 00 s1 [01:11]	
14	SHAMSHAYEV Daniyar	KAZ	14	SAGYNALIEV C. (KGZ)	00 s1 / 01 s0 [04:00]	
15	HAMAD Sulaiman	KSA	15	GABLER A. (GER)	00 s0 / 11 s1 [02:23]	
16	SAGYNALIEV Chyngyzkhan	KGZ	16	HOJAK M. (SLO)	00 H / 11 s0 [02:22]	
17	ADARVEZ Karim	ARG				
18	GABLER Alexander Bernd	GER				
19	HOJAK Martin	SLO				

POOL C

17	LOMBARDO Manuel	ITA	17	LOMBARDO M. (ITA)	41	LOMBARDO M. (ITA)
18	ABDISALAMOV Amal	TKM	18	TERADA M. (THA)	01 s0 / 10 s0 [03:15]	
19	TERADA Masayuki	THA	19	ALIYEV I. (AZE)	00 s2 / 01 s1 [04:22]	
20	RAICU Alexandru	ROU	20	DEMIREL U. (TUR)	10 s0 / 00 s0 [00:33]	
21	ALIYEV Ibrahim	AZE	21	ESTRADA M. (CUB)	10 s0 / 00 s1 [02:51]	
22	DEMIREL Umalt	TUR	22	VITKAUSKAS K. (LTU)	10 s0 / 00 s3 [05:23]	
23	ESTRADA Magdiel	CUB	23	STODOLSKI A. (POL)	10 s2 / 00 s2 [04:38]	
24	VITKAUSKAS Kestutis	LTU	24	NARKULOV A. (KAZ)		
25	REPIYALLAGE Chamara	SRI				
26	STODOLSKI Adam	POL				
27	NARKULOV Askar	KAZ				

POOL D

25	AKHADOV Shakhram	UZB	25	AKHADOV S. (UZB)	45	AKHADOV S. (UZB)
26	HRISTOV Mark	BUL	26	HRISTOV M. (BUL)	10 s1 / 00 s3 [05:21]	
27	DOUKKALI Hassan	MAR	27	DOUKKALI H. (MAR)	02 s0 / 00 s0 [03:24]	
28	HAMMAD Abdullah	KSA	28	OSMANOV A. (MDA)	00 s0 / 01 s0 [04:00]	
29	OSMANOV Adil	MDA	29	NOMANOV O. (UZB)	11 s0 / 00 s0 [03:38]	
30	NOMANOV Obidkhon	UZB	30	ABDULAEV K. (UAE)	10 s1 / 00 H [01:47]	
31	ABDULAEV Karim	UAE	31	HALAVACHOU R. (AIN)	10 s1 / 00 s2 [02:34]	
32	CANO GARCIA Jorge	ESP	32	WANDTKE I. (GER)	00 s1 / 10 s1 [05:26]	
33	HALAVACHOU Ruslan	AIN				
34	BAKYTBEK UULU Adam	KGZ				
35	WANDTKE Igor	GER				

REPECHAGE

61	MAKHMADBEKOV M. (AIN)	00 s1 / 01 s2 [04:18]	65	AKHADOV S. (UZB)	00 s3 / 10 s0 [05:09]
62	NOMANOV O. (UZB)	00 s1 / 01 s1 [04:00]	66	NOMANOV O. (UZB)	10 s0 / 00 H [00:19]

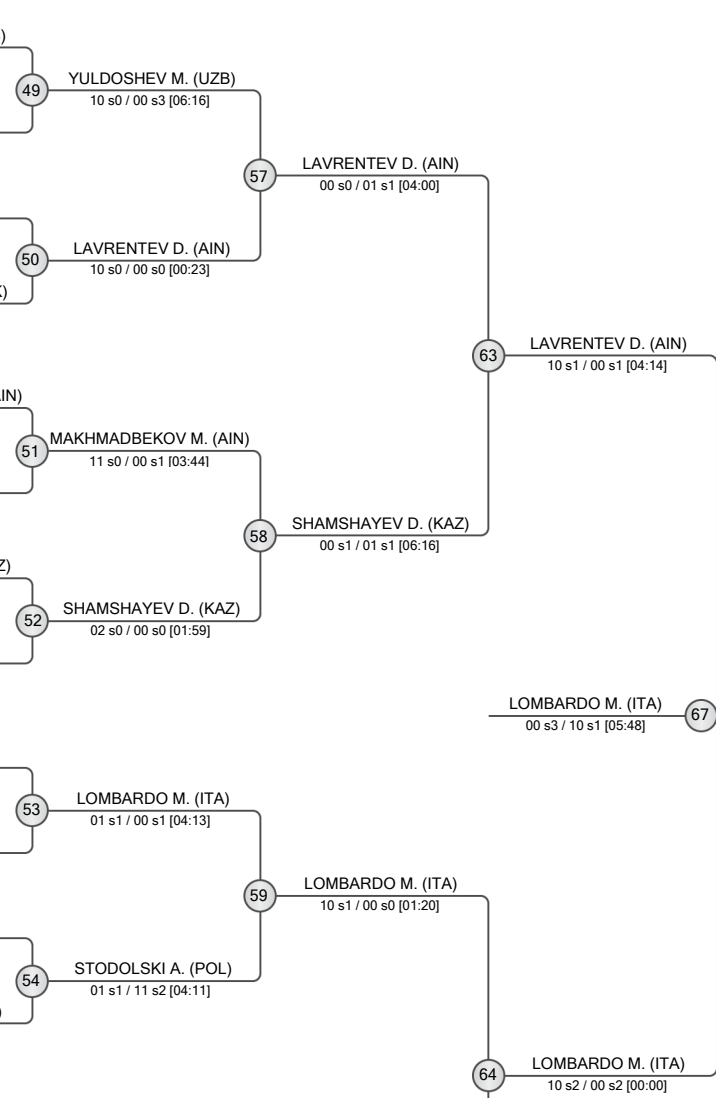

FINAL RESULTS		
1.	LOMBARDO Manuel	ITA
2.	LAVRENTEV Danil	AIN
3.	AKHADOV Shakhram	UZB
4.	NOMANOV Obidkhon	UZB
5.	MAKHMADBEKOV Makhmadbek	AIN
6.	SHAMSHAYEV Daniyar	KAZ
7.	YULDOSHEV Murodjon	UZB
8.	STODOLSKI Adam	POL





Tashkent Grand Slam 2024

Uzbekistan, Tashkent, 1-3 Mar 2024

-81 kg

Men (41)

POOL A

	CASSE Matthias	BEL
	MUSOEV Sunatullo	TKJ
	KHALMURZAEV Khasan	AIN
	MUSSAYEV Ruslan	KAZ
	MURTOZOEV Nurbek	UZB
	TATALASHVILI Nugzari	UAE
	GRAMATIKOV Georgi	BUL
	KOPECKY Adam	CZE
	SVIDRAK Mykhailo	UKR
	ARAB Sibghatullah	IRT

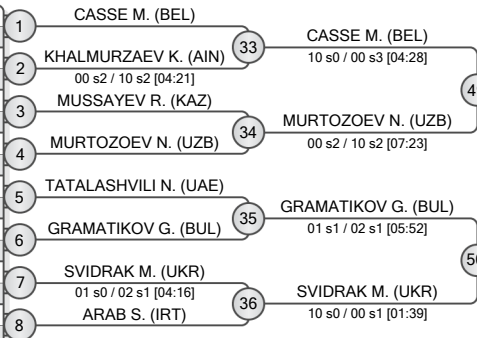

POOL B

	ALBAYRAK Vedat	TUR
	GRAMKOW Tim	GER
	ALBALI Abdulelah	KSA
	LATISEV Mihail	MDA
	GAMBA Giacomo	ITA
	NAGASE Takanori	JPN
	GERELTUYA Bolor-Ochir	MGL
	MASABIROV Asad	KGZ
	FERNANDO Joao	POR
	SOBIROV Muso	UZB

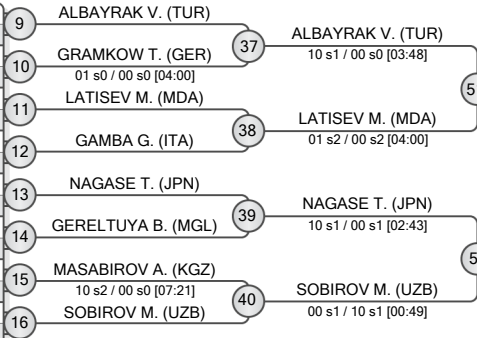

POOL C

	BORCHASHVILI Shamil	AUT
	STERPU Victor	MDA
	KLADNOV Arsenii	KGZ
	DEL ORBE CORTORREAL Medickson	DOM
	TURAEV Khikmatillokh	UZB
	MUKI Sagi	ISR
	STEWART Max	JAM
	ABDELGHANY Abdelrahman	EGY
	SULCA Adrian	ROU
	ALHARBI Mohammed	KSA
	APRAHAMIAN Alain	URU

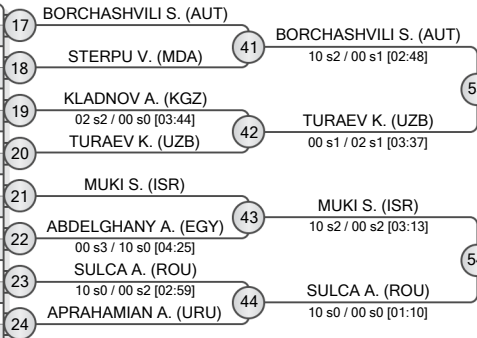

POOL D

	UNGVARI Attila	HUN
	SAYFIDINZODA Sayfidin	TKJ
	AYHANOV Agajan	TKM
	RAJABLI Omar	AZE
	BOLTABOEV Sharofiddin	UZB
	ZHUBANAZAR Abylaikhan	KAZ
	KARAPETYAN David	AIN
	AREGBA Arnaud	FRA
	MENDIOLA IZQUIETA Jose Maria	ESP
	MOUTII Achraf	MAR

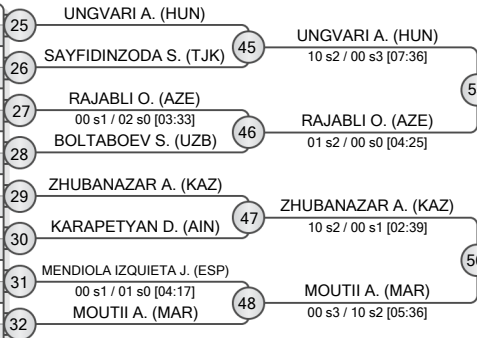

REPECHAGE

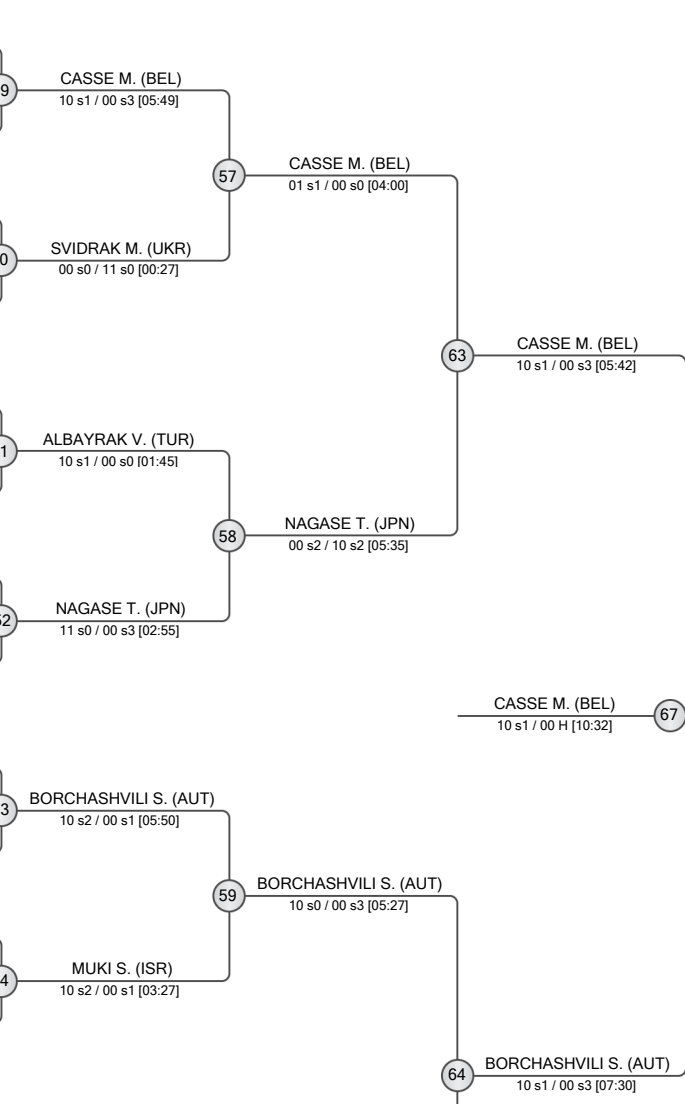

FINAL RESULTS	
1.	CASSE Matthias BEL
2.	BORCHASHVILI Shamil AUT
3.	SVIDRAK Mykhailo UKR
3.	NAGASE Takanori JPN
5.	RAJABLI Omar AZE
5.	ZHUBANAZAR Abylaikhan KAZ
7.	ALBAYRAK Vedat TUR
7.	MUKI Sagi ISR





Tashkent Grand Slam 2024

Uzbekistan, Tashkent, 1-3 Mar 2024

-90 kg

Men (39)

POOL A

1	BOBONOV Davlat (UZB)	BOBONOV D. (UZB)
2	ISHENBAEV Anarbek (KGZ)	ISHENBAEV A. (KGZ) 33
3	GOMES Marcelo (BRA)	GOMES M. (BRA) 01 s2 / 00 s0 [04:00]
4	GRIGORIAN Aram (UAE)	GRIGORIAN A. (UAE) 02 s0 / 00 s0 [03:00]
5	KLAMMERT David (CZE)	KLAMMERT D. (CZE) 34
6	NYMAN Marcus (SWE)	NYMAN M. (SWE)
7	GOZ Roland (HUN)	GOZ R. (HUN) 35
8	SIDORYK Aliaksandr (AIN)	SIDORYK A. (AIN) 10 s0 / 00 s3 [01:19]
9	MURODOV Akmal (TJK)	MURODOV A. (TJK) 36
10	FLORENTINO Robert (DOM)	FLORENTINO R. (DOM) 00 s0 / 10 s0 [00:19]

POOL B

9	PARLATI Christian (ITA)	PARLATI C. (ITA)
10	VISAN Vlad (ROU)	VISAN V. (ROU) 37
11	SHARIPOV Shakhzoduxja (UZB)	SHARIPOV S. (UZB)
12	CHOUCHI Sami (BEL)	CHOUCHI S. (BEL) 38
13	MAAN Karanjit Singh (IND)	MAAN K. (IND) 10 s0 / 00 s0 [00:28]
14	IVANOV Ivaylo (BUL)	IVANOV I. (BUL)
15	ARAPOV Aidar (KAZ)	ARAPOV A. (KAZ) 39
16	MATIJASS Martin (GER)	MATIJASS M. (GER) 01 s1 / 00 s2 [04:55]
17	EDILSULTANOV Ikhvan (AIN)	EDILSULTANOV I. (AIN)
18	JAYNE John (USA)	JAYNE J. (USA) 40
19		EDILSULTANOV I. (AIN) 11 s1 / 00 s2 [04:00]

POOL C

17	SHEROV Erlan (KGZ)	SHEROV E. (KGZ)
18	NERPEL Gergely (HUN)	NERPEL G. (HUN) 41
19	CRET Alex (ROU)	CRET A. (ROU)
20	GANTULGA Altanbagana (MGL)	GANTULGA A. (MGL) 42
21	DIAO Abderahmane (SEN)	DIAO A. (SEN) 02 s0 / 00 s2 [01:37]
22	USTOPIRIYON Komronshokh (TJK)	USTOPIRIYON K. (TJK)
23	VARAPAYEU Yahor (AIN)	VARAPAYEU Y. (AIN) 43
24	FERREIRA Giovanni (BRA)	FERREIRA G. (BRA) 00 s1 / 01 s2 [04:00]
25	KURBONMURODOV Jaloliddin (UZB)	KURBONMURODOV J. (UZB) 44
26	TSELIDIS Theodoros (GRE)	TSELIDIS T. (GRE) 00 s3 / 10 s2 [05:40]

POOL D

25	SILVA MORALES Ivan Felipe (CUB)	SILVA MORALES I. (CUB)
26	AVAZMURADOV Azizbek (UZB)	AVAZMURADOV A. (UZB) 45
27	SAGAIPOV Caramnob (LBN)	SAGAIPOV C. (LBN)
28	KALJULAI Klen Kristofer (EST)	KALJULAI K. (EST) 46
29	IGOLNIKOV Mikhail (AIN)	IGOLNIKOV M. (AIN) 10 s0 / 00 H [01:14]
30	SCHARFETTER Thomas (AUT)	SAGAIPOV C. (LBN) 47
31	AGHASARYAN Davit (USA)	SCHARFETTER T. (AUT) 48
32	ACHYLDYEV Mamedaly (TKM)	ACHYLDYEV M. (TKM) 10 s1 / 00 s0 [01:39]
33	DOSSYMOV Kudyret (KAZ)	IGOLNIKOV M. (AIN) 49
34		IGOLNIKOV M. (AIN) 10 s0 / 00 s0 [00:08]
35		DOSSYMOV K. (KAZ) 50
36		DOSSYMOV K. (KAZ) 00 s1 / 10 s0 [01:34]

REPECHAGE

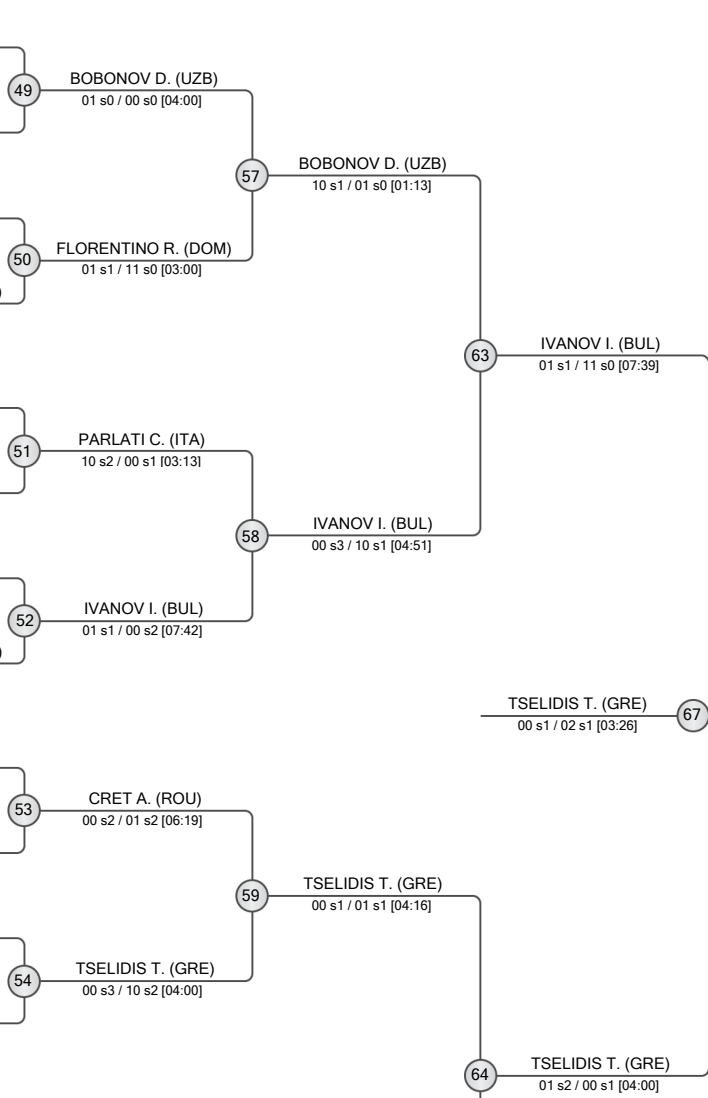
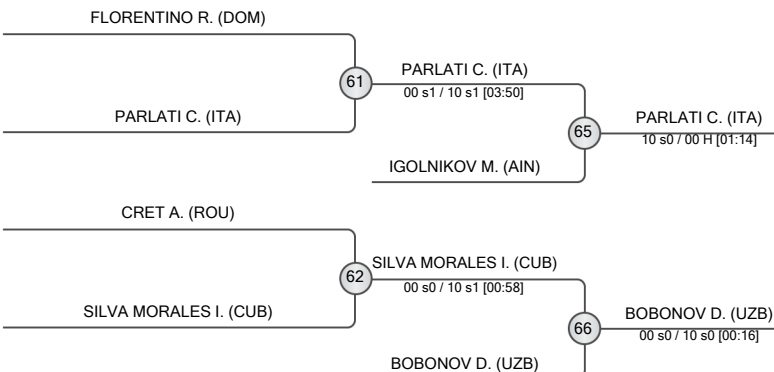

FINAL RESULTS		
1.	TSELIDIS Theodoros	GRE
2.	IVANOV Ivaylo	BUL
3.	PARLATI Christian	ITA
4.	BOBONOV Davlat	UZB
5.	IGOLNIKOV Mikhail	AIN
6.	SILVA MORALES Ivan Felipe	CUB
7.	FLORENTINO Robert	DOM
8.	CRET Alex	ROU





Tashkent Grand Slam 2024

Uzbekistan, Tashkent, 1-3 Mar 2024

-100 kg

Men (31)

POOL A

	KANIKOVSKIY Matvey	AIN
	KEEVE Nathaniel	USA
	SAVYTSKIY Anton	UKR
	BUZACARINI Rafael	BRA
	JANDREEV Shermukhammad	UZB
	MADZHIDOV Dzhakhongir	TJK
	PANDARI CHANDRAN Aswin	IND

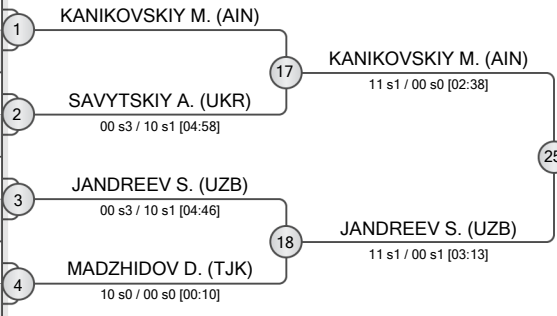

POOL B

	ADAMIAN Arman	AIN
	FONSECA Jorge	POR
	SHAGATAYEV Bekzat	KAZ
	SARSENBAEV Ernazar	UZB
	KOSTOEV Dzhafar	UAE
	GOGOLADZE Imeda	GEO
	NIKIFOROV Toma	BEL
	MUNGAI Nicholas	ITA

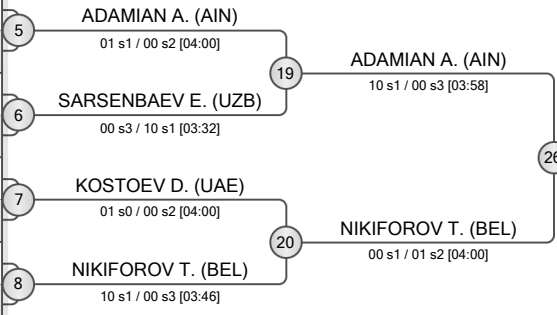

POOL C

	TUROBOYEV Muzaffarbek	UZB
	MAJANOV Baymyrat	TKM
	KROUSSANIOTAKIS Georgios	CYP
	PIRELLI Gennaro	ITA
	GONCALVES Leonardo	BRA
	MUKETE Daniel	AIN
	KUCZERA Piotr	POL
	GEORGIEV Boris	BUL

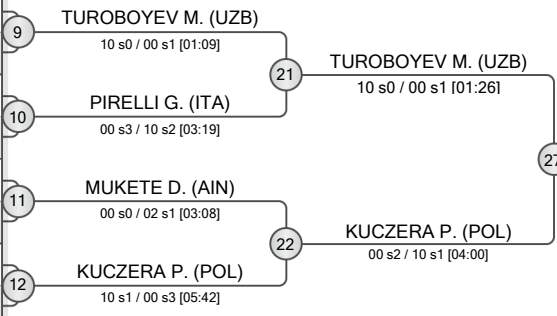

POOL D

	PALTCHIK Peter	ISR
	LIPARTELIANI Varlam	GEO
	ARAI Dota	JPN
	SINGH Avtar	IND
	SHARKHAN Nurlykhan	KAZ
	SHORAKHMATOV Rustam	UZB
	EICH Daniel	SUI
	KAPPELMEIER Kilian	GER

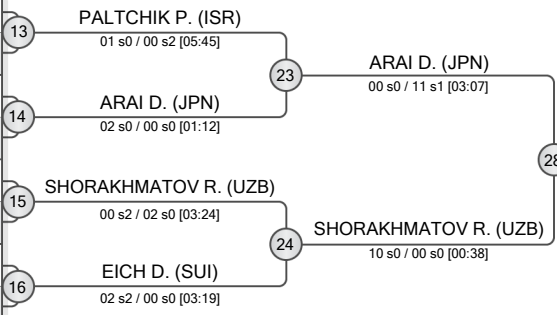

REPECHAGE

JANDREEV S. (UZB)	29	NIKIFOROV T. (BEL)	
NIKIFOROV T. (BEL)		30	KUCZERA P. (POL)
KUCZERA P. (POL)		31	SHORAKHMATOV R. (UZB)
SHORAKHMATOV R. (UZB)		32	ADAMIAN A. (AIN)

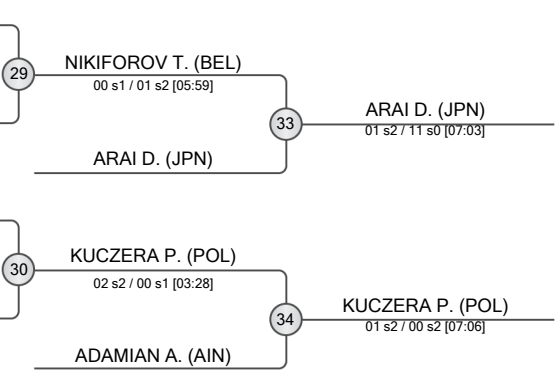

35 TUROBOYEV M. (UZB) [00 s0 / 10 s0 [00:13]]

FINAL RESULTS	
1. TUROBOYEV Muzaffarbek	UZB
2. KANIKOVSKIY Matvey	AIN
3. ARAI Dota	JPN
3. KUCZERA Piotr	POL
5. NIKIFOROV Toma	BEL
5. ADAMIAN Arman	AIN
7. JANDREEV Shermukhammad	UZB
7. SHORAKHMATOV Rustam	UZB





Tashkent Grand Slam 2024

Uzbekistan, Tashkent, 1-3 Mar 2024

+100 kg

Men (27)

POOL A

	TASOEV Inal	AIN
	KAZHYBAYEV Yerassyl	KAZ
	SAPARBAEV Khamzat	FRA
	ERTUG Munir	TUR
	MIRMAMADOV Shakarmamad	TJK
	TUROBOYEV Utkirbek	UZB
	GADEAU Marvin	MON

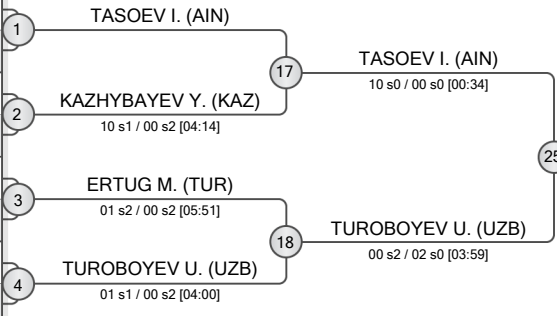

POOL B

	BASHAEV Tamerlan	AIN
	BALYEVSKYY Yevheniy	UKR
	RAVSHANKULOV Islombek	UZB
	KAGEURA Kokoro	JPN
	ANANI Kwadjo	ITA
	NDIAYE Mbagnick	SEN

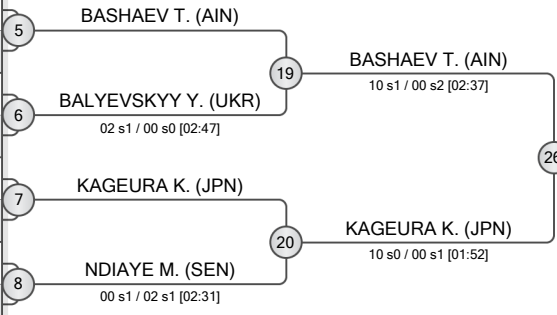

POOL C

	YUSUPOV Alisher	UZB
	KRIKBAY Galymzhan	KAZ
	ZHOLDOSHKAZIEV Emirkhan	KGZ
	SIPOCZ Richard	HUN
	TATAROGLU Ibrahim	TUR
	ANTONIOU Giannis	CYP
	SZCZUROWSKI Kacper	POL

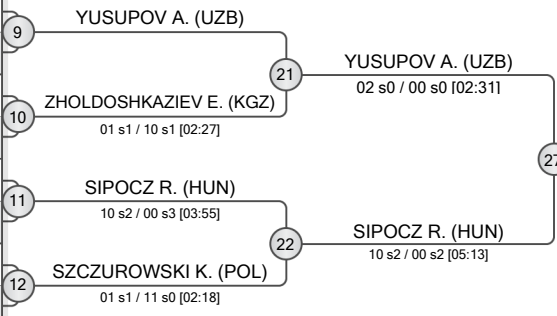

POOL D

	GRANDA Andy	CUB
	OTA Hyoga	JPN
	HORIUCHI Philip	USA
	BAKHTIYOROV Shokhrukhkhon	UZB
	FREY Johannes	GER
	GHANGAS Yash	IND
	MANAIE Saud	KSA

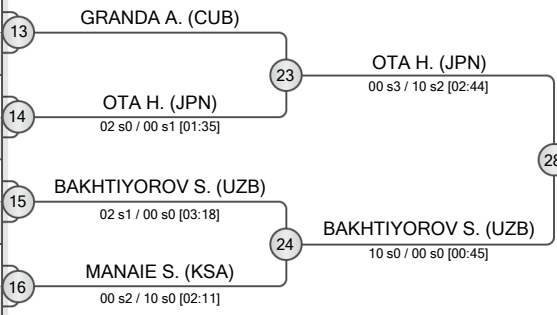

REPECHAGE

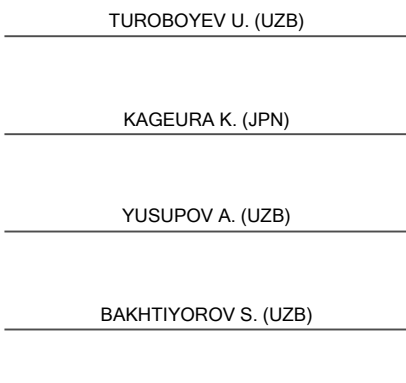

OTA H. (JPN) [06:08] → 35

OTA H. (JPN) [00:27] → 32

FINAL RESULTS	
1.	OTA Hyoga (JPN)
2.	BASHAEV Tamerlan (AIN)
3.	KAGEURA Kokoro (JPN)
3.	TASOEV Inal (AIN)
5.	SIPOCZ Richard (HUN)
5.	BAKHTIYOROV Shokhrukhkhon (UZB)
7.	TUROBOYEV Utkirbek (UZB)
7.	YUSUPOV Alisher (UZB)





Tashkent Grand Slam 2024

Uzbekistan, Tashkent, 1-3 Mar 2024

-52 kg

Women (33)

POOL A

1	BUCHARD Amandine (FRA)	1	BUCHARD A. (FRA)
2	PERNA Kenya (ITA)	33	BUCHARD A. (FRA)
3	VALIYEVA Aydan (AZE)	34	KALETA A. (POL)
4	KALETA Aleksandra (POL)	34	KALETA A. (POL)
5	IRAOUI Soumiya (MAR)	35	IRAOUI S. (MAR)
6	PULJIZ Ana Viktorija (CRO)	35	IRAOUI S. (MAR)
7	WURFEL Annika (GER)	36	FUJISHIRO K. (JPN)
8	FUJISHIRO Kokoro (JPN)	36	FUJISHIRO K. (JPN)

POOL B

9	BISHRELT Khorloodoi (UAE)	9	BISHRELT K. (UAE)
10	DANILOVICH Kseniya (AIN)	37	BISHRELT K. (UAE)
11	YEREZHEPOVA Aruzhan (KAZ)	38	YEREZHEPOVA A. (KAZ)
12	AKHMATOVA Mukhayyo (UZB)	38	YEREZHEPOVA A. (KAZ)
13	GNETO Astride (FRA)	39	GNETO A. (FRA)
14	DIMITROVA Gabriela (BUL)	39	GNETO A. (FRA)
15	SHEN Yi-Hsi (TPE)	40	MUMINOVA A. (TJK)
16	MUMINOVA Akhliya (TJK)	40	MUMINOVA A. (TJK)

POOL C

17	GILES Chelsie (GBR)	17	GILES C. (GBR)
18	CHOPADE Shraddha Kadubal (IND)	41	GILES C. (GBR)
19	NURITDINOVA Maya (TKM)	42	ZHU Y. (CHN)
20	ZHU Yeqing (CHN)	42	ZHU Y. (CHN)
21	MAMMADALIYEVA Gultaj (AZE)	43	BORISOVA G. (AIN)
22	BORISOVA Glafira (AIN)	43	BORISOVA G. (AIN)
23	JURAEVA Gulkhayo (UZB)	44	JURAEVA G. (UZB)
24	SCIACOVELLI Micaela (ITA)	44	JURAEVA G. (UZB)
	KOCHER Fabienne (SUI)		KOCHER F. (SUI)

POOL D

25	BALLHAUS Mascha (GER)	25	BALLHAUS M. (GER)
26	LKHAGVASUREN Sosorbaram (MGL)	45	LKHAGVASUREN S. (MGL)
27	NUGAEVA Liliia (AIN)	46	MARTINEZ P. (MEX)
28	MARTINEZ Paulina (MEX)	46	MARTINEZ P. (MEX)
29	KADAMBOEVA Sita (UZB)	47	SIDEROT M. (POR)
30	SIDEROT Maria (POR)	47	SIDEROT M. (POR)
31	ASVESTA Sofia (CYP)	48	ASVESTA S. (CYP)
32	ABDESHOVA Balnur (KAZ)	48	ABDESHOVA B. (KAZ)

REPECHAGE

FUJISHIRO K. (JPN)	61	FUJISHIRO K. (JPN)	61	FUJISHIRO K. (JPN)
GNETO A. (FRA)	61	FUJISHIRO K. (JPN)	61	FUJISHIRO K. (JPN)
GILES C. (GBR)	62	GILES C. (GBR)	62	GILES C. (GBR)
ASVESTA S. (CYP)	62	GILES C. (GBR)	62	GILES C. (GBR)
LKHAGVASUREN S. (MGL)	65	LKHAGVASUREN S. (MGL)	65	LKHAGVASUREN S. (MGL)
LKHAGVASUREN S. (MGL)	65	LKHAGVASUREN S. (MGL)	65	LKHAGVASUREN S. (MGL)
GILES C. (GBR)	66	GILES C. (GBR)	66	GILES C. (GBR)
ASVESTA S. (CYP)	66	GILES C. (GBR)	66	GILES C. (GBR)
BISHRELT K. (UAE)	66	GILES C. (GBR)	66	GILES C. (GBR)

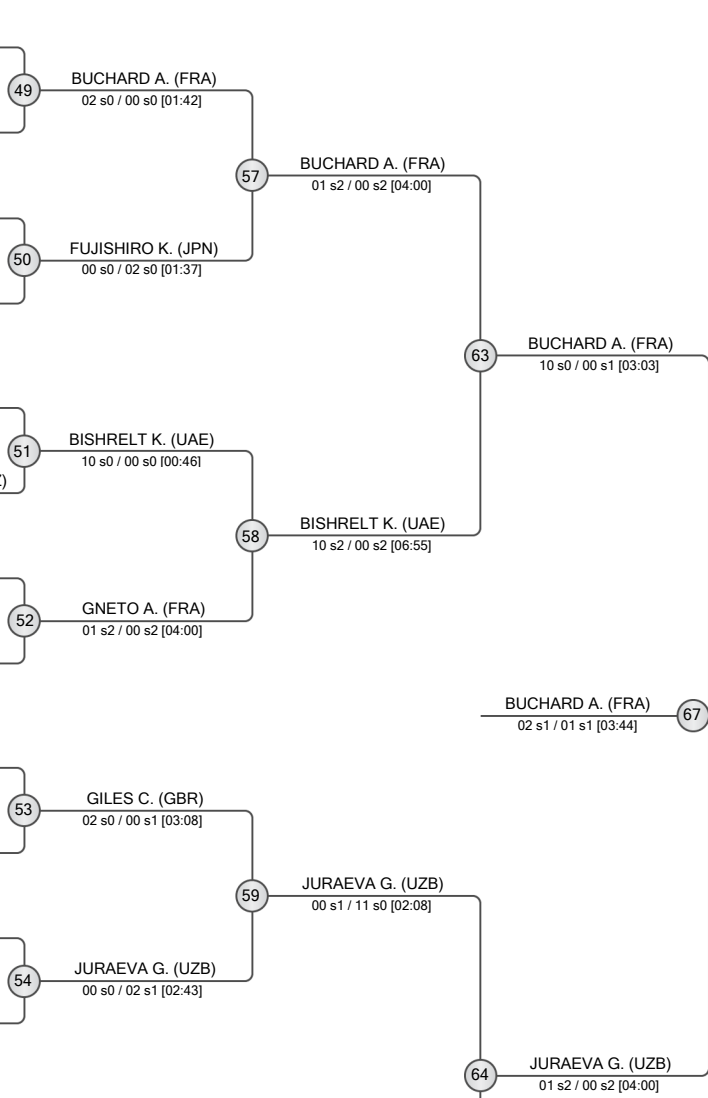

FINAL RESULTS		
1.	BUCHARD Amandine	FRA
2.	JURAEVA Gulkhayo	UZB
3.	LKHAGVASUREN Sosorbaram	MGL
3.	GILES Chelsie	GBR
5.	FUJISHIRO Kokoro	JPN
5.	BISHRELT Khorloodoi	UAE
7.	GNETO Astride	FRA
7.	ASVESTA Sofia	CYP





Tashkent Grand Slam 2024

Uzbekistan, Tashkent, 1-3 Mar 2024

-57 kg

Women (31)

POOL A

	SILVA Rafaela	BRA
	PODOLAK Arleta	POL
	MAKSETBAEVA Yulyana	UZB
	KAJZER Kaja	SLO
	BOZKURT Hasret	TUR
	LIBEER Mina	BEL
	GULBOEVA Fazilat	TJK

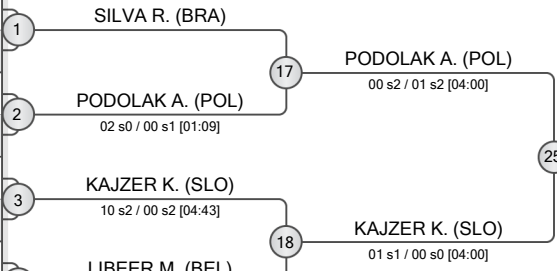

POOL B

	STARKE Pauline	GER
	AMINOVA Shukurjon	UZB
	HOLGUIN Mariah	USA
	SABIROVA Chinora	TKM
	CAI Qi	CHN
	GALITSKAIA Kseniia	AIN
	ZHOLDOSHEVA Zhanar	KGZ
	GNETO Priscilla	FRA

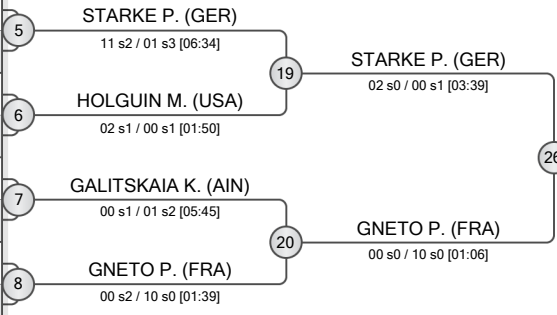

POOL C

	FUNAKUBO Haruka	JPN
	KOWALCZYK Julia	POL
	BATSUKH Altantsetseg	UAE
	ERMAGANBETOVA Nilufar	UZB
	BALLHAUS Seija	GER
	KUSSAKBAYEVA Bakyt	KAZ
	MOURYA Yamini	IND
	ILIEVA Ivelina	BUL

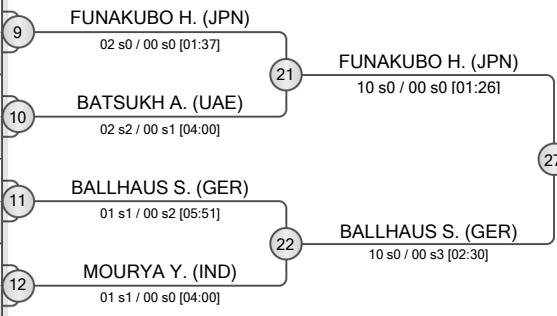

POOL D

	NELSON LEVY Timna	ISR
	MARTIN Jasmine	RSA
	PARDAYEVA Maysa	TKM
	REDJEPOVA Farangiz	UZB
	KURBONMAMADOVA Daria	AIN
	NAIRNE Lele	GBR
	YILDIZ Ozlem	TUR
	ALIZADA Fidan	AZE

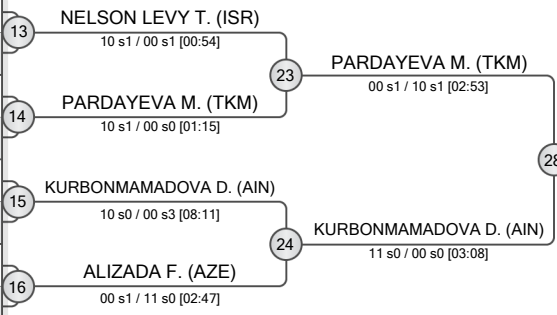

REPECHAGE

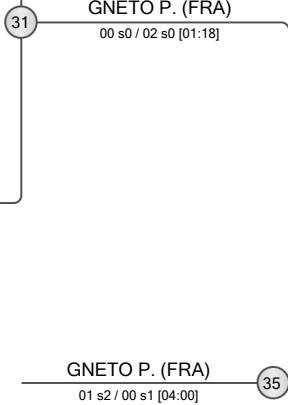
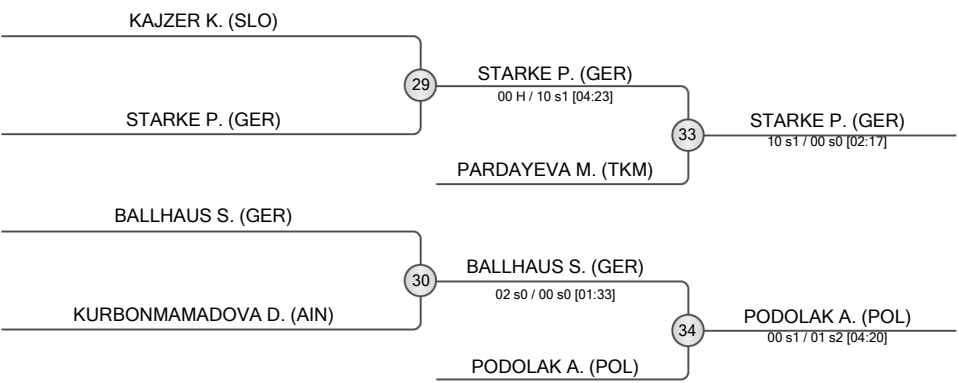

FINAL RESULTS	
1. GNETO Priscilla	FRA
2. FUNAKUBO Haruka	JPN
3. STARKE Pauline	GER
3. PODOLAK Arleta	POL
5. PARDAYEVA Maysa	TKM
5. BALLHAUS Seija	GER
7. KAJZER Kaja	SLO
7. KURBONMAMADOVA Daria	AIN





Tashkent Grand Slam 2024

Uzbekistan, Tashkent, 1-3 Mar 2024

-63 kg

Women (41)

POOL A

1	RENSHALL Lucy (GBR)	RENSHALL L. (GBR)
2	POHL Dena (GER)	POHL D. (GER) 33
3	KARIMDJANOVA Asal (UZB)	LILUASHVILI D. (AIN)
4	LILUASHVILI Dali (AIN)	LILUASHVILI D. (AIN) 34
5	DEL TORO CARVAJAL Maylin (CUB)	DEL TORO CARVAJAL M. (CUB)
6	QUADROS Ketleyn (BRA)	QUADROS K. (BRA)
7	SOTNIKOVA Kristina (KAZ)	RUSSO S. (ITA) 35
8	RUSSO Savita (ITA)	RUSSO S. (ITA) 35
9	BOLD Gankhaich (MGL)	BOLD G. (MGL)
10	TATSUKAWA Momo (JPN)	TATSUKAWA M. (JPN) 36

POOL B

9	LESKI Andreja (SLO)	LESKI A. (SLO)
10	TOKAS Himanshi (IND)	LESKI A. (SLO) 37
11	WATANABE Kiyomi (PHI)	TOKAS H. (IND) 11 s0 / 00 s0 [03:31]
12	KRISTO Katarina (CRO)	KRISTO K. (CRO)
13	VAZQUEZ FERNANDEZ Laura (ESP)	VAZQUEZ FERNANDEZ L. (ESP) 38
14	SHEMESH Inbal (ISR)	SHEMESH I. (ISR)
15	DASHKINOVA Zulhumar (TKM)	DASHKINOVA Z. (TKM) 39
16	ODINAEVA Mavluda (TJK)	ODINAEVA M. (TJK) 02 s0 / 00 s1 [03:18]
17	ISOKOVA Sevinch (UZB)	ISOKOVA S. (UZB)
18	ISAEVA Azhar (KGZ)	ISAEVA A. (KGZ) 40

POOL C

17	SHARIR Gili (ISR)	SHARIR G. (ISR)
18	NURULLOEVA Marjona (UZB)	NURULLOEVA M. (UZB) 41
19	SHARMA Unnati (IND)	TANG J. (CHN)
20	TANG Jing (CHN)	TANG J. (CHN) 42
21	SCHMIDT Agatha (GER)	SCHMIDT A. (GER)
22	TIMO Barbara (POR)	TIMO B. (POR)
23	IVANESCU Florentina (ROU)	IVANESCU F. (ROU) 43
24	KÖCHKONBAEVA Adina (KGZ)	NABEKURA N. (JPN)
25	NABEKURA Nami (JPN)	NABEKURA N. (JPN) 44
26	BADUROVA Kamila (AIN)	BADUROVA K. (AIN)

POOL D

25	AGBEGNEOU Clarisse (FRA)	AGBEGNEOU C. (FRA)
26	GUIMENDEGO Nadia Matchiko (CAF)	MAKRETSKAYA Y. (AIN)
27	MAKRETSKAYA Yana (AIN)	MAKRETSKAYA Y. (AIN) 45
28	KUYULOVA Esmigul (KAZ)	XUSANOVA S. (UZB)
29	XUSANOVA Sarvinoz (UZB)	XUSANOVA S. (UZB) 46
30	CABANA PEREZ Cristina (ESP)	CABANA PEREZ C. (ESP)
31	AWITI ALCARAZ Prisca (MEX)	AWITI ALCARAZ P. (MEX)
32	OBERAN Iva (CRO)	OBERAN I. (CRO) 47
33	FAVORINI Flavia (ITA)	FAVORINI F. (ITA)
34	MORAES Gabriella (BRA)	FAVORINI F. (ITA) 48
35	GARDASHKHANLI Aytaj (AZE)	GARDASHKHANLI A. (AZE)

REPECHAGE

61	POHL D. (GER)	POHL D. (GER) 01 s2 / 00 s0 [04:39]
62	SHEMESH I. (ISR)	SHEMESH I. (ISR)
63	SHARIR G. (ISR)	SHARIR G. (ISR) 01 s1 / 00 s1 [04:00]
64	OBERAN I. (CRO)	OBERAN I. (CRO)
65	NABEKURA N. (JPN)	NABEKURA N. (JPN) 00 s2 / 01 s1 [06:17]
66	LESKI A. (SLO)	LESKI A. (SLO) 00 s1 / 01 s0 [04:00]

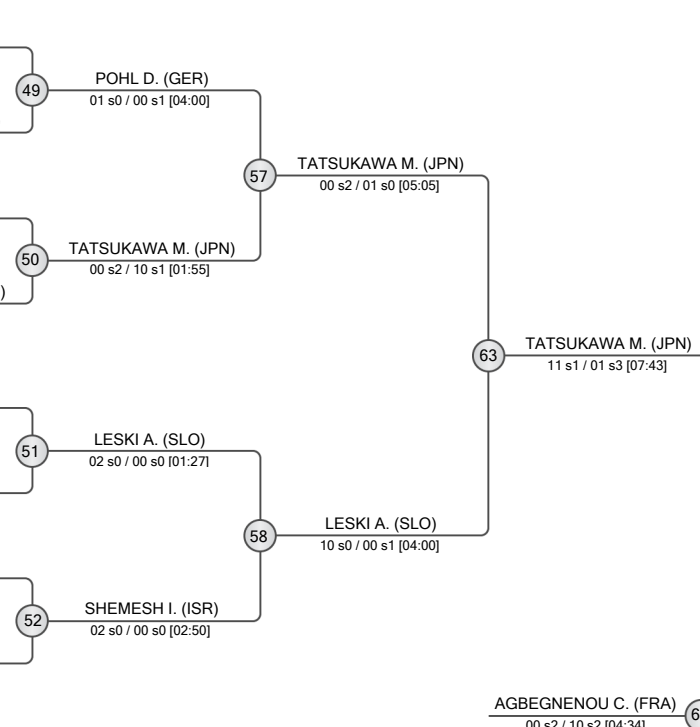

FINAL RESULTS		
1.	AGBEGNEOU Clarisse	FRA
2.	TATSUKAWA Momo	JPN
3.	NABEKURA Nami	JPN
4.	LESKI Andreja	SLO
5.	POHL Dena	GER
6.	SHARIR Gili	ISR
7.	SHEMESH Inbal	ISR
8.	OBERAN Iva	CRO





Tashkent Grand Slam 2024

Uzbekistan, Tashkent, 1-3 Mar 2024

-70 kg

Women (35)

POOL A

1	NIIZOE Saki	JPN
2	PILECKAITE Ugne	LTU
3	WROBLEWSKA Eliza	POL
4	CHODHARY Garima	IND
5	YEATS-BROWN Katie-Jemima	GBR
6	MATNIYAZOVA Gulnoza	UZB
7	NOVITZKI Adelina	ISR
8	BATSUURI Nyam-Erdene	MGL
9	PINA Tais	POR

1	NIIZOE S. (JPN)	33	NIIZOE S. (JPN)
2	PILECKAITE U. (LTU)		10 s0 / 00 s1 [02:03]
3	WROBLEWSKA E. (POL)		10 s0 / 00 s0 [00:43]
4	YEATS-BROWN K. (GBR)	34	YEATS-BROWN K. (GBR)
5	MATNIYAZOVA G. (UZB)		01 s0 / 10 s0 [01:25]
6	NOVITZKI A. (ISR)	35	MATNIYAZOVA G. (UZB)
7	BATSUURI N. (MGL)		11 s0 / 01 s1 [03:06]
8	PINA T. (POR)	36	PINA T. (POR)
			00 s3 / 10 s0 [02:37]

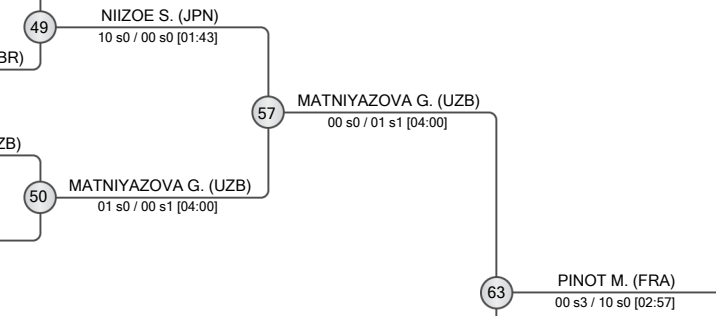

POOL B

9	TAIMAZOVA Madina	AIN
10	LIAO Yu-Jung	TPE
11	MUN Song Hui	PRK
12	PEDROTTI Irene	ITA
13	PINOT Margaux	FRA
14	RAZZOKBERDIEVA Khurshida	UZB
15	YU Dan	CHN
16	CARVALHO Luana	BRA

9	TAIMAZOVA M. (AIN)	37	TAIMAZOVA M. (AIN)
10	LIAO Y. (TPE)		10 s0 / 00 s2 [04:00]
11	MUN S. (PRK)		10 s2 / 00 s3 [07:22]
12	PEDROTTI I. (ITA)	38	MUN S. (PRK)
13	PINOT M. (FRA)		10 s2 / 00 s1 [03:06]
14	RAZZOKBERDIEVA K. (UZB)	39	PINOT M. (FRA)
15	YU D. (CHN)		10 s2 / 00 s1 [03:06]
16	CARVALHO L. (BRA)	40	CARVALHO L. (BRA)
			00 s0 / 02 s0 [01:08]

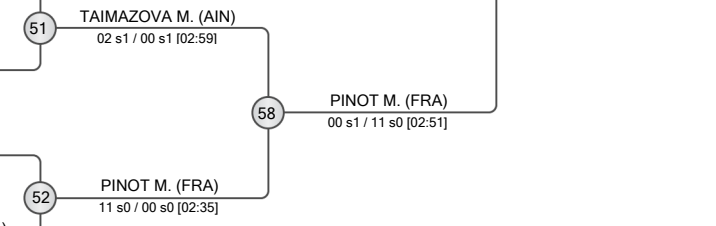

POOL C

17	BUTKEREIT Miriam	GER
18	KHRAMOIKINA Daria	AIN
19	SARANTSETSEG Lkhagvadulam	MGL
20	ERIKSSON Ida	SWE
21	GOMEZ FERIA Idelannis	CUB
22	PETERSEN POLLARD Kelly	GBR
23	NIANG Assmaa	MAR
24	ALMAZOVA Saule	KGZ
25	NAZAROVA Shokhista	UZB

17	BUTKEREIT M. (GER)	41	BUTKEREIT M. (GER)
18	KHRAMOIKINA D. (AIN)		01 s1 / 00 s2 [04:59]
19	SARANTSETSEG L. (MGL)		10 s2 / 00 s3 [09:30]
20	ERIKSSON I. (SWE)	42	ERIKSSON I. (SWE)
21	GOMEZ FERIA I. (CUB)		01 s0 / 00 s2 [04:30]
22	PETERSEN POLLARD K. (GBR)	43	PETERSEN POLLARD K. (GBR)
23	NIANG A. (MAR)		10 s1 / 00 s1 [03:14]
24	ALMAZOVA S. (KGZ)	44	NAZAROVA S. (UZB)
25	NAZAROVA S. (UZB)		00 s0 / 02 s1 [02:38]

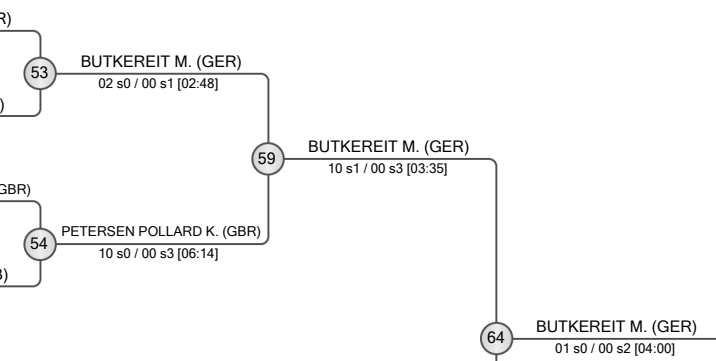

POOL D

25	RODRIGUEZ Elvismar	VEN
26	TOKAREVA Ekaterina	KAZ
27	GERCSAK Szabina	HUN
28	TAKHELLAMBAM Inunganbi	IND
29	SCOCCIMARRO Giovanna	GER
30	KODIROVA Barchinoy	UZB
31	DE VOOGD Margit	NED
32	FRONER Ellen	BRA
33	CHAYEB Aqulina	LBN

25	RODRIGUEZ E. (VEN)	45	TOKAREVA E. (KAZ)
26	TOKAREVA E. (KAZ)		00 s2 / 01 s2 [07:52]
27	GERCSAK S. (HUN)		10 s1 / 00 s3 [02:28]
28	TAKHELLAMBAM I. (IND)	46	GERCSAK S. (HUN)
29	SCOCCIMARRO G. (GER)		10 s1 / 00 s2 [04:14]
30	KODIROVA B. (UZB)	47	SCOCCIMARRO G. (GER)
31	DE VOOGD M. (NED)		10 s0 / 00 s3 [06:10]
32	FRONER E. (BRA)	48	DE VOOGD M. (NED)
33	CHAYEB A. (LBN)		10 s0 / 00 s1 [02:48]

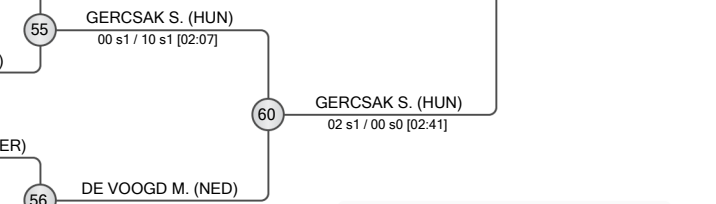

REPECHAGE

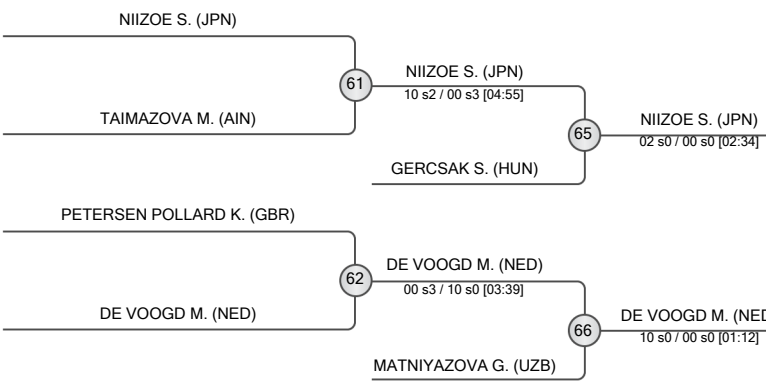

FINAL RESULTS		
1.	BUTKEREIT Miriam	GER
2.	PINOT Margaux	FRA
3.	NIIZOE Saki	JPN
4.	DE VOOGD Margit	NED
5.	GERCSAK Szabina	HUN
6.	MATNIYAZOVA Gulnoza	UZB
7.	TAIMAZOVA Madina	AIN
8.	PETERSEN POLLARD Kelly	GBR





Tashkent Grand Slam 2024

Uzbekistan, Tashkent, 1-3 Mar 2024

-78 kg

Women (32)

POOL A

	LANIR Inbar	ISR	1
	NARUKHAMEDOVA Shakhida	KGZ	2
	GRITSENKO Margarita	KAZ	2
	DUDENAITE Migle Julija	LTU	3
	POSVITE Fanny Estelle	FRA	3
	KANTSAVAYA Darya	AIN	4
	KURBANBAEVA Iriskhon	UZB	4
	PAVIC Petrunjela	CRO	4

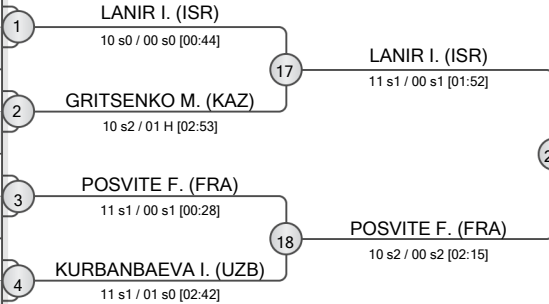

POOL B

	BOEHM Alina	GER	5
	OTGONBAYAR Khuslen	MGL	6
	YULDASHEVA Nodira	UZB	6
	HSU WANG Shu Huei	TPE	7
	SAMPAIO Patricia	POR	7
	STANGHERLIN Giorgia	ITA	8
	SILVESTRE Eiraima	DOM	8
	REID Emma	GBR	8

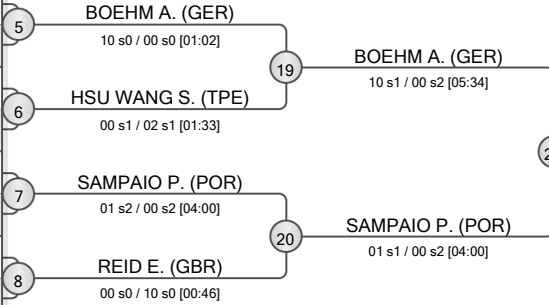

POOL C

	BELLANDI Alice	ITA	9
	KHOLMURODOVA Farangiz	UZB	10
	PRODAN Karla	CRO	10
	PACUT-KLOCZKO Beata	POL	11
	TAKAYAMA Rika	JPN	11
	MICHAELIDOU Zanet	CYP	12
	JANGELDINA Aruna	KAZ	12
	MURADOVA Yyldyz	TKM	12

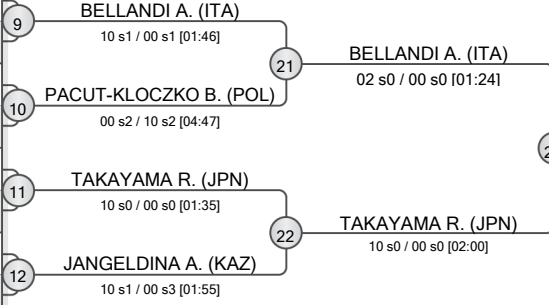

POOL D

	WAGNER Anna-Maria	GER	13
	SHMELEVA Antonina	AIN	14
	BUTTIGIEG Chloe	FRA	14
	VAN HEEMST Yael	NED	15
	MA Zhenzhao	CHN	15
	YULDOSHOVA Shirinjon	UZB	16
	BATBAYAR Erdenet-Od	MGL	16
	OEDA Ikumi	THA	16

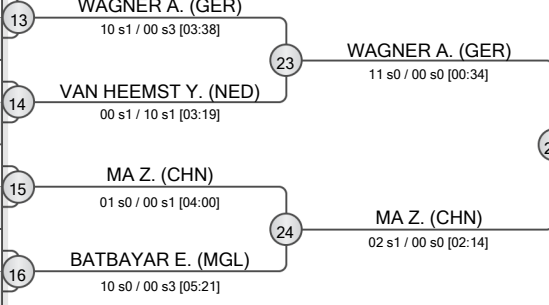

REPECHAGE

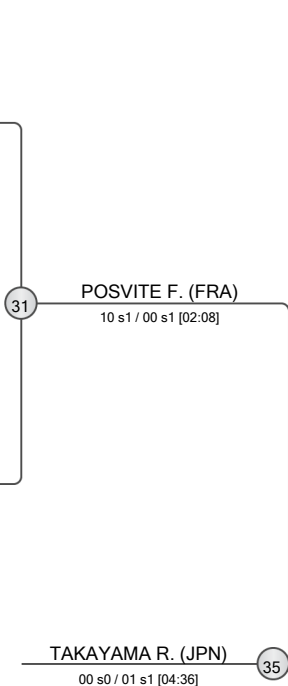
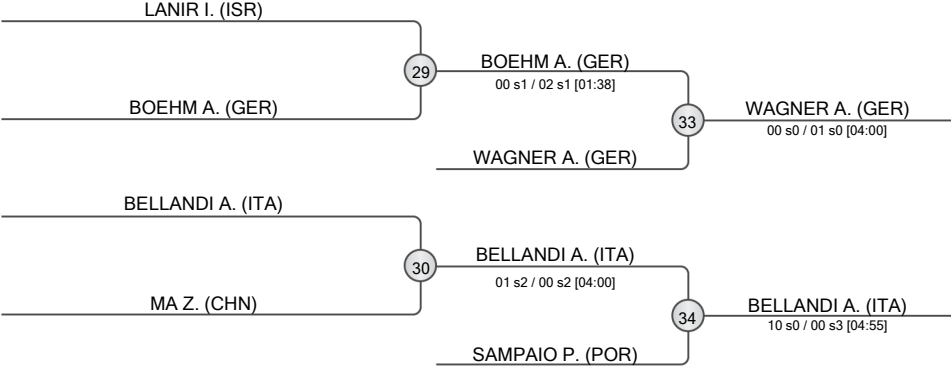

FINAL RESULTS		
1.	TAKAYAMA Rika	JPN
2.	POSVITE Fanny Estelle	FRA
3.	WAGNER Anna-Maria	GER
3.	BELLANDI Alice	ITA
5.	BOEHM Alina	GER
5.	SAMPAIO Patricia	POR
7.	LANIR Inbar	ISR
7.	MA Zhenzhao	CHN





Tashkent Grand Slam 2024

Uzbekistan, Tashkent, 1-3 Mar 2024

+ 78 kg

Women (33)

POOL A

HERSHKO Raz	ISR	1	HERSHKO R. (ISR)
LUCHT Renee	GER	2	LUCHT R. (GER)
STARTSEVA Elis	AIN	3	STARTSEVA E. (AIN)
AMARSAIKHAN Adiyasuren	MGL	4	AMARSAIKHAN A. (MGL)
OZTURK Hilal	TUR	5	OZTURK H. (TUR)
MORILLO Moira	DOM	6	MORILLO M. (DOM)
NIZOMADDINOVA Durdona	UZB	7	SANTOS G. (BRA)
SANTOS Giovanna	BRA	8	SANTOS G. (BRA)
MARATOVA Nazgul	KAZ		MARATOVA N. (KAZ)

POOL B

NUNES Rochele	POR	9	NUNES R. (POR)
ORTIZ Idalys	CUB	10	ORTIZ I. (CUB)
ALQAHTANI Tahani	KSA	11	ALQAHTANI T. (KSA)
KURAMBOEVA Fotima	UZB	12	KURAMBOEVA F. (UZB)
OZDEMIR Kayra	TUR	13	OZDEMIR K. (TUR)
TAKAHASHI Ruri	JPN	14	TAKAHASHI R. (JPN)
SUTALO Ivana	CRO	15	SUTALO I. (CRO)
MARENCO Izayana	NCA	16	MARENCO I. (NCA)

POOL C

XU Shiyan	CHN	17	XU S. (CHN)
SEGAWA Maya	JPN	18	SEGAWA M. (JPN)
ILMATOVA Rinata	UZB	19	ILMATOVA R. (UZB)
SIMONETTI Erica	ITA	20	SIMONETTI E. (ITA)
ZABIC Milica	SRB	21	ZABIC M. (SRB)
DIJKSTRA Carmen	NED	22	DIJKSTRA C. (NED)
BERLIKASH Kamila	KAZ	23	BERLIKASH K. (KAZ)
BOUIZGARNE Samira	GER	24	BOUIZGARNE S. (GER)

POOL D

FONTAINE Lea	FRA	25	FONTAINE L. (FRA)
RADIC Tina	CRO	26	RADIC T. (CRO)
WOLSZCZAK Kinga	POL	27	WOLSZCZAK K. (POL)
VLADIMIROVA Daria	AIN	28	VLADIMIROVA D. (AIN)
SU Xin	CHN	29	SU X. (CHN)
TUKHTAMISHEVA Mokhtaroyim	UZB	30	TUKHTAMISHEVA M. (UZB)
MAAN Tulika	IND	31	MAAN T. (IND)
URDANETA Amarantha	VEN	32	URDANETA A. (VEN)

REPECHAGE

OZTURK H. (TUR)		61	OZTURK H. (TUR)
NUNES R. (POR)			
BOUIZGARNE S. (GER)			
FONTAINE L. (FRA)		62	FONTAINE L. (FRA)
FONTAINE L. (FRA)			
STARTSEVA E. (AIN)			

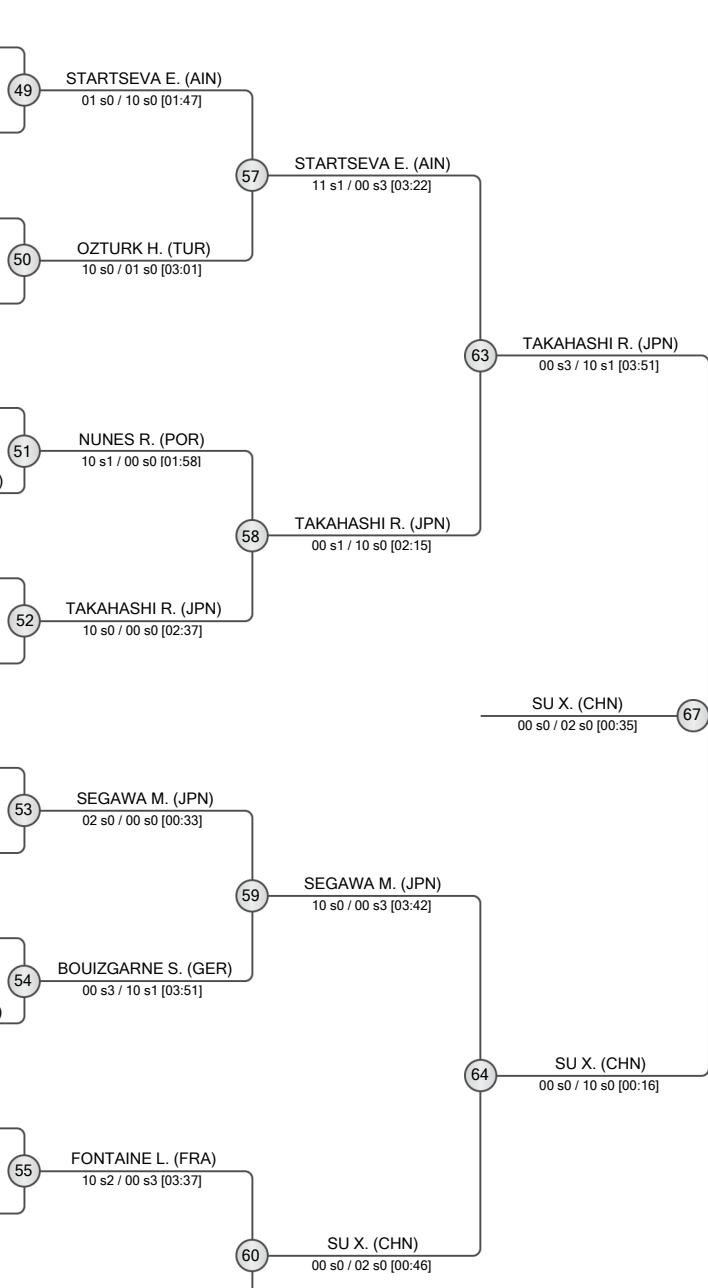

FINAL RESULTS		
1.	SU Xin	CHN
2.	TAKAHASHI Ruri	JPN
3.	SEGAWA Maya	JPN
3.	STARTSEVA Elis	AIN
5.	OZTURK Hilal	TUR
5.	FONTAINE Lea	FRA
7.	NUNES Rochele	POR
7.	BOUIZGARNE Samira	GER

