



Event Report

Odivelas World Championships Juniors Individuals 2023, 4-7 Oct 2023

Event Report

541 competitors from 67 nations

294 Men

247 Women



-60 kg	-66 kg	-73 kg	-81 kg	-90 kg	-100 kg	+100 kg	Men
49	43	49	52	45	29	27	294

-48 kg	-52 kg	-57 kg	-63 kg	-70 kg	-78 kg	+78 kg	Women
42	40	35	40	35	31	24	247

Continent	AJU	JUA	EJU	OJU	PJC	Total
Nations	6	13	35	2	11	67
Competitors	19	148	294	6	73	540

Schedule	Day 1	Day 2	Day 3	Day 4
Date	4 Oct	5 Oct	6 Oct	7 Oct
Start	09:00	10:00	10:30	11:00
Finals	16:00	16:00	16:00	16:00



-60 kg		
1	FUKUDA Yamato	JPN
2	IMRANOV Nizami	AZE
3	SAMY Youssry	EGY
3	ORYNBASSAR Talgat	KAZ
5	BEKMURODOV Zamohshari	UZB
5	CHAPURISHVILI Kako	GEO
7	BAKYTZHAN Aman	KAZ
7	ANDREYAN Ashik	ARM

-66 kg		
1	FUKUDA Yamato	JPN
2	FIKS Eran	ISR
3	RAKHMETKALI Zhanarys	KAZ
3	HADANO Keita	JPN
5	LIPARD Viljar	EST
5	ZIRAKASHVILI Tengo	GEO
7	DEMIREL Ibrahim	TUR
7	ZAIZAGALIYEV Nursultan	KAZ

-73 kg		
1	GALANDARZADE Vusal	AZE
2	YONEZUKA Jack	USA
3	SHEROV Abubakr	TJK
3	GAZALOEV Mouhammad	BEL
5	KIHARA Keito	JPN
5	ALMAT Adilet	KAZ
7	PREVE Eliot	FRA
7	DZITAC Ioan	ROU

-81 kg		
1	AMANO Kaito	JPN
2	LOLADZE Aleksandre	GEO
3	ARBUZOV Timur	AIN
3	IZAWA Naoto	JPN
5	MLADY Petr	CZE
5	RAJABLI Omar	AZE
7	KAIROLLA Zhalgas	KAZ
7	ZIYODULLAEV Akhror	UZB

-90 kg		
1	KAWABATA Komei	JPN
2	TALIBOV Vugar	AZE
3	DUINOVS Maksims	LAT
3	SANTAMARIA RODRIGUEZ Aharon	ESP
5	SAMANOV Alisher	UZB
5	CHOI Jaemin	KOR
7	VAN OOSTRUM Lars	NED
7	RADULJ Miljan	SRB

-100 kg		
1	ARAI Dota	JPN
2	SHORAKHMATOV Rustam	UZB
3	PAVLIUKOV Andzhei	AIN
3	SHELL Joes	NED
5	ABDURAKHMONOV Parviz	TJK
5	CARLETTI Jean	ITA
7	ALVAREZ RODRIGUEZ Jorge	ESP
7	MATASEJE Benjamin	SVK

+100 kg		
1	GURESHIDZE Shalva	GEO
2	TATAROGLU Ibrahim	TUR
3	ERTUG Munir	TUR
3	ANTONIOU Giannis	CYP
5	AHMADOV Ramazan	AZE
5	TERESINSKI Grzegorz	POL
7	ZHOLDOSHKAZIEV Emirkhan	KGZ
7	MESSE A BESSONG John Jr	CAN



-48 kg		
1	MIYAKI Kano	JPN
2	ERSIN Sila	TUR
3	AVANZATO Asia	ITA
3	DUDINA Kristina	AIN
5	GHIGLIONE Giulia	ITA
5	ALIYEVA Konul	AZE
7	FIELDER Anneliese	AUS
7	MYAGMARSUREN Nandin-Erdene	MGL

-52 kg		
1	KAMIYA Rin	JPN
2	CARNA Giulia	ITA
3	SCIACOVELLI Micaela	ITA
3	BERES Lea	FRA
5	CATANA Luciana	ROU
5	KLAUS-STERNWIESER Carina	AUT
7	LAVY Ruth	ISR
7	VEG Luca	HUN

-57 kg		
1	TONIOLO Veronica	ITA
2	HONDA Riko	JPN
3	BEURSKENS Julie	NED
3	COMANCHE Beatriz	BRA
5	SALONEN Pihla	FIN
5	RODRIGUEZ SALVADOR Adriana	ESP
7	HIDEN Verena	AUT
7	ABDIROVA Dana	KAZ

-63 kg		
1	AUCHECORNE Melkia	FRA
2	TAKAKI Mizuki	JPN
3	SIMIC Nina	CRO
3	GLUBIAK Martyna	POL
5	KRIZA Anna	HUN
5	YANG Jimin	KOR
7	SEIKKULA Louna-Lumia	FIN
7	FALGON Julie	FRA

-70 kg		
1	HONDA Mayu	JPN
2	CARDOSO Kaillany	BRA
3	DENGG Elena	AUT
3	SCHUSTER Kaja	SLO
5	FOHOOU April Lynn	SUI
5	NOVITZKI Adelina	ISR
7	BAR OR Gaya	ISR
7	CAKAREVIC Jovana	SRB

-78 kg		
1	KIM Minju	KOR
2	DERKS Lieke	NED
3	OLAYA Brenda	COL
3	BOUVIER Ilana	FRA
5	OTGONBAYAR Khuslen	MGL
5	BUDDENKOTTE Eva Ronja	GER
7	MICHAELIDOU Zanet	CYP
7	LUDEMA Berber	NED

+78 kg		
1	ARAI Mao	JPN
2	MUKUNOKI Miki	JPN
3	LEE Hyeonji	KOR
3	ALVES Katia	BRA
5	MISHINER Yuli Alma	ISR
5	MARINI Tiziana	ITA
7	SWEERS Paulien	NED
7	PIRES Enya	BRA



Medals

Odivelas World Championships Juniors Individuals 2023, 4-7 Oct 2023

Medals

Nations: 24

#	Nation	1. Place	2. Place	3. Place	5. Place	7. Place
1.	JPN Japan	9	3	2	1	
2.	AZE Azerbaijan	1	2		3	
3.	ITA Italy	1	1	2	3	
4.	GEO Georgia	1	1		2	
5.	FRA France	1		2		2
6.	KOR Republic of Korea	1		1	2	
7.	TUR Türkiye		2	1		1
8.	NED Netherlands		1	2		3
9.	BRA Brazil		1	2		1
10.	ISR Israel		1		2	2
11.	UZB Uzbekistan		1		2	1
12.	USA United States of America		1			
13.	KAZ Kazakhstan			2	1	4
14.	AUT Austria			1	1	1
14.	ESP Spain			1	1	1
16.	POL Poland			1	1	
16.	TJK Tajikistan			1	1	
18.	CYP Cyprus			1		1
19.	BEL Belgium			1		
19.	COL Colombia			1		
19.	CRO Croatia			1		
19.	EGY Egypt			1		
19.	LAT Latvia			1		
19.	SLO Slovenia			1		
25.	FIN Finland				1	1
25.	HUN Hungary				1	1
25.	MGL Mongolia				1	1
25.	ROU Romania				1	1
29.	CZE Czech Republic				1	
29.	EST Estonia				1	
29.	GER Germany				1	
29.	SUI Switzerland				1	
33.	SRB Serbia					2
34.	ARM Armenia					1
34.	AUS Australia					1
34.	CAN Canada					1
34.	KGZ Kyrgyzstan					1
34.	SVK Slovakia					1

Official person:



Statistics

Odivelas World Championships Juniors Individuals 2023, 4-7 Oct 2023

Statistics

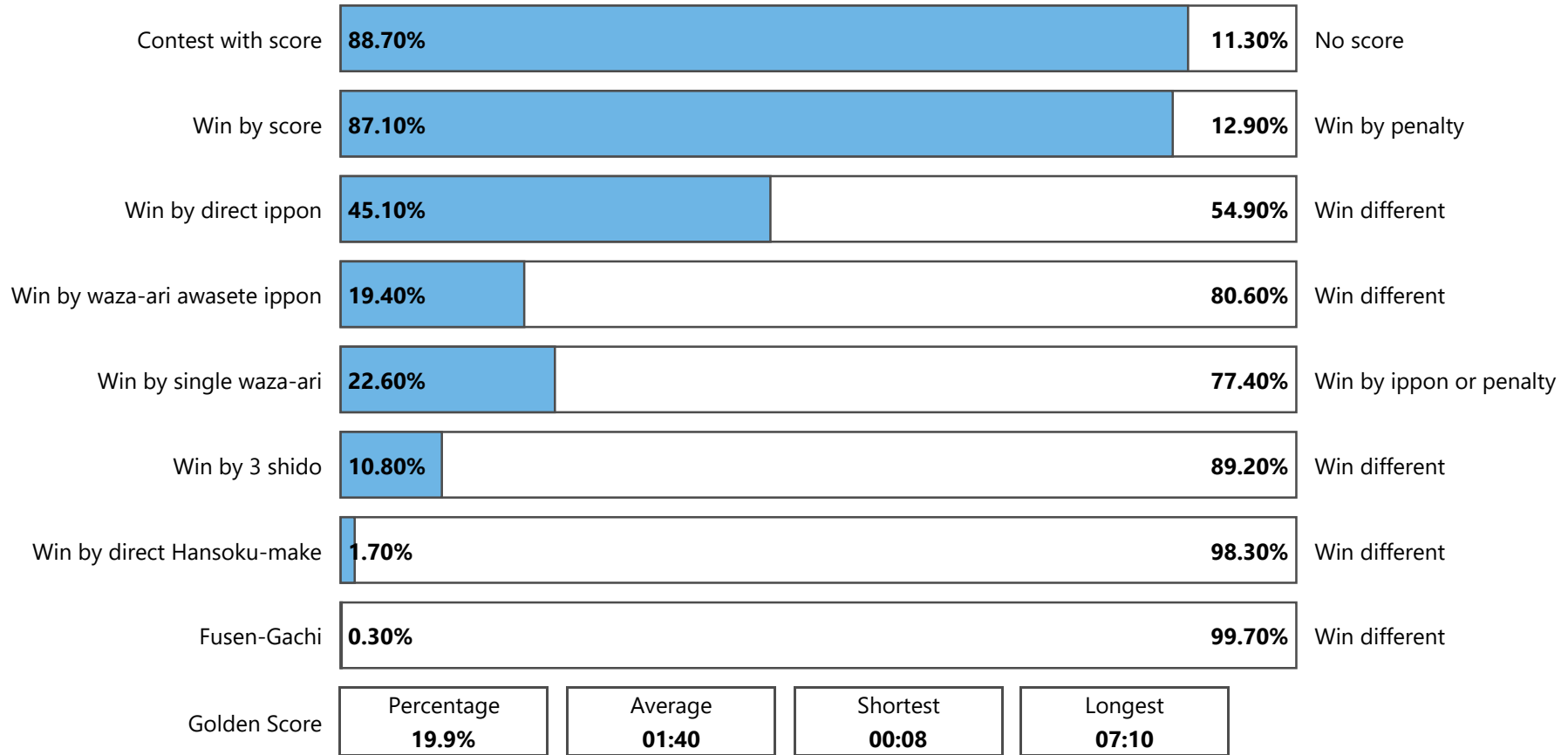



Statistics

Odivelas World Championships Juniors Individuals 2023, 4-7 Oct 2023

Statistics

	-60	-66	-73	-81	-90	-100	+100	M	-48	-52	-57	-63	-70	-78	+78	W	Total
Competitors	49	43	49	52	45	29	27	294	42	40	35	40	35	31	24	247	541
Contests	52	46	52	55	48	32	30	315	45	43	38	43	38	34	27	268	583
Contests with score	49	39	46	54	43	28	28	287	38	37	34	37	32	31	21	230	517
Contests with score %	94.2%	84.8%	88.5%	98.2%	89.6%	87.5%	93.3%	91.1%	84.4%	86%	89.5%	86%	84.2%	91.2%	77.8%	85.8%	88.7%
Wins by Score	48	38	46	54	43	27	28	284	38	37	33	36	31	29	20	224	508
Wins by Score %	92.3%	82.6%	88.5%	98.2%	89.6%	84.4%	93.3%	90.2%	84.4%	86%	86.8%	83.7%	81.6%	85.3%	74.1%	83.6%	87.1%
Wins by direct Ippon	24	18	22	30	24	14	16	148	22	20	17	16	14	14	12	115	263
Wins by direct Ippon %	46.2%	39.1%	42.3%	54.5%	50%	43.8%	53.3%	47.0%	48.9%	46.5%	44.7%	37.2%	36.8%	41.2%	44.4%	42.9%	45.1%
Wins by Waza-ari Awasete Ippon	9	4	10	14	10	8	4	59	7	9	8	9	9	6	6	54	113
Wins by Waza-ari Awasete Ippon %	17.3%	8.7%	19.2%	25.5%	20.8%	25%	13.3%	18.7%	15.6%	20.9%	21.1%	20.9%	23.7%	17.6%	22.2%	20.1%	19.4%
Wins by single Waza-ari	15	16	14	10	9	5	8	77	9	8	8	11	8	9	2	55	132
Wins by single Waza-ari %	28.8%	34.8%	26.9%	18.2%	18.8%	15.6%	26.7%	24.4%	20%	18.6%	21.1%	25.6%	21.1%	26.5%	7.4%	20.5%	22.6%
Wins by 3 Shido for opponent	3	8	5		4	3	2	25	4	5	4	7	6	5	7	38	63
Wins by 3 Shido for opponent %	5.8%	17.4%	9.6%	0%	8.3%	9.4%	6.7%	7.9%	8.9%	11.6%	10.5%	16.3%	15.8%	14.7%	25.9%	14.2%	10.8%
Direct Hansoku-make	1		1	1	1	2		6	1	1	1		1			4	10
Wins by direct Hansoku-make %	1.9%	0%	1.9%	1.8%	2.1%	6.3%	0%	1.9%	2.2%	2.3%	2.6%	0%	2.6%	0%	0%	1.5%	1.7%
Fusen-gachi									2							2	2
Fusen-gachi %	0%	0%	0%	0%	0%	0%	0%	0%	4.4%	0%	0%	0%	0%	0%	0%	0.7%	0.3%
All positive Scores (Waza-ari + direct Ippon)	64	47	66	81	62	43	36	399	52	52	48	53	45	39	29	318	717
Average Scores per contests	1.2	1	1.3	1.5	1.3	1.3	1.2	1.26	1.2	1.2	1.3	1.2	1.2	1.1	1.1	1.19	1.22
All penalties (Shido + HSK)	87	92	78	76	82	39	51	505	55	54	57	72	55	55	49	397	902
Average penalty per contest	1.7	2	1.5	1.4	1.7	1.2	1.7	1.6	1.2	1.3	1.5	1.7	1.4	1.6	1.8	1.5	1.55
Golden Score	12	13	13	7	12	2	5	64	9	9	8	11	7	6	2	52	116
Golden Score %	23.1%	28.3%	25%	12.7%	25%	6.3%	16.7%	20.3%	20%	20.9%	21.1%	25.6%	18.4%	17.6%	7.4%	19.4%	19.9%
Osae-komi																	
Osae-komi %	0%	0%	0%	0%	0%	0%	0%	0%	0%	0%	0%	0%	0%	0%	0%	0%	0%
Wins by Penalty	4	8	6	1	5	5	2	31	5	6	5	7	7	5	7	42	73



Nations Overview

Odivelas World Championships Juniors Individuals 2023, 4-7 Oct 2023

Nations

Overview

			-60	-66	-73	-81	-90	-100	+100	M	-48	-52	-57	-63	-70	-78	+78	W	Total	D		
1.		AIN	Individual Neutral Athletes		0	0	0	1	0	1	1	3	1	1	0	0	1	0	0	3	6	3
2.		ANG	Angola		2	0	0	0	0	0	0	2	2	0	0	0	0	0	0	2	4	2
3.		ARM	Armenia		2	1	1	0	0	0	0	4	0	0	0	0	0	0	0	0	4	1
4.		AUS	Australia		0	1	0	0	1	0	0	2	1	0	0	1	1	0	0	3	5	1
5.		AUT	Austria		1	0	0	1	0	0	0	2	0	1	1	0	1	0	0	3	5	3
6.		AZE	Azerbaijan		1	1	2	1	2	0	1	8	1	2	1	0	0	1	1	6	14	10
7.		BEL	Belgium		2	0	1	2	0	0	0	5	1	0	1	0	0	0	0	2	7	2
8.		BRA	Brazil		2	1	2	1	1	1	0	8	0	1	2	2	1	0	2	8	16	9
9.		BUL	Bulgaria		1	1	2	0	0	0	0	4	0	0	0	0	0	0	0	0	4	2
10.		CAN	Canada		0	0	1	1	0	0	1	3	2	1	1	0	1	0	0	5	8	2
11.		CHI	Chile		0	0	0	0	0	1	0	1	0	0	1	1	0	1	0	3	4	1
12.		CIV	Côte d'Ivoire		0	0	1	0	0	0	0	1	0	0	0	0	0	0	0	0	1	1
13.		COL	Colombia		2	2	1	1	1	0	0	7	0	0	0	0	0	1	0	1	8	3
14.		CRO	Croatia		0	0	0	2	0	0	0	2	0	0	0	1	1	0	1	3	5	4
15.		CYP	Cyprus		1	1	1	2	1	0	1	7	0	0	0	0	0	1	0	1	8	3
16.		CZE	Czech Republic		0	1	0	1	0	1	1	4	0	0	1	1	1	0	0	3	7	2
17.		DEN	Denmark		0	0	0	1	0	0	0	1	0	0	0	0	1	0	0	1	2	1
18.		DOM	Dominican Republic		0	0	0	0	0	0	0	0	0	0	0	1	0	0	0	1	1	0
19.		EGY	Egypt		1	0	1	1	1	0	0	4	0	0	0	1	0	1	1	3	7	3
20.		ESP	Spain		1	0	0	0	2	1	1	5	2	2	1	1	0	2	1	9	14	8
21.		EST	Estonia		0	1	0	0	2	0	0	3	0	0	1	0	1	0	0	2	5	3
22.		FIN	Finland		0	0	0	0	0	0	0	0	0	0	1	1	0	1	0	3	3	1
23.		FRA	France		2	1	1	1	1	2	1	9	1	2	1	2	0	2	1	9	18	9
24.		GBR	Great Britain		1	0	1	0	0	0	1	3	0	2	0	0	0	1	0	3	6	4
25.		GEO	Georgia		1	1	2	2	1	1	1	9	2	1	2	1	1	0	1	8	17	8
26.		GER	Germany		0	1	2	0	2	2	2	9	0	2	2	1	2	2	0	9	18	7
27.		GRE	Greece		0	2	2	2	1	0	1	8	1	1	0	2	2	1	0	7	15	4
28.		GUA	Guatemala		0	0	0	0	0	1	0	1	0	1	0	0	0	0	0	1	2	1
29.		HKG	Hong Kong, China		1	1	0	0	0	0	0	2	2	0	0	0	0	0	0	2	4	1
30.		HUN	Hungary		1	1	2	2	0	0	1	7	2	2	0	2	0	1	0	7	14	4
31.		IND	India		1	1	1	1	1	1	1	7	1	1	1	1	1	1	1	7	14	4
32.		ISR	Israel		2	2	1	1	1	0	0	7	0	1	0	0	2	0	1	4	11	3
33.		ITA	Italy		1	2	2	2	1	1	0	9	2	2	2	2	0	0	1	9	18	8
34.		JPN	Japan		1	2	1	2	1	1	1	9	1	1	1	1	1	2	2	9	18	11
35.		KAZ	Kazakhstan		2	2	1	2	1	0	1	9	2	1	1	1	1	2	1	9	18	16
36.		KGZ	Kyrgyzstan		0	2	2	2	0	0	1	7	0	0	0	0	0	0	0	0	7	2
37.		KOR	Republic of Korea		1	1	1	1	1	1	1	7	1	1	1	1	1	1	1	7	14	3
38.		KSA	Saudi Arabia		1	0	0	1	1	0	0	3	0	0	0	0	0	0	0	0	3	4
39.		LAT	Latvia		0	0	0	1	1	0	0	2	0	0	0	0	0	0	0	0	2	1
40.		LBN	Lebanon		0	0	0	0	0	0	0	0	0	0	0	1	0	0	0	1	1	1
41.		LTU	Lithuania		0	0	0	1	1	0	0	2	0	0	0	0	0	0	1	1	3	3
42.		MAD	Madagascar		0	0	1	0	0	0	0	1	0	0	0	0	1	0	0	1	2	1
43.		MAR	Morocco		0	0	1	0	0	0	0	1	1	0	1	1	0	0	0	3	4	1
44.		MDA	Republic of Moldova		1	0	2	1	1	0	0	5	1	0	0	0	0	0	0	1	6	1
45.		MEX	Mexico		1	2	1	1	1	0	0	6	0	1	1	1	0	0	1	4	10	1
46.		MGL	Mongolia		2	1	1	1	1	2	1	9	2	2	1	1	1	1	1	9	18	3



Nations Overview

Odivelas World Championships Juniors Individuals 2023, 4-7 Oct 2023

Nations

Overview

			-60	-66	-73	-81	-90	-100	+100	M	-48	-52	-57	-63	-70	-78	+78	W	Total	D	
47.		NED	Netherlands	0	0	0	1	1	1	0	3	0	0	1	1	0	2	1	5	8	8
48.		NOR	Norway	1	0	0	0	0	0	0	1	0	0	0	0	0	0	0	0	1	1
49.		NZL	New Zealand	0	1	0	0	0	0	0	1	0	0	0	0	0	0	0	0	1	1
50.		PAR	Paraguay	1	1	0	0	0	0	0	2	0	0	0	0	0	0	0	0	2	1
51.		POL	Poland	1	0	0	0	1	0	1	3	0	1	1	1	1	0	0	5	8	4
52.		POR	Portugal	3	2	2	1	3	1	0	12	2	0	1	4	1	1	1	10	22	15
53.		PUR	Puerto Rico	0	0	0	0	0	0	0	0	0	0	0	0	1	0	0	1	1	1
54.		ROU	Romania	1	1	1	0	2	1	1	7	2	1	0	0	0	0	1	4	11	8
55.		SLO	Slovenia	0	0	0	0	0	1	0	1	0	0	0	0	2	0	0	2	3	2
56.		SRB	Serbia	0	0	0	2	2	0	0	4	0	1	1	0	1	0	0	3	7	4
57.		SUI	Switzerland	0	0	0	0	0	0	0	0	0	1	0	1	1	0	0	3	3	1
58.		SVK	Slovakia	0	0	0	0	2	1	0	3	0	0	0	1	0	0	0	1	4	4
59.		SWE	Sweden	0	0	0	1	0	1	0	2	1	0	0	1	1	0	0	3	5	3
60.		TJK	Tajikistan	0	1	2	2	2	1	1	9	0	0	0	0	0	0	0	0	9	2
61.		TKM	Turkmenistan	2	2	1	0	1	1	0	7	2	2	2	1	0	0	0	7	14	4
62.		TPE	Chinese Taipei	1	0	1	1	0	1	0	4	2	1	1	0	0	2	0	6	10	3
63.		TUN	Tunisia	0	0	0	0	0	1	0	1	0	0	0	0	0	0	0	0	1	1
64.		TUR	Türkiye	1	1	0	1	0	0	2	5	2	0	1	0	1	0	1	5	10	5
65.		USA	United States of America	2	1	2	1	1	1	1	9	2	1	1	2	1	1	1	9	18	9
66.		UZB	Uzbekistan	1	1	1	2	2	1	1	9	0	2	1	1	2	2	1	9	18	6
67.		VEN	Venezuela	0	0	1	1	0	0	0	2	0	1	0	0	0	0	0	1	3	2
				49	43	49	52	45	29	26	293	42	40	35	40	35	31	24	247	540	251



Odivelas World Championships Juniors Individuals 2023

Portugal, Odivelas, 4-7 Oct 2023

-60 kg

Men (49)

POOL A

1	AUER Marcus (AUT)	33	WOLCZAK Y. (ISR)
2	WOLCZAK Y. (ISR)	00 s3 / 11 s0 [03:31]	
3	CHAPURISHVILI K. (GEO)	00 s0 / 11 s0 [02:05]	49
4	NYAMSUREN M. (MGL)	01 s1 / 00 s0 [04:00]	34
5	VELAZCO C. (USA)		
6	BARROSO LOPEZ L. (ESP)	00 s3 / 10 s0 [05:16]	35
7	MERDIN E. (BEL)	01 s1 / 00 s2 [06:18]	
8	SAMY Y. (EGY)	00 s0 / 02 s0 [01:19]	36

POOL B

9	IMRANOV N. (AZE)		
10	OH S. (KOR)	00 s2 / 02 s2 [03:42]	37
11	SAPAM M. (IND)	00 s0 / 10 s0 [00:59]	
12	GOMEZ J. (COL)	00 s1 / 10 s1 [02:04]	38
13	QUINTA J. (MEX)		
14	AGHASYAN V. (ARM)	02 s1 / 00 s2 [04:00]	39
15	BAKYTZHAN A. (KAZ)	10 s0 / 00 s1 [01:59]	
16	IGNASIAK K. (POL)	01 s2 / 00 s1 [04:30]	40

POOL C

17	AUGUSTO M. (BRA)		
18	FUKUDA Y. (JPN)	02 s0 / 00 s1 [01:01]	41
19	CHRISTODOULIDES P. (CYP)	00 s0 / 02 s1 [02:10]	
20	ANGHEL A. (ROU)	00 s0 / 10 s0 [01:25]	42
21	CABRAL M. (PAR)		
22	TUVSHINTUR T. (MGL)	00 s0 / 10 s1 [04:00]	43
23	ORYNBASSAR T. (KAZ)	00 s0 / 01 s1 [04:00]	
24	HRISTOV H. (BUL)	10 s0 / 00 s0 [00:24]	44

POOL D

25	BARROS L. (ANG)		
26	FARKAS B. (HUN)	00 s0 / 10 s0 [00:28]	45
27	ROVIRA J. (POR)	01 s2 / 00 s0 [04:00]	
28	ANDREYAN A. (ARM)	00 s1 / 10 s1 [01:39]	46
29	VEKSLER Y. (ISR)		
30	GUSTIUC C. (MDA)	00 s2 / 01 s1 [04:49]	47
31	BEKMURODOV Z. (UZB)	02 s0 / 00 s1 [01:50]	
32	AGAMAMMEDOV A. (TKM)	00 s1 / 01 s2 [04:00]	48

REPECHAGE

61	SAMY Y. (EGY)	01 s2 / 00 s2 [04:37]	
62	ORYNBASSAR T. (KAZ)	11 s1 / 00 s0 [03:49]	
65	SAMY Y. (EGY)	01 s2 / 00 s1 [07:44]	
66	ORYNBASSAR T. (KAZ)	11 s0 / 00 s0 [01:27]	

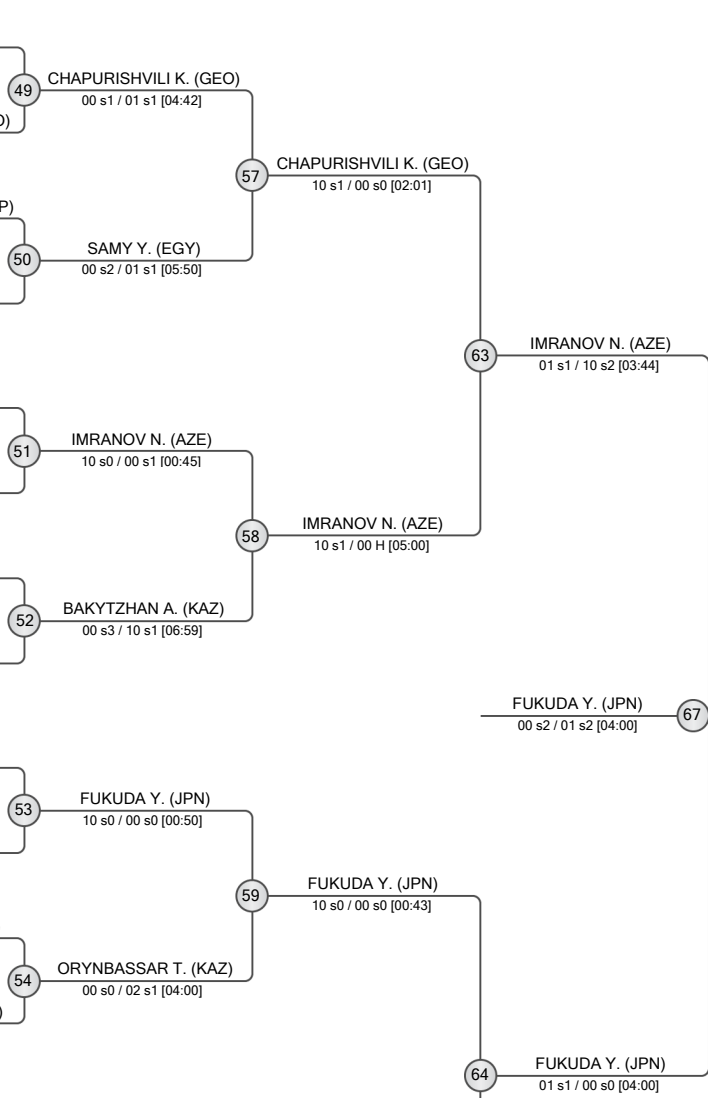

FINAL RESULTS	
1.	FUKUDA Yamato (JPN)
2.	IMRANOV Nizami (AZE)
3.	SAMY Youssry (EGY)
3.	ORYNBASSAR Talgat (KAZ)
5.	BEKMURODOV Zamohshari (UZB)
5.	CHAPURISHVILI Kako (GEO)
7.	BAKYTZHAN Aman (KAZ)
7.	ANDREYAN Ashik (ARM)





Odivelas World Championships Juniors Individuals 2023

Portugal, Odivelas, 4-7 Oct 2023

-66 kg

Men (43)

POOL A

	GREENBANK Jordon	AUS
	VILLADA Santiago	COL
	FUKUDA Yamato	JPN
	LUNGU Flavius	ROU
	DE LUCA Alessio	ITA
	RAKHMETKALI Zhanarys	KAZ
	KALAITSIDIS Georgios	CYP
	LIMA Ronald	BRA
	YOTOV Boyan	BUL
	MICHAILIDIS Alexios	GRE

1	GREENBANK J. (AUS)
2	VILLADA S. (COL)
3	FUKUDA Y. (JPN)
4	DE LUCA A. (ITA)
5	RAKHMETKALI Z. (KAZ)
6	LIMA R. (BRA)
7	YOTOV B. (BUL)
8	MICHAILIDIS A. (GRE)

POOL B

	ZIRAKASHVILI Tengo	GEO
	SADRIDDINZODA Fazliddin	TKM
	JUGDERGARAV Enkhtur	MGL
	RAHIMOV Serdar	TKM
	CHYNYBEKOV Kazybek	KGZ
	ICELO Jose	MEX
	SORKIN Robert	ISR
	DEMIREL Ibrahim	TUR
	LAM Chak Hin	HKG
	KIM Chanwook	KOR
	GAGO Miguel	POR

9	ZIRAKASHVILI T. (GEO)
10	JUGDERGARAV E. (MGL)
11	RAHIMOV S. (TKM)
12	CHYNYBEKOV K. (KGZ)
13	ICELO J. (MEX)
14	DEMIREL I. (TUR)
15	LAM Chak Hin
16	GAGO M. (POR)

POOL C

	VICENTINI Marcelo	PAR
	NOEL Kylian	FRA
	PAYNE Dylan	NZL
	HADANO Keita	JPN
	SANCHEZ GARNICA Keiner	COL
	RZAYEV Aydin	AZE
	MYRADOV Toyly	TKM
	ACCOGLI Valerio	ITA
	MUKHAMMADJONOV Mukhammadyakhyo	UZB
	SCHMIDT Noel	GER
	LIPARD Viljar	EST

17	VICENTINI M. (PAR)
18	NOEL K. (FRA)
19	HADANO K. (JPN)
20	SANCHEZ GARNICA K. (COL)
21	RZAYEV A. (AZE)
22	ACCOGLI V. (ITA)
23	MUKHAMMADJONOV M. (UZB)
24	LIPARD V. (EST)

POOL D

	FIKS Eran	ISR
	MAJGUL Rohit Basir	IND
	FERNANDES B. Tralhao	POR
	DVORACEK Antonin	CZE
	ANASTASOPOULOS Adam	GRE
	ZAIZAGALIYEV Nursultan	KAZ
	GABOR Aron	HUN
	CUEVAS Elias	MEX
	ABASBEKOV Erbol	KGZ
	NIKOYAN Mesrop	ARM
	BAKHTIYOR Amin	USA

25	FIKS E. (ISR)
26	MAJGUL R. (IND)
27	DVORACEK A. (CZE)
28	ANASTASOPOULOS A. (GRE)
29	ZAIZAGALIYEV N. (KAZ)
30	CUEVAS E. (MEX)
31	ABASBEKOV E. (KGZ)
32	BAKHTIYOR A. (USA)

REPECHAGE

61	RAKHMETKALI Z. (KAZ)
62	HADANO K. (JPN)

63	FUKUDA Y. (JPN)
64	FIKS E. (ISR)
65	RAKHMETKALI Z. (KAZ)
66	HADANO K. (JPN)
67	FUKUDA Y. (JPN)

FINAL RESULTS		
1.	FUKUDA Yamato	JPN
2.	FIKS Eran	ISR
3.	RAKHMETKALI Zhanarys	KAZ
3.	HADANO Keita	JPN
5.	LIPARD Viljar	EST
7.	ZIRAKASHVILI Tengo	GEO
7.	DEMIREL Ibrahim	TUR
7.	ZAIZAGALIYEV Nursultan	KAZ





Odivelas World Championships Juniors Individuals 2023

Portugal, Odivelas, 4-7 Oct 2023

-73 kg

Men (49)

POOL A

1	FALCAO Gabriel (BRA)	33	SHEROV A. (TJK)
2	KOROTICH Ruslan (USA)	00 s1 / 02 s0 [01:42]	01 s0 / 10 s1 [02:52]
3	SHEROV Abubakr (TJK)	ADORJANI G. (HUN)	ADORJANI G. (HUN)
4	ADORJANI Gergely (HUN)	01 s2 / 00 s1 [04:00]	11 s0 / 00 s2 [02:12]
5	DREXLER Philip (GER)	TOSHEV K. (UZB)	ABOHASHIM A. (EGY)
6	TOSHEV Khojiakbar (UZB)	ABOHASHIM A. (EGY)	CHEN C. (TPE)
7	ABOHASHIM Ammar (EGY)	CHEN C. (TPE)	01 s0 / 10 s0 [01:10]
8	DIMITRIADI Christos (CYP)	CHEN C. (TPE)	00 s0 / 10 s0 [00:35]
9	CHEN Chen-Hsin (TPE)	ALMAT A. (KAZ)	ALMAT A. (KAZ)
10	GIANNOPOULOS Dimitrios (GRE)	ALMAT A. (KAZ)	00 s2 / 10 s0 [03:30]
11	ALMAT Adilet (KAZ)	ZELMAN J. (CIV)	ALMAT A. (KAZ)
12	ZELMAN Jerome Assafoua (CIV)	ZELMAN J. (CIV)	10 s0 / 00 s1 [01:17]

POOL B

9	GALANDARZADE Vusal (AZE)	37	GALANDARZADE V. (AZE)
10	ESPOSITO Fabrizio (ITA)	ESPOSITO F. (ITA)	10 s2 / 00 s3 [03:30]
11	GOSPODINOV Dimitar (BUL)	LOLADZE G. (GEO)	LOLADZE G. (GEO)
12	LAHMOURI Noh (MAR)	LOLADZE G. (GEO)	00 s0 / 10 s0 [01:01]
13	LOLADZE Giorgi (GEO)	ALTAIBAATAR U. (MGL)	ALTAIBAATAR U. (MGL)
14	ALTAIBAATAR Usukhjargal (MGL)	ALTAIBAATAR U. (MGL)	11 s0 / 01 s0 [02:59]
15	TSATSALASHVILI Lasha (CAN)	TSATSALASHVILI L. (CAN)	PREVE E. (FRA)
16	BAKIRDINOV Nurmukhammed (KGZ)	PREVE E. (FRA)	00 s1 / 01 s1 [04:15]
17	PREVE Eliot (FRA)	SOLTANOV B. (TKM)	SOLTANOV B. (TKM)
18	BIBITKO Itay (ISR)	SOLTANOV B. (TKM)	00 s1 / 10 s0 [04:17]
19	SOLTANOV Begench (TKM)	MITRU V. (MDA)	MITRU V. (MDA)
20	KVANTIDZE Otari (POR)	MITRU V. (MDA)	00 s1 / 10 s0 [01:20]
21	MITRU Vlad (MDA)	MITRU V. (MDA)	01 s0 / 11 s1 [05:13]

POOL C

17	TERASHVILI Giorgi (GEO)	41	TERASHVILI G. (GEO)
18	ALIYEV Suleyman (AZE)	ALIYEV S. (AZE)	10 s2 / 00 s3 [04:41]
19	LAISHRAM Max Meetei (IND)	DZITAC I. (ROU)	DZITAC I. (ROU)
20	DZITAC Ioan (ROU)	DZITAC I. (ROU)	02 s0 / 01 s0 [01:45]
21	MAERKT Levi (GER)	KIM E. (KOR)	KIM E. (KOR)
22	KIM Eojin (KOR)	DAVIES L. (GBR)	DAVIES L. (GBR)
23	DAVIES Luke (GBR)	DAVIES L. (GBR)	01 s0 / 00 s0 [05:12]
24	PERDOMO David (VEN)	GOMES T. (POR)	GOMES T. (POR)
25	GOMES Tomas (POR)	GOMES T. (POR)	00 s0 / 02 s0 [01:05]
26	KOTZACHRISTOS Georgios (GRE)	KIHARA K. (JPN)	KIHARA K. (JPN)
27	KIHARA Keito (JPN)	KIHARA K. (JPN)	00 s0 / 10 s0 [00:47]
28	LEONTOAE Grigori (MDA)	LEONTOAE G. (MDA)	LEONTOAE G. (MDA)
29	LEONTOAE G. (MDA)	LEONTOAE G. (MDA)	01 s1 / 00 s1 [04:00]

POOL D

25	YONEZUKA Jack (USA)	45	YONEZUKA J. (USA)
26	ARDINA Vinicius (BRA)	ARDINA V. (BRA)	01 s1 / 00 s0 [04:00]
27	POKK Armand (HUN)	ASADULLOEVI M. (TJK)	ASADULLOEVI M. (TJK)
28	ASADULLOEVI Muhiddin (TJK)	ASADULLOEVI M. (TJK)	01 s1 / 00 s1 [04:00]
29	ALIEV Abdulla (KGZ)	GUERRA R. (MEX)	GUERRA R. (MEX)
30	GUERRA Ricardo (MEX)	GUERRA R. (MEX)	10 s0 / 00 s0 [00:44]
31	PELLIGRA Vincenzo (ITA)	PELLIGRA V. (ITA)	PELLIGRA V. (ITA)
32	PALEV Mariyan (BUL)	PELLIGRA V. (ITA)	01 s2 / 00 s1 [04:00]
33	RANDRIANASOLO Lova Mahaisoa (MAD)	GAZALOEVI M. (BEL)	GAZALOEVI M. (BEL)
34	TOROSYAN Artak (ARM)	GAZALOEVI M. (BEL)	00 s0 / 10 s0 [00:22]
35	GAZALOEVI Mouhammad (BEL)	RUIZ MESA F. (COL)	RUIZ MESA F. (COL)
36	RUIZ MESA Ferney (COL)	RUIZ MESA F. (COL)	01 s0 / 00 s2 [04:12]

REPECHAGE

61	SHEROV A. (TJK)	65	SHEROV A. (TJK)
62	PREVE E. (FRA)	65	SHEROV A. (TJK)
63	KIHARA K. (JPN)	65	SHEROV A. (TJK)
64	DZITAC I. (ROU)	65	SHEROV A. (TJK)
65	GAZALOEVI M. (BEL)	66	GAZALOEVI M. (BEL)
66	GAZALOEVI M. (BEL)	66	GAZALOEVI M. (BEL)
67	ALMAT A. (KAZ)	66	GAZALOEVI M. (BEL)

57	ALMAT A. (KAZ)	63	GALANDARZADE V. (AZE)
58	ALMAT A. (KAZ)	63	GALANDARZADE V. (AZE)
59	PREVE E. (FRA)	63	GALANDARZADE V. (AZE)
60	PREVE E. (FRA)	63	GALANDARZADE V. (AZE)
61	KIHARA K. (JPN)	67	GALANDARZADE V. (AZE)
62	KIHARA K. (JPN)	67	GALANDARZADE V. (AZE)
63	YONEZUKA J. (USA)	67	GALANDARZADE V. (AZE)
64	YONEZUKA J. (USA)	67	GALANDARZADE V. (AZE)

FINAL RESULTS

- GALANDARZADE Vusal (AZE)
- YONEZUKA Jack (USA)
- SHEROV Abubakr (TJK)
- GAZALOEVI Mouhammad (BEL)
- KIHARA Keito (JPN)
- ALMAT Adilet (KAZ)
- PREVE Eliot (FRA)
- DZITAC Ioan (ROU)





Odivelas World Championships Juniors Individuals 2023

Portugal, Odivelas, 4-7 Oct 2023

-81 kg

Men (52)

POOL A

1	MADDALONI NOSA Bright	ITA	1	MADDALONI NOSA B. (ITA)	33	MADDALONI NOSA B. (ITA)	11 s0 / 00 s2 [04:00]	
2	ALMEIDA Filipe	POR	2	ASKHAM D. (DEN)	00 s1 / 10 s0 [01:58]	49	IZAWA N. (JPN)	00 s1 / 02 s0 [03:06]
3	ASKHAM Djoni	DEN	3	SAYFIDINZODA S. (TJK)	00 s1 / 01 s0 [04:10]	34	IZAWA N. (JPN)	00 s0 / 10 s0 [01:08]
4	KESOV Petros	CYP	4	IZAWA N. (JPN)	00 s0 / 11 s0 [01:57]	57	IZAWA N. (JPN)	02 s0 / 00 s1 [02:40]
5	SAYFIDINZODA Sayfidin	TJK	5	BELLINI A. (ITA)		50	KAIROLLA Z. (KAZ)	00 s2 / 11 s1 [03:09]
6	GURGEN Erman	TUR	6	GRIBINET C. (MDA)	01 s0 / 02 s2 [04:37]	35	GRIBINET C. (MDA)	01 s0 / 02 s2 [04:37]
7	IZAWA Naoto	JPN	7	KAIROLLA Z. (KAZ)	11 s0 / 00 s1 [02:47]	36	KAIROLLA Z. (KAZ)	10 s1 / 00 s0 [01:36]
8	BELLINI Alessandro	ITA	8	CHRISTIAENS N. (BEL)				

POOL B

9	ABDELAAL Aly	EGY	9	ABDELAAL A. (EGY)	37	DE LANGE J. (NED)	00 s0 / 01 s2 [04:00]	
10	RAMIREZ Jose	MEX	10	DE LANGE J. (NED)	00 s0 / 02 s0 [01:03]	51	MLADY P. (CZE)	01 s2 / 10 s1 [02:11]
11	DE LANGE Joshua	NED	11	MLADY P. (CZE)	00 s2 / 02 s2 [06:26]	38	MLADY P. (CZE)	01 s2 / 00 s0 [05:35]
12	ALMAZJAN UULU Tegin	KGZ	12	SHARIPOV S. (UZB)	00 s0 / 02 s0 [00:33]	39	DOS SANTOS K. (BRA)	01 s1 / 00 s0 [04:00]
13	MLADY Petr	CZE	13	DOS SANTOS K. (BRA)	11 s0 / 00 s1 [01:59]	52	LOLADZE A. (GEO)	00 s2 / 01 s2 [04:00]
14	KAPSOUROS Marios	GRE	14	STANIMIROVIC V. (SRB)	01 s1 / 00 s0 [04:00]	40	LOLADZE A. (GEO)	00 s0 / 10 s0 [00:21]
15	SHARIPOV Shakhzodkhuja	UZB	15	SILOT J. (USA)	01 s1 / 00 s0 [04:00]			
16	DOS SANTOS Kauan	BRA	16	LOLADZE A. (GEO)				

POOL C

17	MELADZE Jumber	CAN	17	MELADZE J. (CAN)	41	MELADZE J. (CAN)	11 s0 / 00 s2 [01:41]	
18	SUN Li-Wei	TPE	18	AGRONOV Y. (ISR)	00 s0 / 10 s0 [00:25]	53	ARBUZOV T. (AIN)	00 s1 / 01 s0 [04:52]
19	AGRONOV Yaniv	ISR	19	CAPAN B. (CRO)	02 s2 / 00 s2 [03:34]	42	ARBUZOV T. (AIN)	00 s0 / 10 s0 [01:05]
20	CAPAN Bruno	CRO	20	ARBUIZOV T. (AIN)	01 s1 / 11 s2 [01:59]	59	ARBUZOV T. (AIN)	02 s1 / 00 s1 [01:49]
21	NERGUI Jangarai	MGL	21	BABUTSIDZE L. (GEO)		54	ZIYODULLAEV A. (UZB)	01 s2 / 00 s1 [04:00]
22	GIORDANO Matteo	FRA	22	ZIYODULLAEV A. (UZB)	00 s2 / 10 s0 [03:05]	43	ZIYODULLAEV A. (UZB)	00 s0 / 10 s0 [00:18]
23	ARBUIZOV Timur	AIN	23	ABDUJALILZODA M. (TJK)	10 s0 / 00 s0 [03:11]	44	ABDUJALILZODA M. (TJK)	02 s1 / 00 s1 [03:58]
24	BABUTSIDZE Luka	GEO	24	MIHALOVS I. (LAT)				

POOL D

25	MAXIM Meiirlan	KAZ	25	MAXIM M. (KAZ)	45	AMANO K. (JPN)	00 H / 10 s0 [01:39]	
26	ALHAJRI Mohammed	KSA	26	AMANO K. (JPN)	00 s0 / 10 s1 [00:41]	55	AMANO K. (JPN)	02 s0 / 00 s1 [03:18]
27	AMANO Kaito	JPN	27	Perez RUIZ John	00 s0 / 10 s0 [01:22]	46	KIM S. (KOR)	10 s2 / 00 s1 [04:38]
28	PEREZ RUIZ John	COL	28	MILANOV D. (SRB)		60	AMANO K. (JPN)	10 s1 / 00 s0 [03:04]
29	KIM Seungmin	KOR	29	FASCHING B. (AUT)	47	FASCHING B. (AUT)	11 s0 / 01 s2 [05:38]	
30	MILANOV Djordje	SRB	30	PATETE J. (VEN)	10 s0 / 00 s1 [01:11]	56	RAJABLI O. (AZE)	00 s0 / 02 s0 [01:46]
31	FASCHING Bernd	AUT	31	KANATBEKOV E. (KGZ)	10 s0 / 00 s1 [01:04]	48	RAJABLI O. (AZE)	00 s0 / 10 s0 [00:39]
32	PATETE Jonhelius	VEN	32	RAJABLI O. (AZE)	00 s1 / 11 s0 [03:14]			

REPECHAGE

61	MLADY P. (CZE)	00 s0 / 10 s0 [00:20]	65	ARBUZOV T. (AIN)	00 s2 / 10 s1 [02:35]
62	RAJABLI O. (AZE)	00 s1 / 10 s1 [03:59]	66	IZAWA N. (JPN)	00 s0 / 02 s0 [01:51]

AMANO K. (JPN) 67
00 s1 / 10 s0 [02:47]

FINAL RESULTS

1. AMANO Kaito JPN
2. LOLADZE Aleksandre GEO
3. ARBUZOV Timur AIN
5. MLADY Petr CZE
7. RAJABLI Omar AZE





Odivelas World Championships Juniors Individuals 2023

Portugal, Odivelas, 4-7 Oct 2023

-90 kg

Men (45)

POOL A

TALIBOV Vugar	AZE	1	TALIBOV V. (AZE)
ARSENIE Rares	ROU	2	ARSENIE R. (ROU)
RAJABOV Umedjon	TJK	3	RAJABOV U. (TJK)
QUIROZ GARCIA Emmanuel	COL	4	QUIROZ G. (COL)
LIMA Pedro	POR	5	LIMA P. (POR)
DUINOV M Maksims	LAT	6	DUINOV M. (LAT)
OLIVARES Jeremy	MEX	7	OLIVARES J. (MEX)
MARUSKA Alex	SVK	8	MARUSKA A. (SVK)
KAZANTZOPOULOS Konstantinos Nikiforos	GRE	9	KAZANTZOPOULOS K. (GRE)
NYZHNYK Oleksandr	USA	10	NYZHNYK O. (USA)
ALHAJRI Saud	KSA	11	ALHAJRI S. (KSA)

POOL B

VAN OOSTRUM Lars	NED	9	VAN OOSTRUM L. (NED)
TSERENDULAM Dagvadorj	MGL	10	TSERENDULAM D. (MGL)
ACHYLDYEV Mamedaly	TKM	11	ACHYLDYEV M. (TKM)
ROOSTFELDT Patrik	EST	12	ROOSTFELDT P. (EST)
TANGRIEV Mukhammadali	UZB	13	TANGRIEV M. (UZB)
FAVA Tommaso	ITA	14	FAVA T. (ITA)
NINGTHOUJAM Sheetal Singh	IND	15	NINGTHOUJAM S. (IND)
SANTAMARIA RODRIGUEZ Aharon	ESP	16	SANTAMARIA RODRIGUEZ A. (ESP)
KOBERIDZE Tamaz	GEO	17	KOBERIDZE T. (GEO)
PACARIZ Armin	GER	18	PACARIZ A. (GER)
GHIMBOVSCHI Vadim	MDA	19	GHIMBOVSCHI V. (MDA)

POOL C

ELRAMLY Omar	EGY	17	ELRAMLY O. (EGY)
KARATSAOUSIDIS Theocharis	CYP	18	KARATSAOUSIDIS T. (CYP)
LUIS Diogo	POR	19	LUIS D. (POR)
WASIKOWSKI Michal	POL	20	WASIKOWSKI M. (POL)
SAMANOV Alisher	UZB	21	SAMANOV A. (UZB)
BULAJA Milan	SRB	22	BULAJA M. (SRB)
SCHRIEVER Lasse	GER	23	SCHRIEVER L. (GER)
CHOI Jaemin	KOR	24	CHOI J. (KOR)
SCHEFFEL Oliver	SVK	25	SCHEFFEL O. (SVK)
SIBISAN Alexandru	ROU	26	SIBISAN A. (ROU)
GABAY Inbar	ISR	27	GABAY I. (ISR)

POOL D

RADULJ Miljan	SRB	25	RADULJ M. (SRB)
JANDIERI Zaza	ESP	26	JANDIERI Z. (ESP)
DOSSYMOV Kudyret	KAZ	27	DOSSYMOV K. (KAZ)
VOJNIKOVICH Danny	AUS	28	VOJNIKOVICH D. (AUS)
ZAMANOV Ismayil	AZE	29	ZAMANOV I. (AZE)
SLYTERIS Augustas	LTU	30	SLYTERIS A. (LTU)
MILANO Gustavo	BRA	31	MILANO G. (BRA)
KISHVAROV Somoni	TJK	32	KISHVAROV S. (TJK)
REIMETS Georg	EST	33	REIMETS G. (EST)
CHANTRE Diogo	POR	34	CHANTRE D. (POR)
CUREAU Baptiste	FRA	35	CUREAU B. (FRA)
KAWABATA Komei	JPN	36	KAWABATA K. (JPN)

REPECHAGE

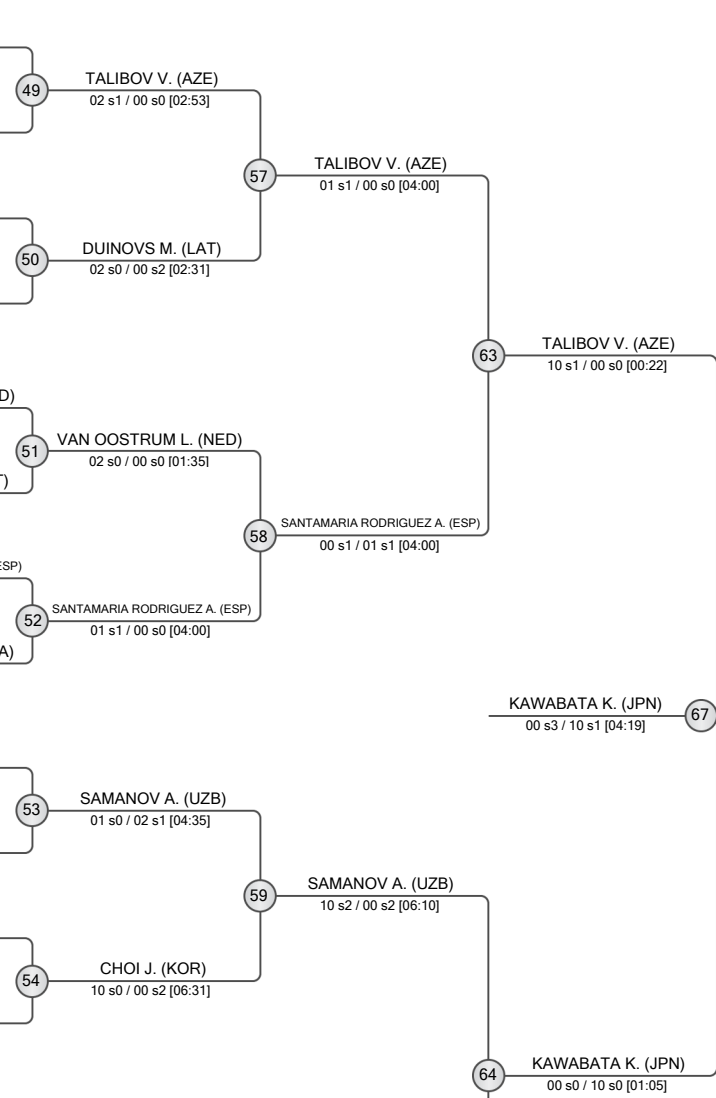
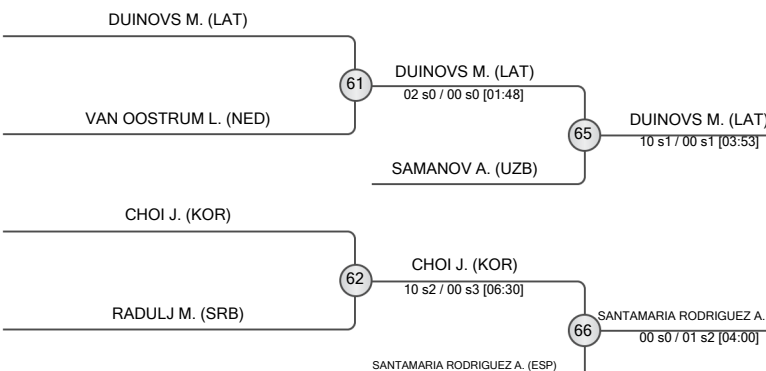

FINAL RESULTS

1.	KAWABATA Komei	JPN
2.	TALIBOV Vugar	AZE
3.	DUINOV M Maksims	LAT
3.	SANTAMARIA RODRIGUEZ Aharon	ESP
5.	SAMANOV Alisher	UZB
5.	CHOI Jaemin	KOR
7.	VAN OOSTRUM Lars	NED
7.	RADULJ Miljan	SRB





Odivelas World Championships Juniors Individuals 2023

Portugal, Odivelas, 4-7 Oct 2023

-100 kg

Men (29)

POOL A

	ANGLIONIN Mathias	FRA
	PEREZ William	GUA
	PAVLIUKOV Andzhei	AIN
	SHORAKHMATOV Rustam	UZB
	ARISMENDI Franco	CHI
	BAYARTSENGEL Khuderchuluun	MGL
	BEN GHARES Koussay	TUN

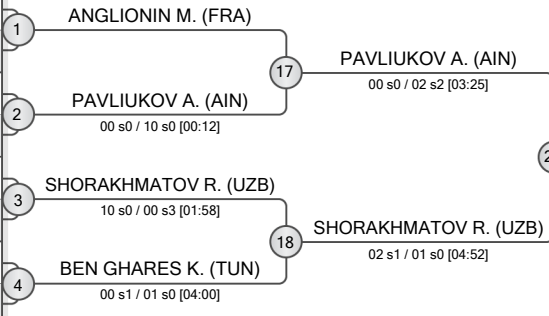

POOL B

	CARLETTI Jean	ITA
	MAJANOV Baymyrat	TKM
	VISHAL Vishal	IND
	UDSILAURI George	GER
	BORDIN Maxence	FRA
	ALVAREZ RODRIGUEZ Jorge	ESP
	CAUSSE Jared	USA
	SILVA Guilherme	POR

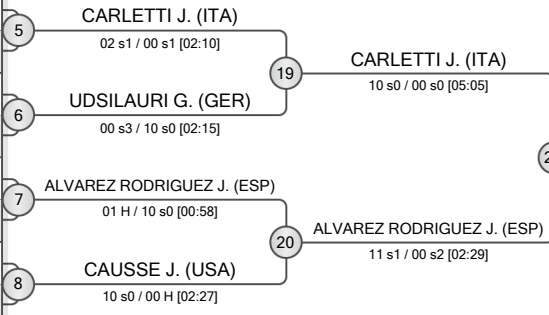

POOL C

	MATASEJE Benjamin	SVK
	BERTALANIC ZIZEK Gal	SLO
	GANTULGA Khangarid	MGL
	DUDY David	CZE
	GUIMARAES Matheus	BRA
	ABDURAKHMONOV Parviz	TJK
	BAEK Sungmin	KOR

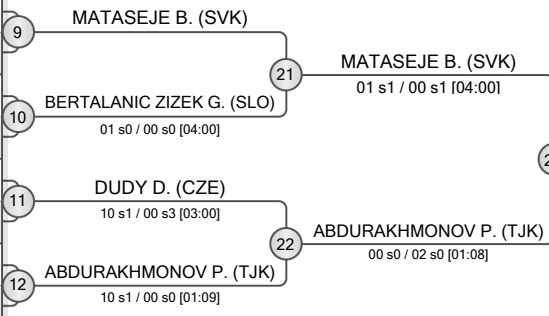

POOL D

	KAPPELMEIER Kilian	GER
	TSAI Chieh-En	TPE
	SCHELL Joes	NED
	PETRE Bogdan	ROU
	ROSWALL Lukas	SWE
	ARAI Dota	JPN
	BADUASHVILI Giorgi	GEO

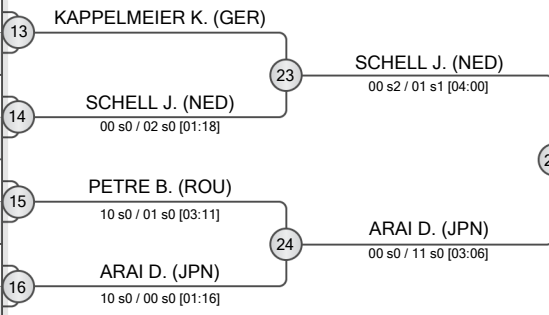

REPECHAGE

PAVLIUKOV A. (AIN)	29 PAVLIUKOV A. (AIN)
ALVAREZ RODRIGUEZ J. (ESP)	30 SCHELL J. (NED)
MATASEJE B. (SVK)	31 SCHELL J. (NED)
SCHELL J. (NED)	32 CARLETTI J. (ITA)

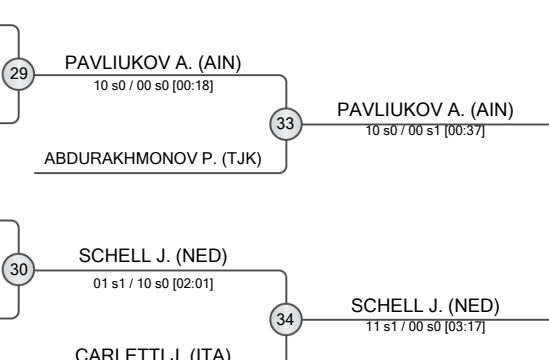

FINAL RESULTS		
1.	ARAI Dota	JPN
2.	SHORAKHMATOV Rustam	UZB
3.	PAVLIUKOV Andzhei	AIN
3.	SCHELL Joes	NED
5.	ABDURAKHMONOV Parviz	TJK
5.	CARLETTI Jean	ITA
7.	ALVAREZ RODRIGUEZ Jorge	ESP
7.	MATASEJE Benjamin	SVK





Odivelas World Championships Juniors Individuals 2023

Portugal, Odivelas, 4-7 Oct 2023

+100 kg

Men (27)

POOL A

	GURESHIDZE Shalva	GEO
	UDSILAURO Daniel	GER
	AKIANA MONGO Matheo	FRA
	KEVLISHVILI Davit	ESP
	DOBOS Levente	HUN
	ERTUG Munir	TUR
	FUJIMOTO Io	JPN

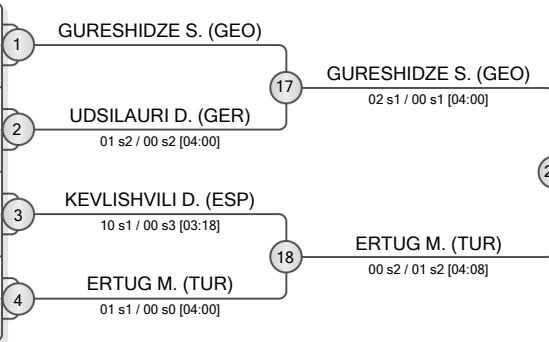

POOL B

	ANTONIOU Giannis	CYP
	MAKHSUDOV Makhmudjon	UZB
	KOSTELIDIS Ioannis	GRE
	RASKA Tomas	CZE
	ZHOLDOSHKAZIEV Emirkhan	KGZ
	KHOKHLOV Christian	IJF

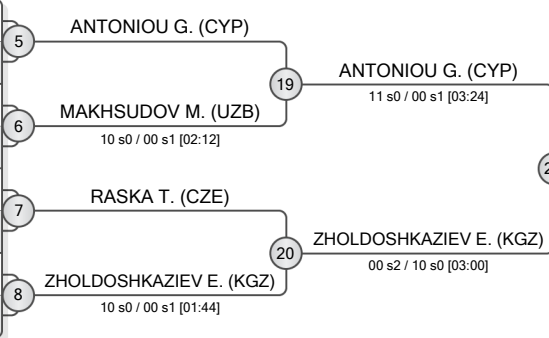

POOL C

	MESSE A BESSONG John Jr	CAN
	SEMENENKO Alex	USA
	BATCHAEV Denis	AIN
	GHANGAS Yash	IND
	EDE Daniel	GBR
	TATAROGLU Ibrahim	TUR
	LUTAA Enkhbold	MGL

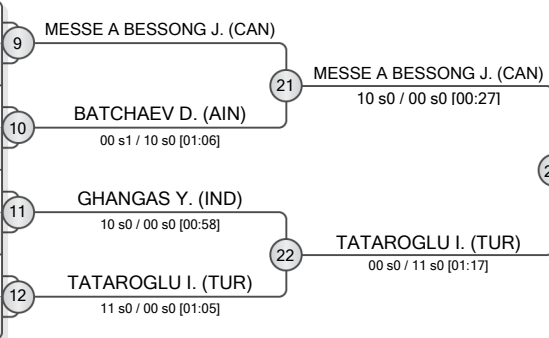

POOL D

	TERESINSKI Grzegorz	POL
	JANG Yumin	KOR
	KABLAN Nursultan	KAZ
	GEORGESCU Darius	ROU
	NIKITENKO Nikita	GER
	AHMADOV Ramazan	AZE
	ELMURODOV Ibrohimjon	TJK

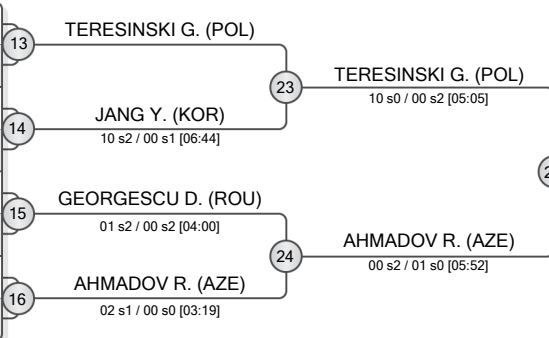

REPECHAGE

ERTUG M. (TUR)	
ZHOLDOSHKAZIEV E. (KGZ)	
MESSE A BESSONG J. (CAN)	
TERESINSKI G. (POL)	

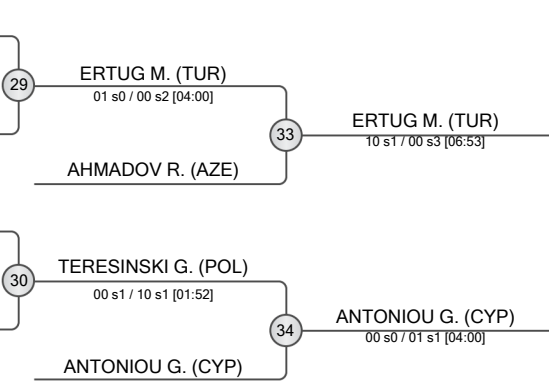

GURESHIDZE S. (GEO) 35
02 s0 / 00 s1 [01:50]

TATAROGLU I. (TUR) 32
11 s0 / 00 s1 [02:46]

FINAL RESULTS	
1. GURESHIDZE Shalva	GEO
2. TATAROGLU Ibrahim	TUR
3. ERTUG Munir	TUR
5. ANTONIOU Giannis	CYP
5. AHMADOV Ramazan	AZE
5. TERESINSKI Grzegorz	POL
7. ZHOLDOSHKAZIEV Emirkhan	KGZ
7. MESSE A BESSONG John Jr	CAN





Odivelas World Championships Juniors Individuals 2023

Portugal, Odivelas, 4-7 Oct 2023

-48 kg

Women (42)

POOL A

1	AZAK Merve (TUR)	33	AZAK M. (TUR)
2	ENKHJARGAL Khuslen (MGL)	01 s0 / 00 s2 [04:00]	ENKHJARGAL K. (MGL)
3	SZELECZKI Szabina (HUN)	DUDINA Kristina (AIN)	DUDINA K. (AIN)
4	YNAMEOVA Gozel (TKM)	34	YNAMEOVA G. (TKM)
5	HAGIANU Giorgia (ROU)	35	HAGIANU G. (ROU)
6	LOO Jayne (USA)	36	LOO J. (USA)
7	DIAZ HERNANDEZ Aitana (ESP)	37	DIAZ HERNANDEZ A. (ESP)
8	DEY Asmita (IND)	38	DEY A. (IND)
	FIELDER Anneliese (AUS)	39	FIELDER A. (AUS)

POOL B

9	BABULFATH Tara (SWE)	37	BABULFATH T. (SWE)
10	MEDILO Charlize Isabelle (CAN)	38	MEDILO C. (CAN)
11	POTSKHVERASHVILI Mariami (GEO)	39	POTSKHVERASHVILI M. (GEO)
12	SARSENBEK Nurailym (KAZ)	40	SARSENBEK N. (KAZ)
13	MIYAKI Kano (JPN)	41	MIYAKI K. (JPN)
14	GHIGLIONE Giulia (ITA)	42	GHIGLIONE G. (ITA)
15	SIBILLE Victoria (BEL)	43	SIBILLE V. (BEL)
16	LAU Wan Yee (HKG)	44	LAU W. (HKG)
17	FARIA Ines (POR)	45	FARIA I. (POR)
18	SHEN Yi-Chun (TPE)	46	SHEN Y. (TPE)
19	LEE Yoojin (KOR)	47	LEE Y. (KOR)

POOL C

17	CUQ Pauline (FRA)	41	CUQ P. (FRA)
18	MYAGMARSUREN Nandin-Erdene (MGL)	42	MYAGMARSUREN N. (MGL)
19	HILLER Harlee (USA)	43	HILLER H. (USA)
20	HO Lok Yi (HKG)	44	HO L. (HKG)
21	KURBANOVA Kurbanay (TKM)	45	KURBANOVA K. (TKM)
22	AVANZATO Asia (ITA)	46	AVANZATO A. (ITA)
23	PEREZ SOLER Eva (ESP)	47	PEREZ SOLER E. (ESP)
24	RIADI Nohade (MAR)	48	RIADI N. (MAR)
25	RODONAIA Julieta (GEO)	49	RODONAIA J. (GEO)
26	VAINSTEIN Sindi (MDA)	50	VAINSTEIN S. (MDA)

POOL D

25	SEGUNDA Eldimira (ANG)	45	SEGUNDA E. (ANG)
26	KOSZEGI Rebeka Rita (HUN)	46	KOSZEGI R. (HUN)
27	DUBOVSKAYA Irina (KAZ)	47	DUBOVSKAYA I. (KAZ)
28	ALIYEVA Konul (AZE)	48	ALIYEVA K. (AZE)
29	QUACH Heidi (CAN)	49	QUACH H. (CAN)
30	GABRIEL Vania (ANG)	50	GABRIEL V. (ANG)
31	GOGUA Maria Eleni (GRE)	51	GOGUA M. (GRE)
32	CHIU Chih-Jou (TPE)	52	CHIU C. (TPE)
33	BOGDAN Laura (ROU)	53	BOGDAN L. (ROU)
34	ALVES Constanca (POR)	54	ALVES C. (POR)
35	ERSIN Sila (TUR)	55	ERSIN S. (TUR)

REPECHAGE

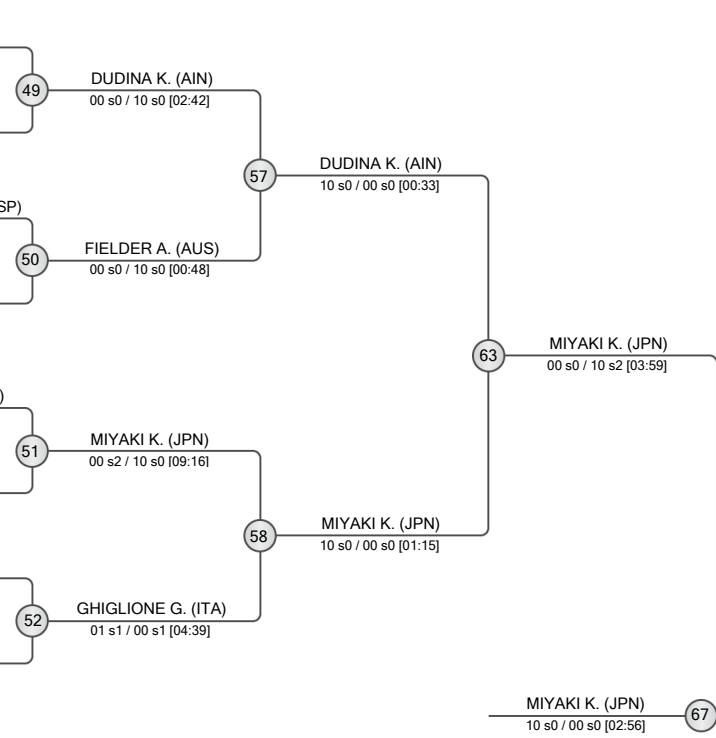
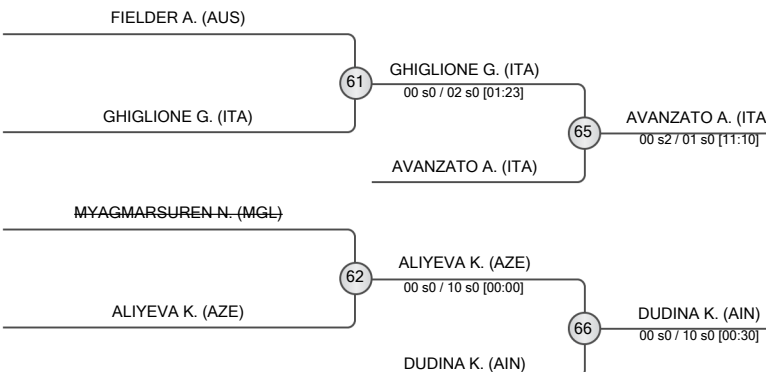

FINAL RESULTS	
1.	MIYAKI Kano (JPN)
2.	ERSIN Sila (TUR)
3.	AVANZATO Asia (ITA)
3.	DUDINA Kristina (AIN)
5.	GHIGLIONE Giulia (ITA)
5.	ALIYEVA Konul (AZE)
7.	FIELDER Anneliese (AUS)
7.	MYAGMARSUREN Nandin-Erdene (MGL)





Odivelas World Championships Juniors Individuals 2023

Portugal, Odivelas, 4-7 Oct 2023

-52 kg

Women (40)

POOL A

1	CARNA Giulia (ITA)	33	CARNA G. (ITA)
2	MARTINEZ VIRGEN Abril (MEX)	33	10 s0 / 00 s0 [01:33]
3	PIRES Fabiane (BRA)	34	HUH M. (KOR)
4	HUH Mio (KOR)	34	00 s0 / 11 s0 [02:33]
5	LEISHANGTHEM Nungshithoi Chanu (IND)	34	10 s0 / 00 s3 [04:44]
6	CATANA Luciana (ROU)	35	CATANA L. (ROU)
7	KELLER Rebeka (HUN)	35	10 s0 / 01 s0 [02:26]
8	JENMAN Charlotte (GBR)	36	GOMEZ ANTONA L. (ESP)
9	GOMEZ ANTONA Laura (ESP)	36	00 s1 / 02 s0 [01:51]
10	JURAEVA Gulkhayo (UZB)	36	JURAEVA G. (UZB)
11		36	00 s0 / 10 s0 [02:38]

POOL B

9	BEATON Evelyn (CAN)	37	BEATON E. (CAN)
10	GADASHOVA Khadizha (AZE)	37	01 s2 / 00 s2 [05:56]
11	NDIAYE Binta (SUI)	37	00 s0 / 10 s0 [01:00]
12	LAVY Ruth (ISR)	38	LAVY R. (ISR)
13	JUMAYEVA Zohre (TKM)	38	LAVY R. (ISR)
14	JUMAYEVA Z. (TKM)	38	10 s0 / 00 s0 [00:25]
15	DJERIOU Lena (GER)	39	DJERIOU L. (GER)
16	DJERIOU L. (GER)	39	02 s1 / 01 s0 [06:18]
17	EFIMOVA Karina (AIN)	40	BERES L. (FRA)
18	SHEN Yi-Hsi (TPE)	40	02 s1 / 00 s1 [03:19]
19	BERES Lea (FRA)	40	BERES L. (FRA)
20	BERES L. (FRA)	40	10 s0 / 00 s3 [06:05]
21	BAYANMUNKH Uranzaya (MGL)	40	BAYANMUNKH U. (MGL)
22		40	10 s0 / 00 s3 [06:05]

POOL C

17	TORO SOLER Ariane (ESP)	41	STAKHOV N. (GER)
18	STAKHOV Nicole (GER)	41	00 s0 / 01 s1 [04:00]
19	NURITDINOVA Maya (TKM)	42	VEG L. (HUN)
20	RAFKATOVA Sugdiyona (UZB)	42	00 s0 / 01 s1 [04:00]
21	VEG Luca (HUN)	42	VEG L. (HUN)
22	VEG Luca (HUN)	42	00 s0 / 10 s1 [02:18]
23	SCIACOVELLI Micaela (ITA)	43	SCIACOVELLI M. (ITA)
24	SCIACOVELLI M. (ITA)	43	10 s0 / 00 s0 [01:06]
25	TANIMOTO Kaycie (USA)	44	GAVALA E. (GRE)
26	TSIKLAURI Elene (GEO)	44	11 s1 / 00 s0 [03:18]
27	GAVALA Evangelia (GRE)	44	GAVALA E. (GRE)
28	DIAZ Fabiola (VEN)	44	DIAZ F. (VEN)
29		44	11 s1 / 00 s0 [03:18]

POOL D

25	NISAVIC Nikolina (SRB)	45	KAMIYA R. (JPN)
26	KAMIYA Rin (JPN)	45	00 s1 / 10 s1 [02:24]
27	POULANGE Alyssia (FRA)	46	KUTYLA O. (POL)
28	KUTYLA Oliwia (POL)	46	01 s1 / 00 s2 [04:00]
29	BIRRI Madeleine (GBR)	46	BIRRI M. (GBR)
30	BIRRI M. (GBR)	46	01 s1 / 00 s2 [04:00]
31	YEREZHEPOVA Aruzhan (KAZ)	47	VALIYEVA A. (AZE)
32	YEREZHEPOVA A. (KAZ)	47	00 s0 / 02 s0 [01:57]
33	TERBISH Ariunzaya (MGL)	48	KLAUS-STERNWIESER C. (AUT)
34	VALIYEVA Aydan (AZE)	48	00 s1 / 01 s2 [04:00]
35	LOPEZ Sheily (GUA)	48	LOPEZ S. (GUA)
36	LOPEZ S. (GUA)	48	00 s0 / 02 s0 [03:14]
37	KLAUS-STERNWIESER Carina (AUT)	48	KLAUS-STERNWIESER C. (AUT)
38		48	00 s0 / 02 s0 [03:14]

REPECHAGE

61	CATANA L. (ROU)	65	SCIACOVELLI M. (ITA)
62	LAVY R. (ISR)	65	00 s3 / 10 s1 [03:40]
63	VEG L. (HUN)	66	BERES L. (FRA)
64	KLAUS-STERNWIESER C. (AUT)	66	00 s0 / 02 s0 [03:14]
65	KLAUS-STERNWIESER C. (AUT)	66	00 s2 / 10 s0 [05:21]
66	BERES L. (FRA)	66	00 s0 / 02 s0 [03:14]

67 KAMIYA R. (JPN) 00 s1 / 10 s0 [02:19]

64 KAMIYA R. (JPN) 00 s1 / 10 s1 [01:39]

FINAL RESULTS		
1.	KAMIYA Rin	JPN
2.	CARNA Giulia	ITA
3.	SCIACOVELLI Micaela	ITA
3.	BERES Lea	FRA
5.	CATANA Luciana	ROU
5.	KLAUS-STERNWIESER Carina	AUT
7.	LAVY Ruth	ISR
7.	VEG Luca	HUN





Odivelas World Championships Juniors Individuals 2023

Portugal, Odivelas, 4-7 Oct 2023

-57 kg

Women (35)

POOL A

1	REIS Bianca (BRA)	33	REIS B. (BRA)
2	NISAVIC Kristina (SRB)	33	NISAVIC K. (SRB)
3	HONDA Riko (JPN)	34	HONDA R. (JPN)
4	ALIZADA Fidan (AZE)	34	ALIZADA F. (AZE)
5	HIDEN Verena (AUT)	35	HIDEN V. (AUT)
6	VERFAILLIE Luna (BEL)	35	VERFAILLIE L. (BEL)
7	JUNG Nari (KOR)	36	JUNG N. (KOR)
8	RIEGERT Helene (GER)	36	RIEGERT H. (GER)
	SABIROVA Chinora (TKM)	36	SABIROVA C. (TKM)

POOL B

9	COMANCHE Beatriz (BRA)	37	COMANCHE B. (BRA)
10	REDJEPOVA Farangiz (UZB)	37	REDJEPOVA F. (UZB)
11	LOLADZE Nino (GEO)	38	LOLADZE N. (GEO)
12	CASTELLANO HERNANDEZ Cinthia Paola (MEX)	38	CASTELLANO HERNANDEZ C. (MEX)
13	CAPANNI DIAS Thauany David (ITA)	39	CAPANNI DIAS T. (ITA)
14	MACIAS Jasmine (USA)	39	MACIAS J. (USA)
15	SAVOIE Mahee (CAN)	40	SAVOIE M. (CAN)
16	BEURSKENS Julie (NED)	40	BEURSKENS J. (NED)

POOL C

17	TONIOLO Veronica (ITA)	41	TONIOLO V. (ITA)
18	POLNICKA Marie (CZE)	41	POLNICKA M. (CZE)
19	ZIANE Wissal (MAR)	42	ZIANE W. (MAR)
20	DARJADA Shahin Rajakbhai (IND)	42	DARJADA S. (IND)
21	RODRIGUEZ SALVADOR Adriana (ESP)	43	RODRIGUEZ SALVADOR A. (ESP)
22	OYUNGEREL Oyunchimeg (MGL)	43	OYUNGEREL O. (MGL)
23	BUDAK Aysenur (TUR)	44	BUDAK A. (TUR)
24	LAUBER Natascha (GER)	44	LAUBER N. (GER)
	MIHHAILOVA Darja (EST)	44	MIHHAILOVA D. (EST)

POOL D

25	SALONEN Pihla (FIN)	45	SALONEN P. (FIN)
26	TSIKLAURI Nino (GEO)	45	TSIKLAURI N. (GEO)
27	MORENO Martina (CHI)	46	MORENO M. (CHI)
28	DE CARVALHO Alya (FRA)	46	DE CARVALHO A. (FRA)
29	CHMIELEWSKA Kinga (POL)	46	CHMIELEWSKA K. (POL)
30	PARDAYEVA Maysa (TKM)	47	PARDAYEVA M. (TKM)
31	SILVEIRA Maria (POR)	47	SILVEIRA M. (POR)
32	ABDIROVA Dana (KAZ)	48	ABDIROVA D. (KAZ)
	LIN Yu-Han (TPE)	48	LIN Y. (TPE)

REPECHAGE

61	BEURSKENS J. (NED)	65	BEURSKENS J. (NED)
62	RODRIGUEZ SALVADOR A. (ESP)	66	COMANCHE B. (BRA)

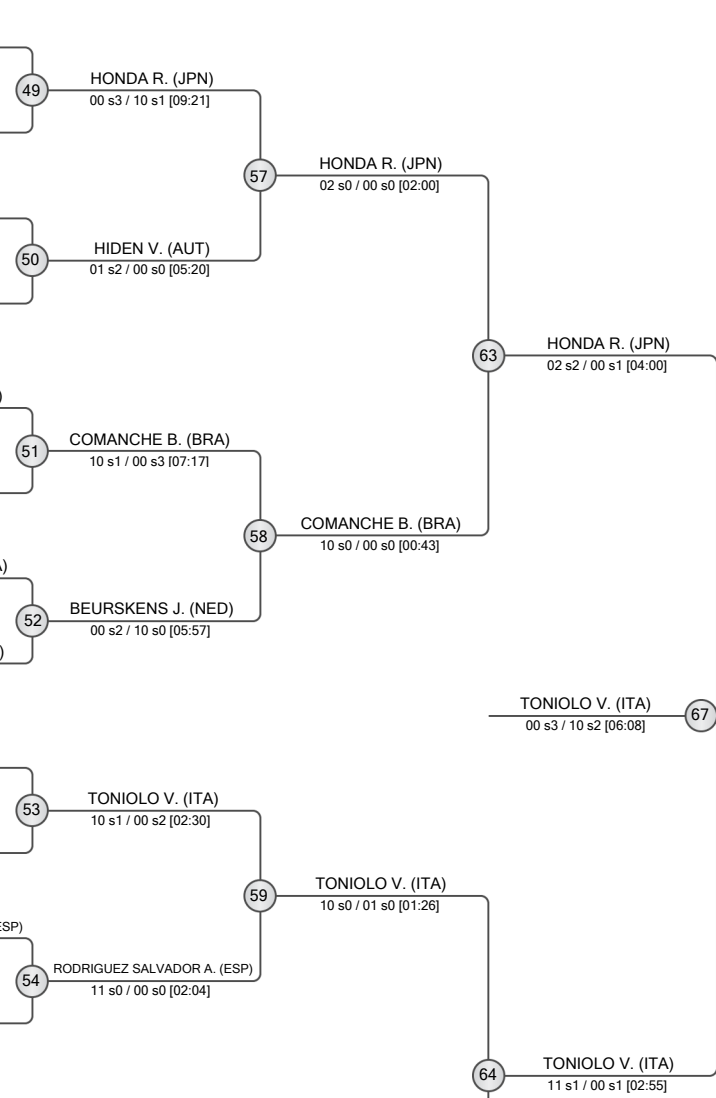

FINAL RESULTS	
1.	TONIOLO Veronica (ITA)
2.	HONDA Riko (JPN)
3.	BEURSKENS Julie (NED)
3.	COMANCHE Beatriz (BRA)
5.	SALONEN Pihla (FIN)
7.	HIDEN Verena (AUT)
7.	ABDIROVA Dana (KAZ)





Odivelas World Championships Juniors Individuals 2023

Portugal, Odivelas, 4-7 Oct 2023

-63 kg

Women (40)

POOL A

	AUCHECORNE Melkia	FRA
	ZUCCO Agnese	ITA
	MORGADO Joana	POR
	KELEMEN Adel	HUN
	BOCHKOVA Despina	UZB
	YERGALIYEVA Samalay	KAZ
	KROON Esmee	NED
	SHARMA Unnati	IND
	SEIKKULA Louna-Lumia	FIN
	NARYMANOVA Nasiba	TKM

1	AUCHECORNE M. (FRA)	
2	ZUCCO A. (ITA)	33
3	KELEMEN A. (HUN)	
4	BOCHKOVA D. (UZB)	34
5	YERGALIYEVA S. (KAZ)	
6	KROON E. (NED)	35
7	SEIKKULA L. (FIN)	
8	NARYMANOVA N. (TKM)	36

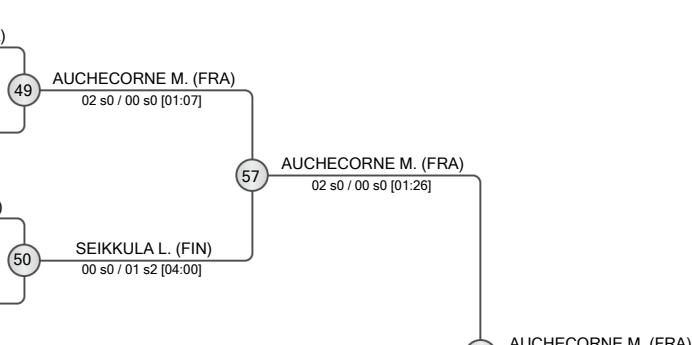

POOL B

	JASPE Emily Daniela	USA
	FERNANDEZ HERRERA Aitana	ESP
	XANTHOPOULOU Sofia	GRE
	BRAS Margarida	POR
	SIMIC Nina	CRO
	GLUBIAK Martyna	POL
	NOACK Nele	GER
	CHAYEB Aquilina	LBN
	SKALSKA Anna	CZE
	CAMARA Sophia	BRA

9	JASPE E. (USA)	
10	FERNANDEZ HERRERA A. (ESP)	37
11	BRAS M. (POR)	
12	SIMIC N. (CRO)	38
13	GLUBIAK M. (POL)	
14	NOACK N. (GER)	39
15	SKALSKA A. (CZE)	40
16	CAMARA S. (BRA)	40

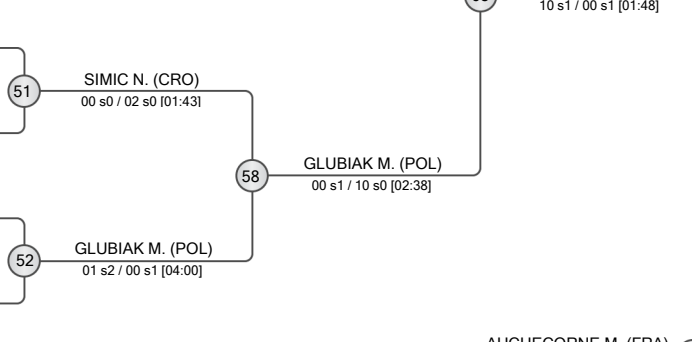

POOL C

	GHANEM Fatma	EGY
	SILVA Mafalda	POR
	YANG Jimin	KOR
	DARKHANBATBAYAR Yesui	MGL
	TOMANKOVA Lenka	SVK
	SILVA Nauana	BRA
	SIRINIDOU Galini	GRE
	ROSSET Aline	SUI
	TAKAKI Mizuki	JPN
	CARROUTH Karlee	USA

17	GHANEM F. (EGY)	
18	SILVA M. (POR)	41
19	YANG J. (KOR)	
20	TOMANKOVA L. (SVK)	42
21	SILVA N. (BRA)	
22	ROSSET A. (SUI)	43
23	TAKAKI M. (JPN)	
24	CARROUTH K. (USA)	44

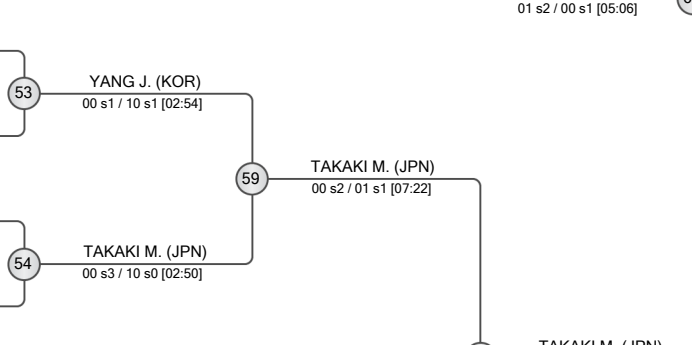

POOL D

	PALUMBO Antonietta	ITA
	FALGON Julie	FRA
	POZO FLORES Naomi	MEX
	TORRES Adriana	POR
	ASKILASHVILI Eter	GEO
	RAMETTA Ryley	AUS
	PEREZ Constanza	CHI
	OSTLIND Gretha	SWE
	SLIMANI Dounia	MAR
	KRIZA Anna	HUN

25	PALUMBO A. (ITA)	
26	FALGON J. (FRA)	45
27	TORRES A. (POR)	
28	ASKILASHVILI E. (GEO)	46
29	RAMETTA R. (AUS)	
30	OSTLIND G. (SWE)	47
31	SLIMANI D. (MAR)	
32	KRIZA A. (HUN)	48

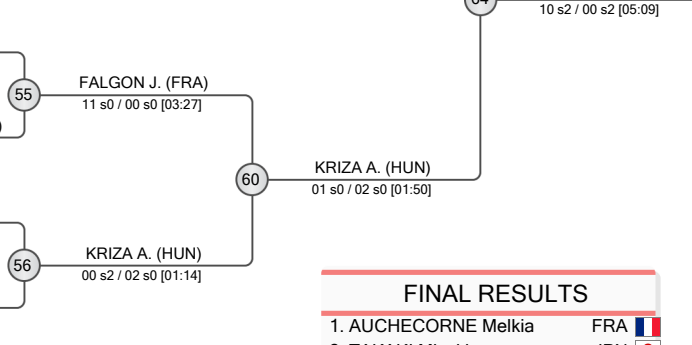

REPECHAGE

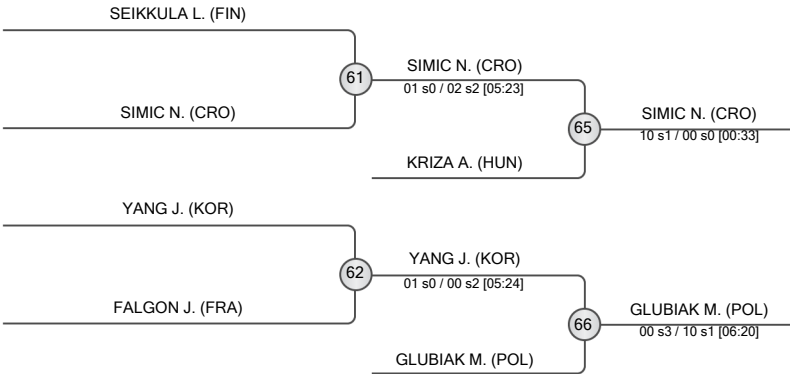

FINAL RESULTS

1.	AUCHECORNE Melkia	FRA	
2.	TAKAKI Mizuki	JPN	
3.	SIMIC Nina	CRO	
3.	GLUBIAK Martyna	POL	
5.	KRIZA Anna	HUN	
5.	YANG Jimin	KOR	
7.	SEIKKULA Louna-Lumia	FIN	
7.	FALGON Julie	FRA	





Odivelas World Championships Juniors Individuals 2023

Portugal, Odivelas, 4-7 Oct 2023

-70 kg

Women (35)

POOL A

	RASOANAIVO RAZAFY Aina Laura	MAD	1
	COLON Sairy	PUR	2
	KANELLOPOULOU Melina	GRE	3
	FOHOOU April Lynn	SUI	4
	SCHUSTER Kaja	SLO	5
	KARSANOVA Viktoriia	AIN	6
	DAMIANO GUERRERO Esmeralda	DOM	7
	LEE Yerang	KOR	8
	KODIROVA Barchinoy	UZB	8

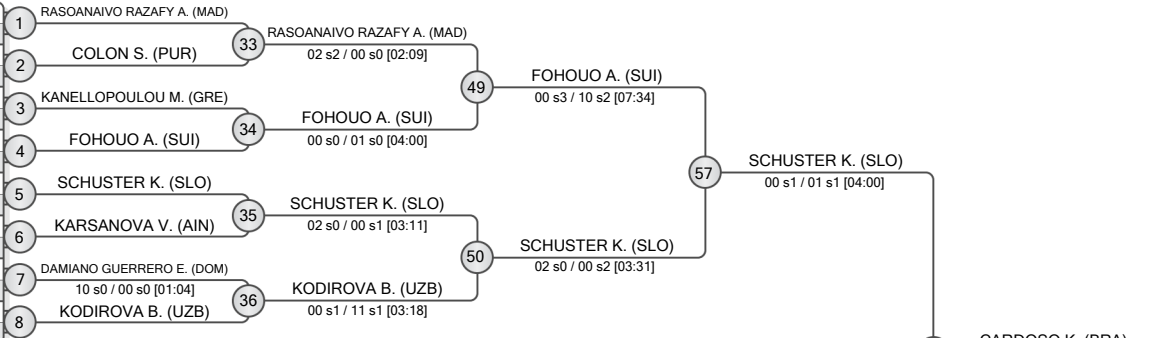

POOL B

	ZARYBNICKA Julie	CZE	9
	GRAUER Tayla	GER	10
	BAR OR G. Gaya	ISR	11
	CICEK Seyda Nur	TUR	12
	KOWALEWSKA Aleksandra	POL	13
	ASKHAT Azhar	KAZ	14
	VATS Nandani	IND	15
	CARDOSO Kaillany	BRA	16

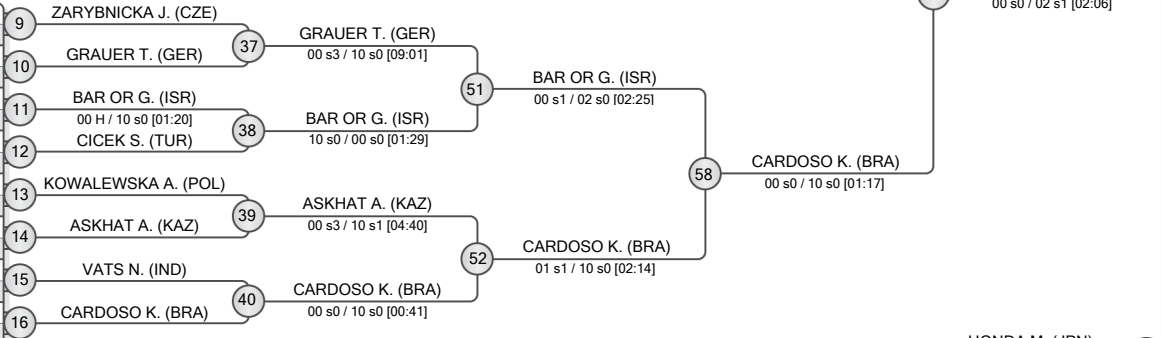

POOL C

	BOCK Samira	GER	17
	HONDA Mayu	JPN	18
	JAKOBSEN Ida	DEN	19
	PAPAGIANNAKI Alexandra	GRE	20
	KOREN Nika	SLO	20
	BIRON Laurence	CAN	21
	RAZZOKBERDIEVA Khurshida	UZB	22
	JACKSON Brinley	USA	23
	CAKAREVIC Jovana	SRB	24

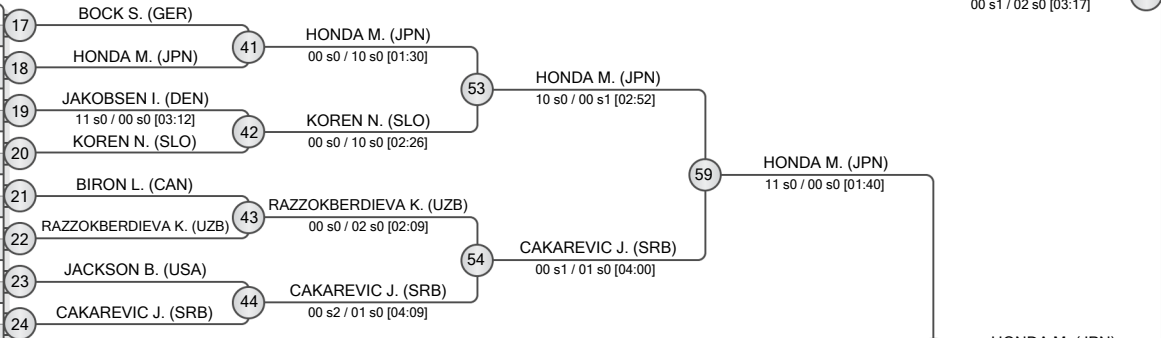

POOL D

	DENGG Elena	AUT	25
	RIBEIRO NOVAIS Maya	SWE	26
	PINA Tais	POR	27
	MIDDLETON Saya	AUS	28
	KULIC Karla	CRO	29
	USANOVA Valeria	EST	30
	NOVITZKI Adelina	ISR	31
	GULBANI Nino	GEO	32

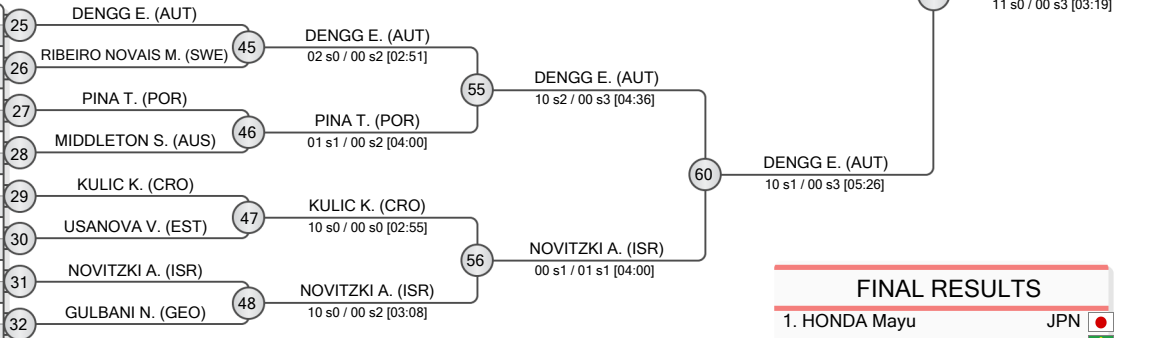

REPECHAGE

FOHOOU A. (SUI)	61	FOHOOU A. (SUI)	02 s0 / 00 s0 [01:51]
BAR OR G. (ISR)	61	DENGG E. (AUT)	00 s2 / 01 s1 [04:47]
CAKAREVIC J. (SRB)	62	NOVITZKI A. (ISR)	00 s0 / 01 s1 [04:00]
NOVITZKI A. (ISR)	62	SCHUSTER K. (SLO)	00 s0 / 10 s0 [00:19]

FINAL RESULTS		
1.	HONDA Mayu	JPN
2.	CARDOSO Kaillany	BRA
3.	DENGG Elena	AUT
3.	SCHUSTER Kaja	SLO
5.	FOHOOU April Lynn	SUI
7.	NOVITZKI Adelina	ISR
7.	BAR OR Gaya	ISR
7.	CAKAREVIC Jovana	SRB





Odivelas World Championships Juniors Individuals 2023

Portugal, Odivelas, 4-7 Oct 2023

-78 kg

Women (31)

POOL A

	DERKS Lieke	NED
	ESPINOZA Adela	CHI
	VOLO MACHIN Laura	ESP
	OLAYA Brenda	COL
	WANG Chieh-Hsi	TPE
	VULPASIN Maria-Nicoleta	GRE
	RUPP Canna	USA

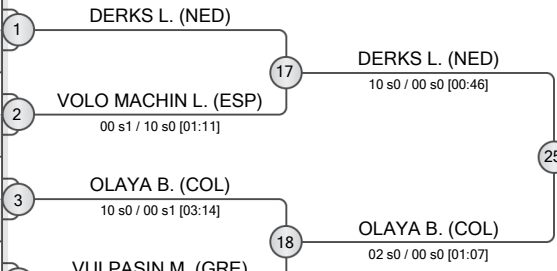

POOL B

	NIEMEYER Mathilda Sophie	GER
	HIRANO Yume	JPN
	BOUVIER Ilana	FRA
	CONCEICAO Fabia	POR
	MICHAELIDOU Zanet	CYP
	ARJU Arju	IND
	IBRAEVA Shinar	UZB
	TELBAYEVA Diana	KAZ

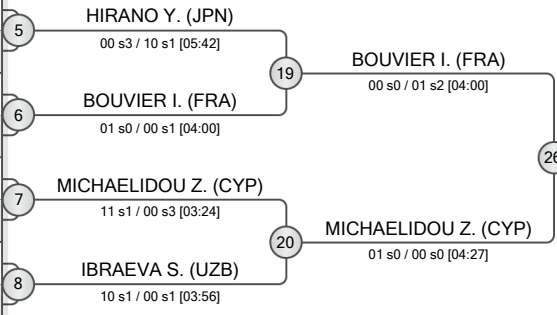

POOL C

	RUBIANO Morgane	FRA
	KIM Minju	KOR
	SAGI Nikolett	HUN
	YU Sin-Yi	TPE
	YULDOSHOVA Shirinjon	UZB
	INSUA IGLESIAS Noelia	ESP
	LUDEMA Berber	NED
	HASSAN Anya	GBR

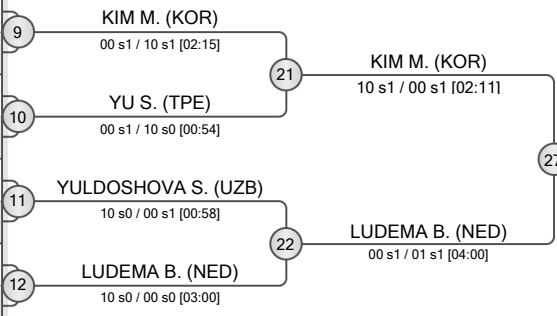

POOL D

	TUREK Aleksandra	POL
	KRAPU Emma	FIN
	NAGACHEVSKAYA Anastasiya	KAZ
	OTGONBAYAR Khuslen	MGL
	GABALLA Aya	EGY
	AMIRLI Narmin	AZE
	BUDDENKOTTE Eva Ronja	GER
	NAKANO Mika	JPN

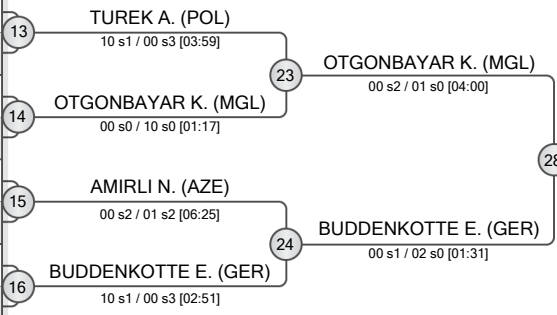

REPECHAGE

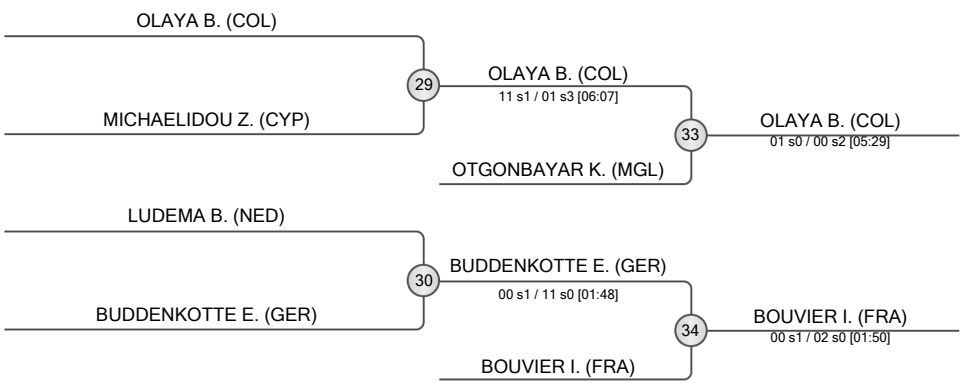

FINAL RESULTS	
1. KIM Minju	KOR
2. DERKS Lieke	NED
3. OLAYA Brenda	COL
3. BOUVIER Ilana	FRA
5. OTGONBAYAR Khuslen	MGL
5. BUDDENKOTTE Eva Ronja	GER
7. MICHAELIDOU Zanet	CYP
7. LUDEMA Berber	NED





Odivelas World Championships Juniors Individuals 2023

Portugal, Odivelas, 4-7 Oct 2023

+78 kg

Women (24)

POOL A

	SWEERS Paulien	NED
	PAPIDZE Nino	GEO
	ENKHBAYAR Enkhzul	MGL
	MARINI Tiziana	ITA
	MILER Georgiana	ROU
	MANE Rosa	POR

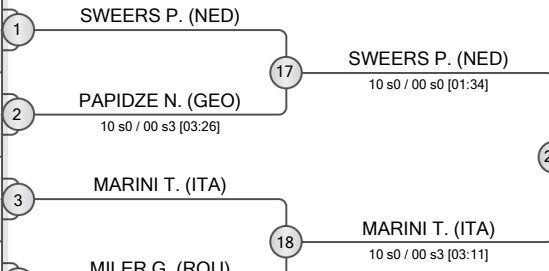

POOL B

	MISHINER Yuli Alma	ISR
	CANCAN Celia	FRA
	GOMEZ Jessica	MEX
	ARAI Mao	JPN
	VRANJES Marcelina	CRO
	SULEYMANOVA Nigar	AZE

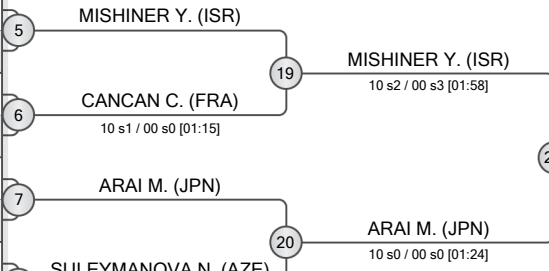

POOL C

	ALVES Katia	BRA
	ETXEBARRIA BILBAO Eunate	ESP
	TUKHTAMISHEVA Mokhlaroyim	UZB
	DIRGEN Duygu	TUR
	STASIULYTE Rugile	LTU
	MUKUNOKI Miki	JPN

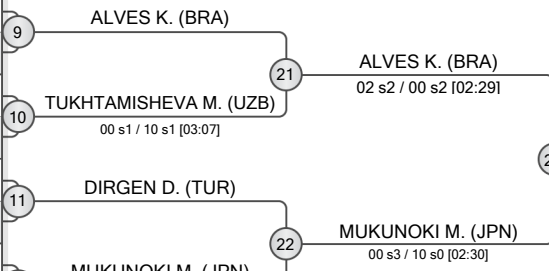

POOL D

	TAKIYEVA Karina	KAZ
	SHARAF Farah	EGY
	LEE Hyeonji	KOR
	PIRES Enya	BRA
	KAUR Kanwarpreet	IND
	ALAYNICK Jessica	USA

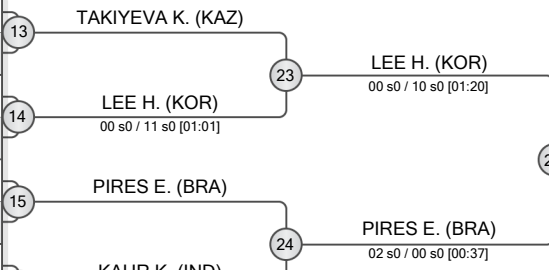

REPECHAGE

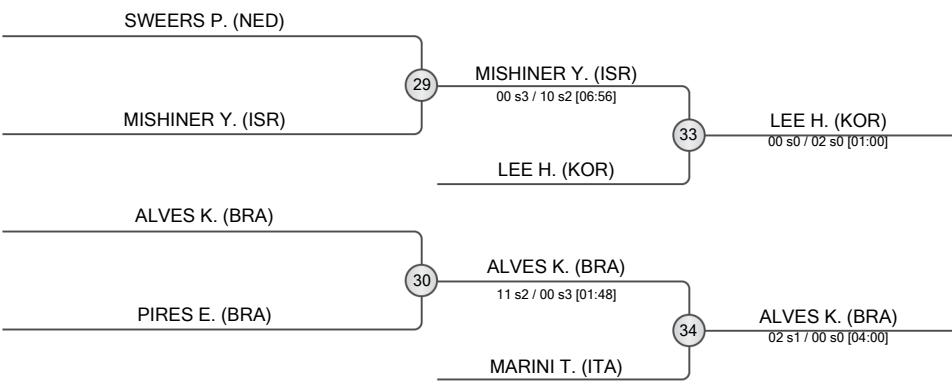

FINAL RESULTS	
1. ARAI Mao	JPN
2. MUKUNOKI Miki	JPN
3. LEE Hyeonji	KOR
3. ALVES Katia	BRA
5. MISHINER Yuli Alma	ISR
5. MARINI Tiziana	ITA
7. SWEERS Paulien	NED
7. PIRES Enya	BRA

