



Event Report

Dushanbe World Championships Juniors Individuals 2024, 2-5 Oct 2024

Event Report

531 competitors from 67 nations

290 Men

241 Women

54.61%

45.39%

-60 kg	-66 kg	-73 kg	-81 kg	-90 kg	-100 kg	+100 kg	Men
43	46	54	43	38	35	31	290

-48 kg	-52 kg	-57 kg	-63 kg	-70 kg	-78 kg	+78 kg	Women
37	37	43	33	39	32	20	241

Continent	AJU	JUA	EJU	OJU	PJC	Total
Nations	6	18	35	1	7	67
Competitors	23	203	248	4	53	531

Schedule				
Date	2 Oct	3 Oct	4 Oct	5 Oct
Start	09:00	10:00	10:30	10:00
Finals	16:00	16:00	16:00	16:00



-60 kg		
1	FUKUDA Yamato	JPN
2	KUDBUDINOV Loiq	TJK
3	MURODILLAEV Murodil	UZB
3	ORYNBASSAR Talgat	KAZ
5	YANG Jonathan	USA
5	IMRANOV Nizami	AZE
7	ULIANOV Vladimir	IJF
7	MANFERLOTTI Vincenzo	ITA

-66 kg		
1	FUKUCHI Shuntaro	JPN
2	KENTOKU Kairi	JPN
3	KOBETS German	IJF
3	DE LUCA Alessio	ITA
5	MYRADOV Toyly	TKM
5	BEKMURODOV Zamohshari	UZB
7	MUSAYEV Mahammad	AZE
7	ALZHANOV Magzhan	KAZ

-73 kg		
1	KIHARA Keito	JPN
2	TAKEICHI Yusuke	JPN
3	RAVSHANOV Mardon	UZB
3	ASADULLOEV Muhiddin	TJK
5	PARLATI Manuel	ITA
5	IUSUPOV Abubakar	IJF
7	TOSHEV Khojiakbar	UZB
7	CROITORU Renat	MDA

-81 kg		
1	JAVAKHISHVILI Luka	GEO
2	WANG Jiangnan	CHN
3	SHUKUROV Suleyman	AZE
3	KUMISBAY Azat	KAZ
5	YUSUFZODA Muhammad	TJK
5	MUSOEV Sunatullo	TJK
7	ALMEIDA Luan	BRA
7	DE LANGE Joshua	NED

-90 kg		
1	KAWABATA Komei	JPN
2	MALKIN Egor	IJF
3	SAMANOV Alisher	UZB
3	GHIMBOVSCHI Vadim	MDA
5	OWUSU Henry Owusu Asare	ITA
5	BIRZHANOV Askar	KAZ
7	KOTSOEV Aslan	AZE
7	KUTENKOV Ivan	UKR

-100 kg		
1	SODIKOV Mukhammadsodik	UZB
2	MIKI Nozomu	JPN
3	MEKHOUKH Fares	FRA
3	BAGHIROV Azhdar	AZE
5	ARSENIE Rares	ROU
5	NIKSERESHT Ali Reza	IRI
7	LAKOS Mate	HUN
7	KUBIAK Damian	POL

+100 kg		
1	BATCHAEV Denis	IJF
2	NASIBOV Kanan	AZE
3	TATAROGLU Ibrahim	TUR
3	KARDAVA Saba	GEO
5	DOBRE Darius	ROU
5	KADZAEV Arsen	IJF
7	BAEK Dusan	KOR
7	SEMENENKO Alex	USA



-48 kg		
1	HUI Xinran	CHN
2	YOSHINO Sachiyo	JPN
3	DUDINA Kristina	IJF
3	RIBEIRO Clarice	BRA
5	VALERIANI Rebecca	ITA
5	SZELECZKI Szabina	HUN
7	FILKINA Lana	IJF
7	SHAW Summer	GBR

-52 kg		
1	OI Iroha	JPN
2	NOSHO Senju	JPN
3	HUH Mio	KOR
3	POULANGE Alyssia	FRA
5	VALIYEVA Aydan	AZE
5	RODRIGUES Rafaela	BRA
7	QURBONZODA Madina	TJK
7	BAYANMUNKH Uranzaya	MGL

-57 kg		
1	HONDA Riko	JPN
2	TAO Yuying	CHN
3	REIS Bianca	BRA
3	SIENNICKA Karolina	POL
5	COMANCHE Beatriz	BRA
5	SAEZ HEVIA Adriana	ESP
7	ALIZADA Fidan	AZE
7	CARNA Giulia	ITA

-63 kg		
1	AUCHECORNE Melkia	FRA
2	RUSSO Savita	ITA
3	MORICHKA So	JPN
3	SKALSKA Anna	CZE
5	CORBO Sara	ITA
5	TOKAS Himanshi	IND
7	YANG Jimin	KOR
7	TRETNJAK Lisa	AUT

-70 kg		
1	DENGG Elena	AUT
2	FOHOOU April Lynn	SUI
3	SCHUSTER Kaja	SLO
3	GRAUER Tayla	GER
5	YUAN Huiting	CHN
5	MAEDA Rin	JPN
7	CARDOSO Kaillany	BRA
7	RASOANAIVO RAZAFY Aina Laura	MAD

-78 kg		
1	OLAYA Brenda	COL
2	NIEMEYER Mathilda Sophie	GER
3	BUDDENKOTTE Eva Ronja	GER
3	CAMILO Dandara	BRA
5	MAZZARINO Lila	FRA
5	IUDINA Polina	IJF
7	KOSNAROVA Marie	CZE
7	KRAPU Emma	FIN

+78 kg		
1	LEE Hyeonji	KOR
2	CANCAN Celia	FRA
3	YAMAGUCHI Chihiro	JPN
3	SOLIMAN Safa	EGY
5	OLIVEIRA Olivia	BRA
5	LIU Yu	CHN
7	STASIULYTE Rugile	LTU
7	VRANJES Marcelina	CRO



Medals

Dushanbe World Championships Juniors Individuals 2024, 2-5 Oct 2024

Medals

#	Nation	1. Place	2. Place	3. Place	5. Place	7. Place
1.	JPN Japan	6	5	2	1	
2.	CHN People's Republic of China	1	2		2	
3.	FRA France	1	1	2	1	
4.	UZB Uzbekistan	1		3	1	1
5.	KOR Republic of Korea	1		1		2
6.	GEO Georgia	1		1		
7.	AUT Austria	1				1
8.	COL Colombia	1				
9.	AZE Azerbaijan		1	2	2	3
10.	GER Germany		1	2		
11.	ITA Italy		1	1	4	2
12.	TJK Tajikistan		1	1	2	1
13.	SUI Switzerland		1			
14.	BRA Brazil			3	3	2
15.	KAZ Kazakhstan			2	1	1
16.	CZE Czechia			1		1
16.	POL Poland			1		1
16.	MDA Republic of Moldova			1		1
19.	EGY Egypt			1		
19.	SLO Slovenia			1		
19.	TUR Türkiye			1		
22.	ROU Romania				2	
23.	HUN Hungary				1	1
23.	USA United States of America				1	1
25.	IND India				1	
25.	IRI Islamic Republic of Iran				1	
25.	ESP Spain				1	
25.	TKM Turkmenistan				1	
29.	CRO Croatia					1
29.	FIN Finland					1
29.	GBR Great Britain					1
29.	LTU Lithuania					1
29.	MAD Madagascar					1
29.	MGL Mongolia					1
29.	NED Netherlands					1
29.	UKR Ukraine					1

Official person:



Statistics

Dushanbe World Championships Juniors Individuals 2024, 2-5 Oct 2024

Statistics

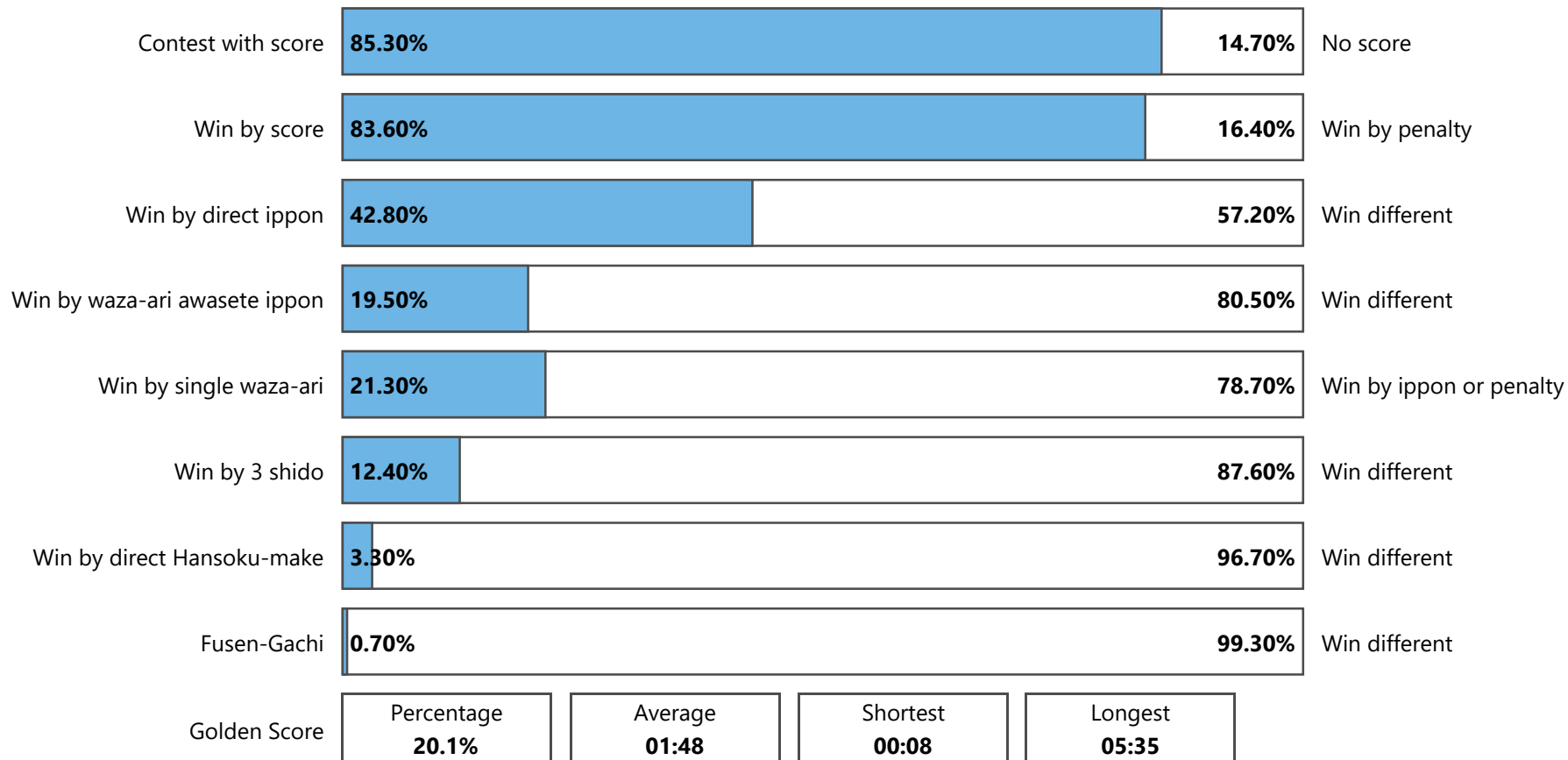



Statistics

Dushanbe World Championships Juniors Individuals 2024, 2-5 Oct 2024

Statistics

	-60	-66	-73	-81	-90	-100	+100	M	-48	-52	-57	-63	-70	-78	+78	W	Total
Competitors	43	46	54	43	38	35	31	290	37	37	43	33	39	32	20	241	531
Contests	46	49	57	46	41	38	34	311	40	40	46	36	42	35	23	262	573
Contests with score	38	43	52	42	31	34	26	266	34	35	41	29	33	30	21	223	489
Contests with score %	82.6%	87.8%	91.2%	91.3%	75.6%	89.5%	76.5%	85.5%	85%	87.5%	89.1%	80.6%	78.6%	85.7%	91.3%	85.1%	85.3%
Wins by Score	38	42	52	42	30	31	24	259	32	35	41	29	33	29	21	220	479
Wins by Score %	82.6%	85.7%	91.2%	91.3%	73.2%	81.6%	70.6%	83.3%	80%	87.5%	89.1%	80.6%	78.6%	82.9%	91.3%	84.0%	83.6%
Wins by direct Ippon	23	27	26	16	16	15	17	140	14	20	19	10	15	16	11	105	245
Wins by direct Ippon %	50%	55.1%	45.6%	34.8%	39%	39.5%	50%	45.0%	35%	50%	41.3%	27.8%	35.7%	45.7%	47.8%	40.1%	42.8%
Wins by Waza-ari Awasete Ippon	7	6	8	10	9	10	6	56	11	4	8	7	10	8	8	56	112
Wins by Waza-ari Awasete Ippon %	15.2%	12.2%	14%	21.7%	22%	26.3%	17.6%	18.0%	27.5%	10%	17.4%	19.4%	23.8%	22.9%	34.8%	21.4%	19.5%
Wins by single Waza-ari	8	9	18	16	5	6	1	63	7	11	14	12	8	5	2	59	122
Wins by single Waza-ari %	17.4%	18.4%	31.6%	34.8%	12.2%	15.8%	2.9%	20.3%	17.5%	27.5%	30.4%	33.3%	19%	14.3%	8.7%	22.5%	21.3%
Wins by 3 Shido for opponent	6	3	5	3	10	5	10	42	7	3	2	6	7	2	2	29	71
Wins by 3 Shido for opponent %	13%	6.1%	8.8%	6.5%	24.4%	13.2%	29.4%	13.5%	17.5%	7.5%	4.3%	16.7%	16.7%	5.7%	8.7%	11.1%	12.4%
Direct Hansoku-make	2	4		1	1	2		10	1	2	2		1	3		9	19
Wins by direct Hansoku-make %	4.3%	8.2%	0%	2.2%	2.4%	5.3%	0%	3.2%	2.5%	5%	4.3%	0%	2.4%	8.6%	0%	3.4%	3.3%
Fusen-gachi											1	1	1	1		4	4
Fusen-gachi %	0%	0%	0%	0%	0%	0%	0%	0%	0%	0%	2.2%	2.8%	2.4%	2.9%	0%	1.5%	0.7%
All positive Scores (Waza-ari + direct Ippon)	53	61	66	64	45	48	39	376	49	42	56	40	48	42	30	307	683
Average Scores per contests	1.2	1.2	1.2	1.4	1.1	1.3	1.1	1.21	1.2	1.1	1.2	1.1	1.1	1.2	1.3	1.17	1.19
All penalties (Shido + HSK)	81	88	94	80	87	72	84	586	56	65	61	50	92	40	30	394	980
Average penalty per contest	1.8	1.8	1.6	1.7	2.1	1.9	2.5	1.91	1.4	1.6	1.3	1.4	2.2	1.1	1.3	1.47	1.69
Golden Score	10	6	11	8	8	6	7	56	10	15	9	8	8	6	3	59	115
Golden Score %	21.7%	12.2%	19.3%	17.4%	19.5%	15.8%	20.6%	18.0%	25%	37.5%	19.6%	22.2%	19%	17.1%	13%	22.5%	20.1%
Osae-komi																	
Osae-komi %	0%	0%	0%	0%	0%	0%	0%	0%	0%	0%	0%	0%	0%	0%	0%	0%	0%
Wins by Penalty	8	7	5	4	11	7	10	52	8	5	4	6	8	5	2	38	90



Nations Overview

Dushanbe World Championships Juniors Individuals 2024, 2-5 Oct 2024

Nations

Overview

			-60	-66	-73	-81	-90	-100	+100	M	-48	-52	-57	-63	-70	-78	+78	W	Total	D	
1.		ALG	Algeria	0	2	1	0	0	0	0	3	0	0	0	0	0	0	0	3	3	
2.		ARM	Armenia	2	0	2	0	0	0	0	4	0	0	0	0	0	0	0	4	1	
3.		AUS	Australia	0	0	2	1	0	1	0	4	0	0	0	0	0	0	0	4	1	
4.		AUT	Austria	0	0	0	1	0	0	0	1	0	1	0	2	1	0	0	5	3	
5.		AZE	Azerbaijan	1	2	1	1	2	1	1	9	1	2	1	0	0	0	0	4	13	14
6.		BEL	Belgium	0	0	0	0	0	0	0	0	1	0	0	0	0	0	1	2	1	
7.		BRA	Brazil	1	2	1	1	1	2	1	9	1	1	2	1	1	1	2	9	18	7
8.		BUL	Bulgaria	0	2	2	1	0	0	0	5	0	1	0	0	0	0	0	1	6	2
9.		CAN	Canada	1	0	1	0	0	0	1	3	2	1	2	0	0	0	0	5	8	3
10.		CHI	Chile	0	0	1	0	0	0	0	1	0	0	0	0	0	0	0	0	1	1
11.		CHN	People's Republic of China	1	1	2	1	1	1	2	9	1	1	1	1	1	2	2	9	18	5
12.		CIV	Côte d'Ivoire	0	0	1	0	0	0	0	1	0	0	0	0	0	0	0	0	1	1
13.		COL	Colombia	1	0	1	1	0	0	0	3	0	0	0	1	0	1	0	2	5	1
14.		CRO	Croatia	0	0	0	0	1	0	0	1	0	0	0	2	1	1	1	5	6	4
15.		CYP	Cyprus	0	1	0	0	0	0	0	1	0	0	0	0	0	0	0	0	1	1
16.		CZE	Czechia	0	0	0	0	0	1	0	1	0	0	0	1	0	1	0	2	3	3
17.		DEN	Denmark	0	0	1	0	0	0	0	1	0	0	0	0	0	0	0	0	1	1
18.		EGY	Egypt	1	0	1	1	2	1	0	6	0	0	0	0	0	0	1	1	7	2
19.		ESP	Spain	1	0	1	0	1	1	0	4	2	2	2	0	0	1	0	7	11	6
20.		EST	Estonia	0	0	0	0	0	1	0	1	0	0	0	0	0	0	0	0	1	1
21.		FIN	Finland	0	0	0	0	0	0	0	0	0	0	0	0	0	1	0	1	1	1
22.		FRA	France	2	2	2	0	1	2	0	9	1	2	1	1	2	1	1	9	18	7
23.		GBR	Great Britain	1	1	2	2	0	0	1	7	1	0	2	0	1	0	0	4	11	4
24.		GEO	Georgia	0	0	2	2	1	2	2	9	1	0	1	1	0	0	1	4	13	8
25.		GER	Germany	0	1	1	0	1	2	1	6	0	2	1	2	2	2	0	9	15	7
26.		GRE	Greece	0	0	0	2	0	0	0	2	0	0	0	0	1	1	0	2	4	2
27.		HKG	Hong Kong, China	0	0	0	0	0	0	0	0	2	0	0	0	0	0	0	2	2	1
28.		HUN	Hungary	0	2	0	0	1	2	0	5	2	1	1	0	0	1	0	5	10	3
29.		IJF	International Judo Federation	1	2	4	1	2	0	3	13	3	1	1	1	2	3	0	11	24	13
		IJF	IJF	0	0	0	0	0	0	0	0	0	0	0	0	0	0	0	0	0	48
30.		IND	India	1	1	1	1	0	2	2	8	1	1	2	1	1	2	1	9	17	2
31.		IRI	Islamic Republic of Iran	0	0	0	1	1	1	2	5	0	0	0	0	0	0	0	0	5	4
32.		ITA	Italy	2	2	2	1	2	0	0	9	2	2	2	2	0	0	0	8	17	6
33.		JPN	Japan	1	2	2	1	1	1	1	9	1	2	2	1	1	1	1	9	18	12
34.		KAZ	Kazakhstan	2	2	1	2	1	0	1	9	2	2	1	1	2	0	1	9	18	14
35.		KEN	Kenya	1	1	1	1	0	0	0	4	0	0	1	1	1	0	0	3	7	4
36.		KGZ	Kyrgyzstan	1	2	2	1	2	0	1	9	1	1	2	2	1	2	0	9	18	4
37.		KOR	Republic of Korea	2	1	1	1	1	2	1	9	1	2	1	1	1	1	2	9	18	4
38.		KSA	Saudi Arabia	1	1	1	1	0	0	0	4	0	0	0	0	0	0	0	0	4	2
39.		LAT	Latvia	0	0	0	1	0	0	0	1	0	0	0	0	0	0	0	0	1	1
40.		LBN	Lebanon	0	0	0	0	0	0	0	0	0	0	0	0	1	0	0	1	1	1
41.		LTU	Lithuania	0	1	0	2	0	0	0	3	0	0	0	1	1	0	1	3	6	2
42.		LUX	Luxembourg	0	0	0	0	1	0	0	1	0	0	0	0	0	0	0	0	1	1
43.		MAD	Madagascar	0	0	0	0	0	0	0	0	0	0	0	0	1	0	0	1	1	2
44.		MAR	Morocco	1	0	1	0	0	0	0	2	1	0	0	0	1	0	0	2	4	2
45.		MAS	Malaysia	0	0	0	1	0	0	0	1	0	0	0	0	0	0	0	0	1	1



Nations Overview

Dushanbe World Championships Juniors Individuals 2024, 2-5 Oct 2024

Nations

Overview

			-60	-66	-73	-81	-90	-100	+100	M	-48	-52	-57	-63	-70	-78	+78	W	Total	D		
46.		MDA	Republic of Moldova		1	0	2	1	1	0	0	5	0	0	0	0	0	0	0	5	1	
47.		MEX	Mexico		2	1	0	0	0	0	0	3	0	0	0	1	0	0	0	1	4	2
48.		MGL	Mongolia		2	1	1	1	0	0	1	6	1	2	2	1	1	1	0	8	14	3
49.		MNE	Montenegro		0	0	0	0	0	1	0	1	0	0	0	0	0	0	0	0	1	1
50.		NED	Netherlands		0	0	0	1	1	1	0	3	0	0	0	1	0	1	0	2	5	7
51.		PAK	Pakistan		0	0	0	0	0	0	0	0	0	1	0	0	0	0	0	1	1	0
52.		PER	Peru		0	1	0	0	0	0	0	1	0	1	0	0	0	0	0	1	2	1
53.		POL	Poland		1	0	1	1	1	1	0	5	0	1	2	1	2	0	0	6	11	7
54.		POR	Portugal		0	0	0	0	0	0	0	0	0	0	0	0	0	1	0	1	1	1
55.		QAT	Qatar		0	0	0	0	0	0	0	0	0	0	1	0	0	0	0	1	1	1
56.		ROU	Romania		0	0	0	0	1	2	1	4	1	1	1	0	0	0	0	3	7	3
57.		SLO	Slovenia		0	0	0	0	1	0	0	1	0	0	0	0	2	0	0	2	3	1
58.		SRB	Serbia		2	0	0	2	1	1	0	6	0	1	1	0	1	1	0	4	10	5
59.		SUI	Switzerland		0	1	0	0	0	0	0	1	0	0	2	0	1	0	0	3	4	1
60.		SVK	Slovakia		1	0	0	0	0	1	0	2	0	0	0	0	1	0	0	1	3	5
61.		TJK	Tajikistan		3	3	2	3	2	2	2	17	2	1	2	1	0	0	1	7	24	17
62.		TKM	Turkmenistan		2	2	2	1	1	1	0	9	2	2	2	1	1	1	0	9	18	5
63.		TPE	Chinese Taipei		0	1	0	0	1	0	1	3	0	1	1	0	0	1	1	4	7	4
64.		TUR	Türkiye		0	0	1	1	0	0	2	4	2	0	1	1	2	1	1	8	12	5
65.		UKR	Ukraine		1	2	1	2	2	0	1	9	0	0	0	0	1	2	0	3	12	6
66.		USA	United States of America		2	1	1	1	1	1	2	9	1	0	1	2	2	0	0	6	15	11
67.		UZB	Uzbekistan		1	2	2	0	2	1	1	9	1	1	1	1	2	1	2	9	18	12
					43	46	54	43	38	35	31	290	37	37	43	33	39	32	20	241	531	316



Dushanbe World Championships Juniors Individuals 2024

Tajikistan, Dushanbe, 2-5 Oct 2024

-60 kg

Men (43)

POOL A

1	IMRANOV Nizami (AZE)	1	IMRANOV N. (AZE)
2	RAMAZANOV Mekan (TKM)	2	RAMAZANOV M. (TKM)
3	PINO BALBIN Jeronimo (COL)	3	PINO BALBIN J. (COL)
4	SAMPINO Francesco (ITA)	4	RAMIREZ J. (MEX)
5	RAMIREZ Juan Pablo (MEX)	5	ALSAIARI A. (KSA)
6	ALSAIARI Abdulrahman (KSA)	6	UNURBAT J. (MGL)
7	UNURBAT Jantsandorj (MGL)	7	ULIANOV V. (IJF)
8	IGNASIAK Ksawery (POL)	8	RAY K. (FRA)
9	ULIANOV Vladimir (IJF)	9	ULIANOV V. (IJF)
10	KARGULOV Aldiyar (KAZ)	10	ULIANOV V. (IJF)
11	RAY Kelvin (FRA)	11	ULIANOV V. (IJF)

POOL B

9	FUKUDA Yamato (JPN)	9	FUKUDA Y. (JPN)
10	LEE Hyeonseung (KOR)	10	LEE H. (KOR)
11	MAHMADOV Sadi (TKJ)	11	SABRAH Y. (EGY)
12	SABRAH Yassin (EGY)	12	TOMANEK J. (SVK)
13	TOMANEK Jozef (SVK)	13	TOMANEK J. (SVK)
14	VISKOVA Nazar (UKR)	14	VISKOVA N. (UKR)
15	AUGUSTO Michel (BRA)	15	AUGUSTO M. (BRA)
16	JORGIC Marko (SRB)	16	AUGUSTO M. (BRA)
17	AGHASYAN Vahe (ARM)	17	AYRE C. (GBR)
18	AYRE Charles (GBR)	18	AYRE C. (GBR)
19	YANG Jonathan (USA)	19	YANG J. (USA)
20	YANG Jonathan (USA)	20	YANG J. (USA)

POOL C

17	ORYNBASSAR Talgat (KAZ)	17	ORYNBASSAR T. (KAZ)
18	OH Sangwoo (KOR)	18	JEREMIC M. (SRB)
19	JEREMIC Matija (SRB)	19	SUN J. (CHN)
20	JATIN (IND)	20	SUN J. (CHN)
21	SUN Jiahao (CHN)	21	OROZMAMATOV A. (KGZ)
22	OROZMAMATOV Adis (KGZ)	22	OROZMAMATOV A. (KGZ)
23	SAGASTEGUI Eduardo (MEX)	23	SAGASTEGUI E. (MEX)
24	AGAMAMMEDOV Ali (TKM)	24	KUDBUDINOV L. (TJK)
25	KUDBUDINOV Loiq (TKJ)	25	KUDBUDINOV L. (TJK)
26	MUNKHJARGAL Tergelsar (MGL)	26	MUNKHJARGAL T. (MGL)
27	IACOMI Vladimir (MDA)	27	MUNKHJARGAL T. (MGL)
28	IACOMI Vladimir (MDA)	28	IACOMI V. (MDA)

POOL D

25	VELAZCO Christopher (USA)	25	VELAZCO C. (USA)
26	MANFERLOTTI Vincenzo (ITA)	26	MANFERLOTTI V. (ITA)
27	WALI Regan Mwandia (KEN)	27	BEKCHYAN A. (ARM)
28	BEKCHYAN Arshak (ARM)	28	BEKCHYAN A. (ARM)
29	ALAOUI CHERIFI Ahmed (MAR)	29	ALAOUI CHERIFI A. (MAR)
30	MURODILLAEV Murodil (UZB)	30	MURODILLAEV M. (UZB)
31	DIJOL Zacharie (FRA)	31	DIJOL Z. (FRA)
32	GHANIZODA Khairullo (TKJ)	32	GHANIZODA K. (TKJ)
33	ROBLES ROLDAN Daniel (ESP)	33	GHANIZODA K. (TKJ)
34	KREMERMANN Daniil (CAN)	34	KREMERMANN D. (CAN)

REPECHAGE

61	YANG J. (USA)	61	YANG J. (USA)
62	ORYNBASSAR T. (KAZ)	62	ORYNBASSAR T. (KAZ)
63	IMRANOV N. (AZE)	63	IMRANOV N. (AZE)
64	MANFERLOTTI V. (ITA)	64	MANFERLOTTI V. (ITA)
65	MURODILLAEV M. (UZB)	65	MURODILLAEV M. (UZB)
66	ORYNBASSAR T. (KAZ)	66	ORYNBASSAR T. (KAZ)

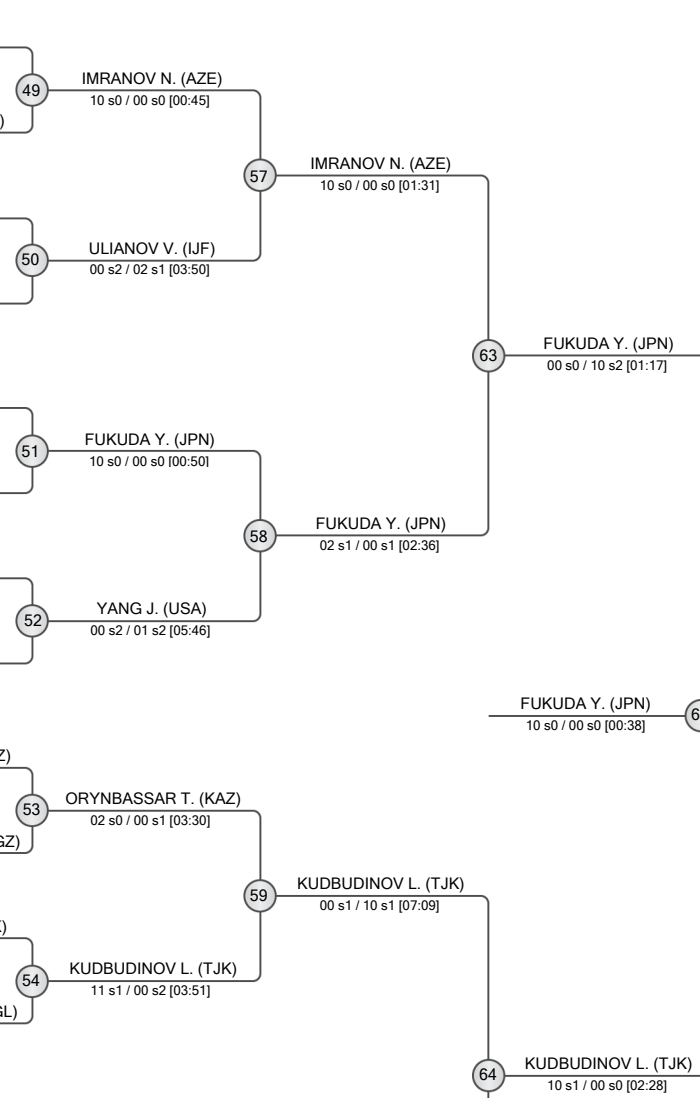

FINAL RESULTS		
1.	FUKUDA Yamato	JPN
2.	KUDBUDINOV Loiq	TKJ
3.	MURODILLAEV Murodil	UZB
3.	ORYNBASSAR Talgat	KAZ
5.	YANG Jonathan	USA
7.	IMRANOV Nizami	AZE
7.	ULIANOV Vladimir	IJF
7.	MANFERLOTTI Vincenzo	ITA





Dushanbe World Championships Juniors Individuals 2024

Tajikistan, Dushanbe, 2-5 Oct 2024

-66 kg

Men (46)

POOL A

1	ACCOGLI Valerio	ITA
2	CHYNYBEKOV Kazybek	KGZ
3	BAATARTSOGT Mungunkhuyag	MGL
4	MUQTADIRI Bobojon	TJK
5	KENTOKU Kairi	JPN
6	ZHUBATKANOV Akylzhan	KAZ
7	SOROCHAN Artem	UKR
8	RENARD Alexis	FRA
9	YOON Hyeonsu	KOR
10	POLIKEVICIUS Simas	LTU
11	YOTOV Boyan	BUL
12	MUSAYEV Mahammad	AZE

1	ACCOGLI V. (ITA)	33	ACCOGLI V. (ITA)
2	CHYNYBEKOV K. (KGZ)	11 s0 / 00 s0 [03:21]	10 s0 / 00 s1 [02:11]
3	KENTOKU K. (JPN)	00 s0 / 11 s0 [01:22]	11 s0 / 00 s0 [02:33]
4	ZHUBATKANOV A. (KAZ)		
5	SOROCHAN A. (UKR)		
6	YOON H. (KOR)	00 s1 / 02 s1 [02:53]	00 s2 / 10 s1 [04:36]
7	POLIKEVICIUS S. (LTU)	01 s1 / 00 s2 [04:00]	
8	MUSAYEV M. (AZE)	00 s1 / 01 s2 [04:00]	

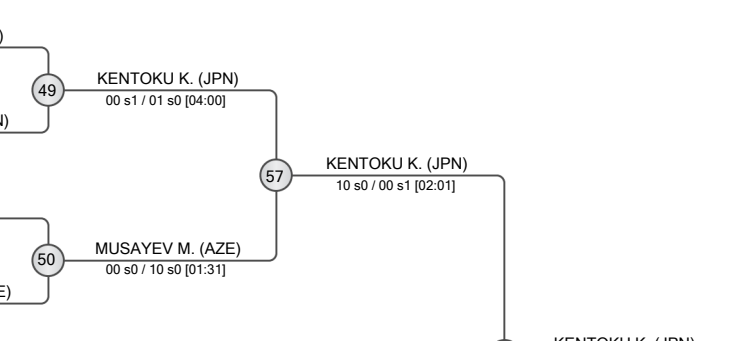

POOL B

9	SANTOS DE OLIVEIRA Iago	BRA
10	BUSYEKA Samson	KEN
11	FRYER Lewis	GBR
12	BALTAZAR Franco	PER
13	KOBETS German	IJF
14	JIANG Ying-Jie	TPE
15	BEKMURODOV Zamohshari	UZB
16	BENLARIBI Ayoub	ALG
17	SHEROV Umar	TJK
18	RAHIMOV Serdar	TKM
19	KOLLAR Sebestyen	HUN

9	SANTOS DE OLIVEIRA I. (BRA)	37	SANTOS DE OLIVEIRA I. (BRA)
10	FRYER L. (GBR)	00 s0 / 10 s0 [00:43]	10 s1 / 00 s2 [05:02]
11	KOBETS G. (IJF)	00 s1 / 10 s0 [02:59]	02 s0 / 01 s0 [02:20]
12	JIANG Y. (TPE)		
13	BEKMURODOV Z. (UZB)		
14	BENLARIBI A. (ALG)	01 s1 / 00 s1 [04:00]	
15	RAHIMOV S. (TKM)	00 s2 / 10 s1 [02:25]	00 s0 / 02 s1 [01:40]
16	KOLLAR S. (HUN)		

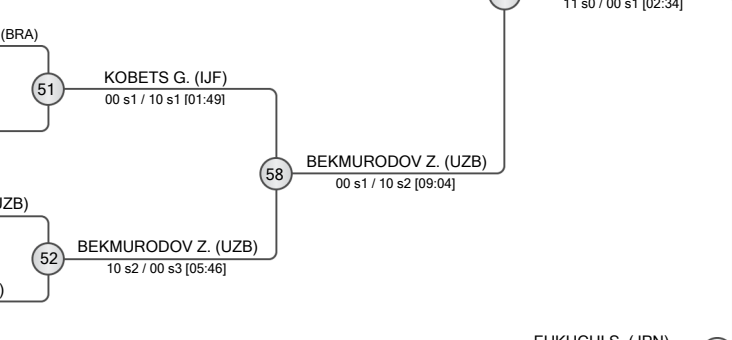

POOL C

17	DE LUCA Alessio	ITA
18	GENOV Kristian	BUL
19	BURK Lenny Linus	GER
20	VITKOUSKI Kiryl	IJF
21	ALHARBI Khalid	KSA
22	TOSHPULATOV Nizomidinxuja	UZB
23	NOEL Kylian	FRA
24	MARTIROSIAN Hahik	UKR
25	RAHIMOV Islam	AZE
26	MAJGUL Rohit Basir	IND
27	FUKUCHI Shuntaro	JPN
28	HEZIL Oussama Abdelhak	ALG

17	DE LUCA A. (ITA)	41	DE LUCA A. (ITA)
18	GENOV K. (BUL)	10 s0 / 01 s1 [02:40]	10 s0 / 00 s0 [00:59]
19	VITKOUSKI K. (IJF)	10 s0 / 00 s1 [01:19]	00 s2 / 10 s0 [02:59]
20	TOSHPULATOV N. (UZB)		
21	NOEL K. (FRA)		
22	MARTIROSIAN H. (UKR)	10 s0 / 01 s3 [03:44]	
23	FUKUCHI S. (JPN)	00 s2 / 10 s1 [03:46]	01 s2 / 00 s2 [04:00]
24	HEZIL O. (ALG)		

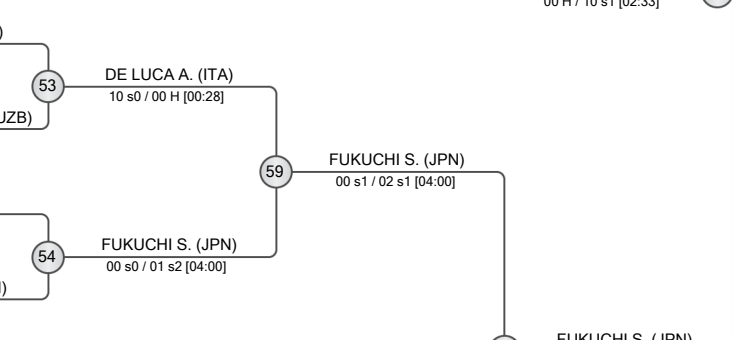

POOL D

25	ICELO Jose	MEX
26	CHRISTODOULIDES Petros	CYP
27	YANG Jacob	USA
28	ALZHANOV Magzhan	KAZ
29	LIMA Ronald	BRA
30	MAITIN Stevan	SUI
31	GABOR Aron	HUN
32	MUHABBATOV Samirsho	TJK
33	MYRADOV Toyly	TKM
34	SHAMURZAEV Almazbek	KGZ
35	ZHANG Shuai	CHN

25	ICELO J. (MEX)	45	YANG J. (USA)
26	YANG J. (USA)	01 s1 / 11 s1 [03:59]	00 s2 / 01 s2 [04:00]
27	ALZHANOV M. (KAZ)	11 s2 / 00 s2 [03:43]	10 s1 / 00 s3 [02:23]
28	MAITIN S. (SUI)		
29	GABOR A. (HUN)		
30	MUHABBATOV S. (TJK)	02 s0 / 00 s0 [01:24]	
31	MYRADOV T. (TKM)	10 s0 / 00 s2 [05:05]	11 s2 / 00 s2 [03:51]
32	ZHANG S. (CHN)		

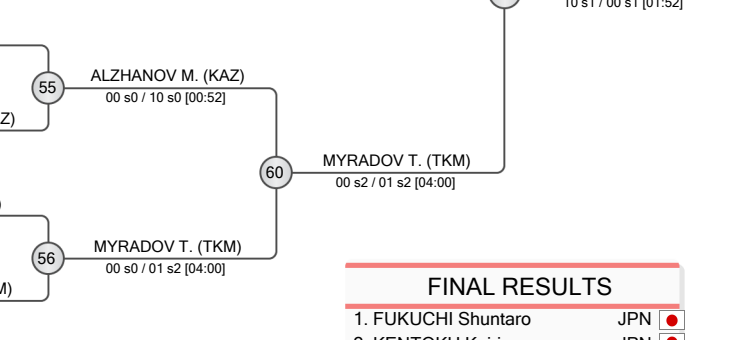

REPECHAGE

MUSAYEV M. (AZE)	61	KOBETS G. (IJF)	00 H / 10 s0 [00:49]
KOBETS G. (IJF)			
DE LUCA A. (ITA)	62	DE LUCA A. (ITA)	02 s0 / 01 s1 [02:25]
ALZHANOV M. (KAZ)			

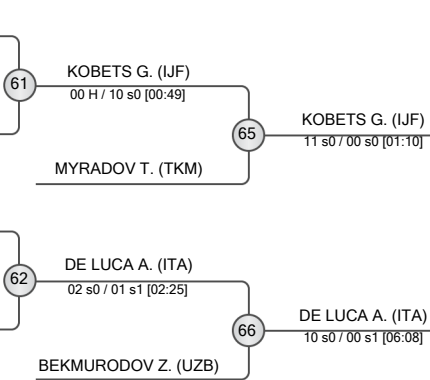

FINAL RESULTS

1. FUKUCHI Shuntaro JPN
2. KENTOKU Kairi JPN
3. KOBETS German IJF
3. DE LUCA Alessio ITA
5. MYRADOV Toyly TKM
5. BEKMURODOV Zamohshari UZB
7. MUSAYEV Mahammad AZE
7. ALZHANOV Magzhan KAZ





Dushanbe World Championships Juniors Individuals 2024

Tajikistan, Dushanbe, 2-5 Oct 2024

-73 kg

Men (54)

POOL A

	GALANDARZADE Vusal	AZE
	OVEZDURDYEV Kemal	TKM
	DUBOVIK Anton	IJF
	TAKEICHI Yusuke	JPN
	BOLDBAATAR Steven	USA
	LEVY Benjamin	GBR
	TOSHEV Khojiakbar	UZB
	BAKIRDINOV Nurmukhammed	KGZ
	JUGDERGARAV Enkhtur	MGL
	ERRBOE Morgan	DEN
	KHALISHVILI Saba	GEO
	BELBELHOUT Abdeslam	ALG
	TOYOSHIMA Kohsei	AUS

1	GALANDARZADE V. (AZE)	33	GALANDARZADE V. (AZE)	
2	DUBOVIK A. (IJF)	10 s0 / 00 s0 [00:29]	49	TAKEICHI Y. (JPN)
3	TAKEICHI Y. (JPN)	00 s1 / 10 s1 [02:21]	34	TAKEICHI Y. (JPN)
4	LEVY B. (GBR)	10 s1 / 00 s0 [00:46]	57	TAKEICHI Y. (JPN)
5	TOSHEV K. (UZB)	01 s2 / 00 s2 [05:32]	50	TOSHEV K. (UZB)
6	JUGDERGARAV E. (MGL)	01 s2 / 00 s1 [07:12]	36	KHALISHVILI S. (GEO)
7	KHALISHVILI S. (GEO)	00 s1 / 11 s1 [02:47]	50	TOSHEV K. (UZB)
8	BELBELHOUT A. (ALG)	01 s2 / 00 s2 [06:20]	35	TOSHEV K. (UZB)
		01 s2 / 00 s2 [04:00]	50	TOSHEV K. (UZB)

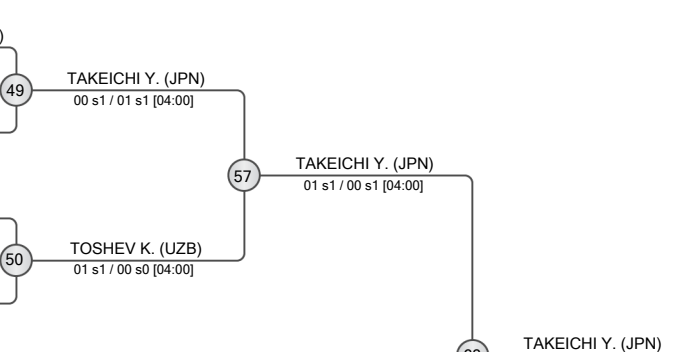

POOL B

	ZELMAN Jerome Assafoua	CIV
	ALSAADI Abdulaziz	KSA
	PARLATI Manuel	ITA
	HERNANDEZ Tomas	CHI
	MERCIER-ROSS Felix	CAN
	KHALIDOV Said-Magomed	UKR
	HARUTYUNYAN Andreas	ARM
	ASADULLOEV Muhiddin	TJK
	MITRU Vlad	MDA
	MASHTAEV Magomed	IJF
	SKERLEV Victor	BUL
	JEAN Peter	FRA
	SZULIK Szymon	POL
	ZHANG Geng	CHN

9	ZELMAN J. (CIV)	37	PARLATI M. (ITA)	
10	PARLATI M. (ITA)	00 s0 / 02 s0 [00:56]	51	PARLATI M. (ITA)
11	HERNANDEZ T. (CHI)	10 s0 / 00 s0 [01:11]	38	HERNANDEZ T. (CHI)
12	KHALIDOV S. (UKR)	10 s1 / 00 s0 [05:14]	39	ASADULLOEV M. (TJK)
13	ASADULLOEV M. (TJK)	10 s0 / 00 s2 [04:24]	40	SZULIK S. (POL)
14	MASHTAEV M. (IJF)	00 s1 / 01 s1 [04:00]	52	ASADULLOEV M. (TJK)
15	SKERLEV V. (BUL)	10 s0 / 00 s0 [01:51]	40	SZULIK S. (POL)
16	SZULIK S. (POL)	01 s1 / 00 s2 [08:59]	52	ASADULLOEV M. (TJK)

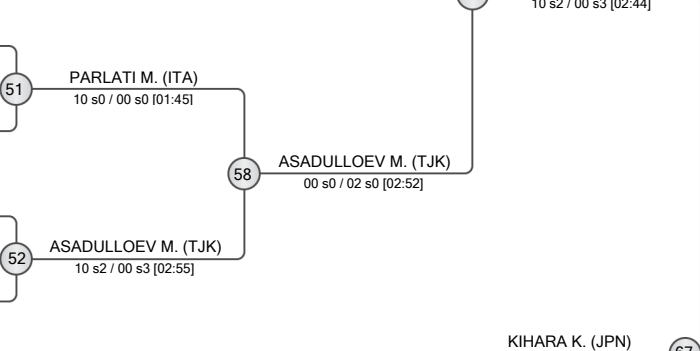

POOL C

	ALMAT Adilet	KAZ
	DEMIREL Ibrahim	TUR
	AKOPJAN Arthur	GER
	RAVSHANOV Mardon	UZB
	KUMAR Arun	IND
	GOGINASHVILI Irakli	GBR
	BERUASHVILI Mate	GEO
	DE OLIVEIRA Guilherme	BRA
	MBURU Alpha	KEN
	TOROSYAN Artak	ARM
	ESPOSITO Fabrizio	ITA
	ANARBEOV Arsen	KGZ
	HARBACHOU Yauheni	IJF
	CROITORU Renat	MDA

17	ALMAT A. (KAZ)	41	ALMAT A. (KAZ)	
18	DEMIREL I. (TUR)	10 s0 / 00 s0 [02:09]	53	RAVSHANOV M. (UZB)
19	RAVSHANOV M. (UZB)	01 s0 / 00 s0 [04:00]	42	RAVSHANOV M. (UZB)
20	BERUASHVILI M. (GEO)	00 s2 / 01 s0 [04:00]	43	DE OLIVEIRA G. (BRA)
21	DE OLIVEIRA G. (BRA)	02 s1 / 01 s1 [02:45]	54	CROITORU R. (MDA)
22	TOROSYAN A. (ARM)	00 s0 / 10 s0 [00:07]	44	CROITORU R. (MDA)
23	ESPOSITO F. (ITA)	10 s0 / 00 s3 [03:43]	54	CROITORU R. (MDA)
24	CROITORU R. (MDA)	00 s0 / 10 s0 [00:39]	54	CROITORU R. (MDA)

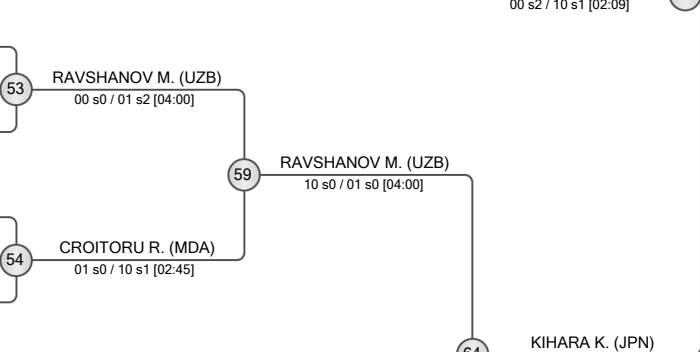

POOL D

	GOSPODINOV Dimitar	BUL
	SHAMURADOV Meylis	TKM
	KIHARA Keito	JPN
	SANCHEZ GARNICA Keiner	COL
	RYBIN Stanislav	ESP
	CRAMP Thomas	AUS
	LAHMOURI Nouh	MAR
	JABBOROV Ilhomiddin	TJK
	IUSUPOV Abubakar	IJF
	PREVE Eliot	FRA
	SUN Jianzhao	CHN
	KIM Yongmin	KOR
	ELKASSAR Youssef	EGY

25	GOSPODINOV D. (BUL)	45	KIHARA K. (JPN)	
26	KIHARA K. (JPN)	00 s0 / 02 s0 [01:24]	55	KIHARA K. (JPN)
27	SANCHEZ GARNICA Keiner	00 s0 / 02 s0 [00:43]	46	RYBIN S. (ESP)
28	CRAMP T. (AUS)	02 s0 / 00 s0 [00:50]	47	IUSUPOV A. (IJF)
29	LAHMOURI N. (MAR)	00 s0 / 01 s2 [05:45]	47	IUSUPOV A. (IJF)
30	IUSUPOV A. (IJF)	00 s0 / 01 s1 [04:00]	56	IUSUPOV A. (IJF)
31	PREVE E. (FRA)	10 s0 / 00 s1 [05:30]	48	KIM Y. (KOR)
32	KIM Y. (KOR)	10 s2 / 00 s2 [05:54]	48	KIM Y. (KOR)

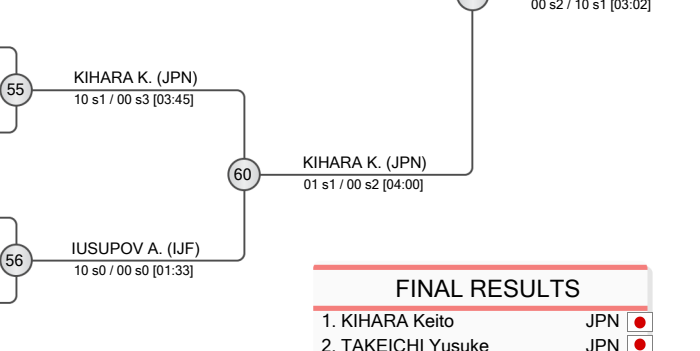

REPECHAGE

TOSHEV K. (UZB)	61	PARLATI M. (ITA)	
PARLATI M. (ITA)	00 s0 / 10 s0 [00:34]	65	RAVSHANOV M. (UZB)
RAVSHANOV M. (UZB)	00 s0 / 10 s0 [00:34]	65	RAVSHANOV M. (UZB)
CROITORU R. (MDA)	62	IUSUPOV A. (IJF)	
IUSUPOV A. (IJF)	00 s0 / 10 s0 [03:37]	66	ASADULLOEV M. (TJK)
ASADULLOEV M. (TJK)	00 s2 / 01 s0 [04:00]	66	ASADULLOEV M. (TJK)

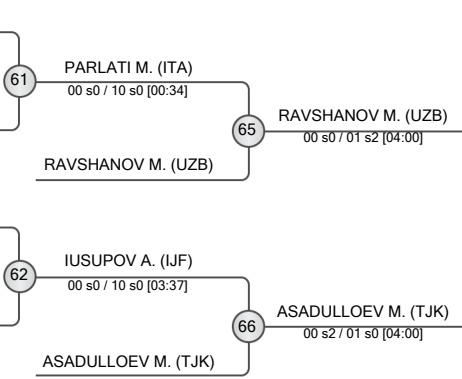

FINAL RESULTS	
1.	KIHARA Keito JPN
2.	TAKEICHI Yusuke JPN
3.	RAVSHANOV Mardon UZB
3.	ASADULLOEV Muhiddin TJK
5.	PARLATI Manuel ITA
7.	TOSHEV Khojiakbar UZB
7.	CROITORU Renat MDA





Dushanbe World Championships Juniors Individuals 2024

Tajikistan, Dushanbe, 2-5 Oct 2024

-81 kg

Men (43)

POOL A

1	LOLADZE Aleksandre (GEO)	LOLADZE A. (GEO)
2	COVI Simone (ITA)	COVI S. (ITA)
3	SOLANKI Aditya (IND)	MUSOEV S. (TJK)
4	KAPSOUROS Marios (GRE)	BIN ABDUL MAJEED A. (MAS)
5	MUSOEV Sunatullo (TJK)	ALMEIDA Luan (BRA)
6	BIN ABDUL MAJEED Amir Daniel (MAS)	BALGABAY Dosbol (KAZ)
7	ALMEIDA Luan (BRA)	NEUMANN Eryk (GBR)
8	KARANJA Daniel Ndung U (KEN)	AYHANOV Agajan (TKM)
9	BALGABAY Dosbol (KAZ)	
10	NEUMANN Eryk (GBR)	
11	AYHANOV Agajan (TKM)	

POOL B

9	RODRIGUEZ Dominic (USA)	RODRIGUEZ D. (USA)
10	VALCHEV Emil (BUL)	RUTOVIC B. (SRB)
11	RUTOVIC Boris (SRB)	YUSUFZODA M. (TJK)
12	NIELZIEV Taras (UKR)	ABOHASHIM A. (EGY)
13	YUSUFZODA Muhammad (TJK)	JAVAKHISHVILI Luka (GEO)
14	ABOHASHIM Ammar (EGY)	ZULYS Algirdas (LTU)
15	JAVAKHISHVILI Luka (GEO)	TURLUEV A. (IJF)
16	ZULYS Algirdas (LTU)	TARKOWSKI Fabryciusz (POL)
17	GRIBINET Ciprian (MDA)	
18	TURLUEV Akhmed (IJF)	
19	TARKOWSKI Fabryciusz (POL)	

POOL C

17	TSURKAN Igor (UKR)	TSURKAN I. (UKR)
18	PARHIZGAR Elyas (IRI)	PARHIZGAR E. (IRI)
19	KUMISBAY Azat (KAZ)	KUMISBAY A. (KAZ)
20	NERGUI Jangarai (MGL)	PILECKAS Aidas (LTU)
21	PILECKAS Aidas (LTU)	KANATBEKOV Erzhan (KGZ)
22	KANATBEKOV Erzhan (KGZ)	WANG Jiangnan (CHN)
23	WANG Jiangnan (CHN)	MIHALOVSV Ivans (LAT)
24	MIHALOVSV Ivans (LAT)	NASCHCHO Issa (AUT)
25	NASCHCHO Issa (AUT)	ARI Emir Selim (TUR)
26	ARI Emir Selim (TUR)	

POOL D

25	SHUKUROV Suleyman (AZE)	SHUKUROV S. (AZE)
26	ABDUJALILZODA Aminjon (TJK)	SIMIN M. (SRB)
27	SIMIN Mihajlo (SRB)	ZARAGKAS Aris (GRE)
28	ZARAGKAS Aris (GRE)	OCHI Keishin (AUS)
29	OCHI Keishin (AUS)	KIM Seungmin (KOR)
30	KIM Seungmin (KOR)	DE LANGE Joshua (NED)
31	DE LANGE Joshua (NED)	PEREZ RUIZ John (COL)
32	PEREZ RUIZ John (COL)	SHARAHILI Ibrahim (KSA)
33	SHARAHILI Ibrahim (KSA)	AKITA Haru (JPN)
34	AKITA Haru (JPN)	DAVIES Luke (GBR)
35	DAVIES Luke (GBR)	

REPECHAGE

61	YUSUFZODA M. (TJK)	SHUKUROV S. (AZE)
62	KUMISBAY A. (KAZ)	DAVIES L. (GBR)
63	YUSUFZODA M. (TJK)	SHUKUROV S. (AZE)
64	KUMISBAY A. (KAZ)	MUSOEV S. (TJK)

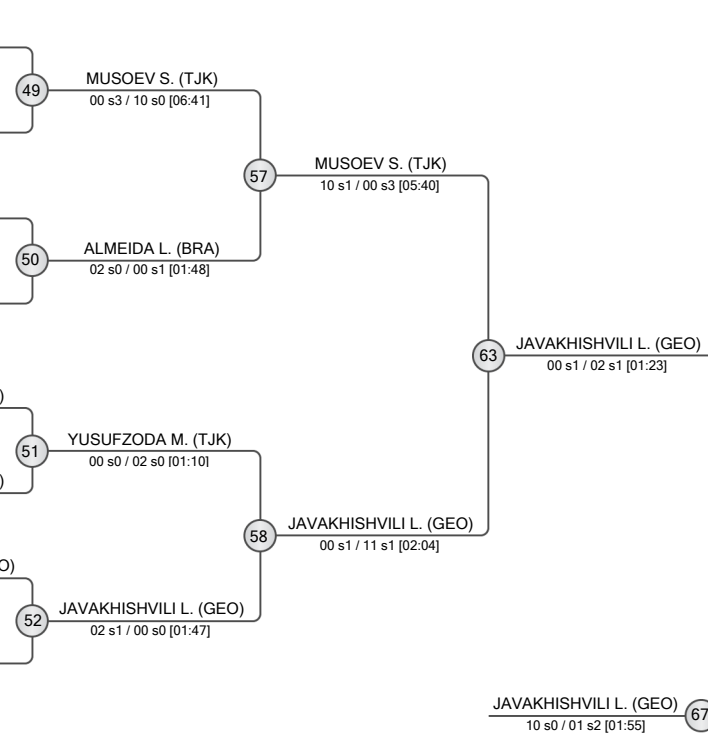

FINAL RESULTS		
1.	JAVAKHISHVILI Luka	GEO
2.	WANG Jiangnan	CHN
3.	SHUKUROV Suleyman	AZE
3.	KUMISBAY Azat	KAZ
5.	YUSUFZODA Muhammad	TJK
7.	ALMEIDA Luan	BRA
7.	DE LANGE Joshua	NED





Dushanbe World Championships Juniors Individuals 2024

Tajikistan, Dushanbe, 2-5 Oct 2024

-90 kg

Men (38)

POOL A

🇯🇵	KAWABATA Komei	JPN	1
🇹🇯	GANIEV Musokhon	TJK	2
🇺🇰	YUDANOV Nikita	UKR	3
🇰🇷	CHOI Jaemin	KOR	4
🇰🇬	SANSYZBEKOV Artur	KGZ	5
🇺🇿	SHARIPOV Shakhzodxuja	UZB	6
🇮🇷	CHOOPAN Amir Abbas	IRI	7
🇦🇷	KOTSOEV Aslan	AZE	8
🇷🇴	SIBISAN Alexandru	ROU	9
🇪🇸	MARTINEZ COIN Marcos	ESP	10

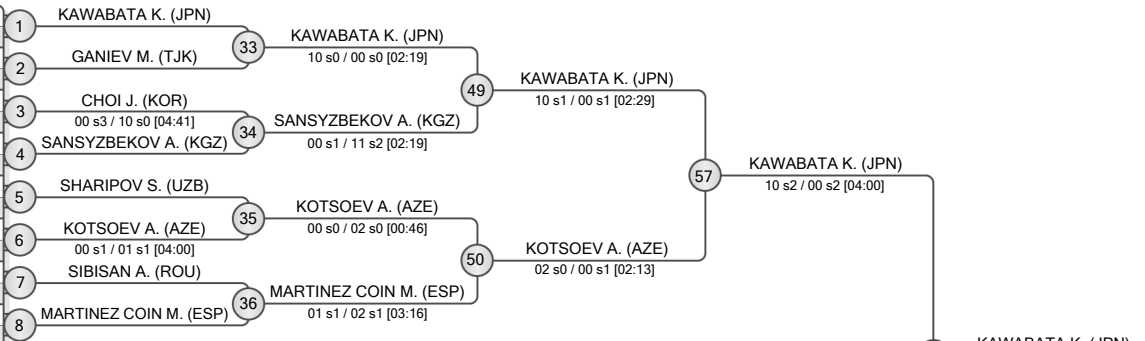

POOL B

🇵🇱	WASIKOWSKI Michal	POL	9
🇮🇯	KUNIZHEV Rolan	IJF	10
🇬🇪	KOBERIDZE Tamaz	GEO	11
🇮🇹	OWUSU Henry Owusu Asare	ITA	12
🇩🇪	PACARIZ Armin	GER	13
🇳🇱	DEN HARTOG Floris	NED	14
🇰🇿	BIRZHANOV Askar	KAZ	15
🇹🇵	CHEN Peng-Yu	TPE	16
🇪🇬	HOSSAM Hazem	EGY	17

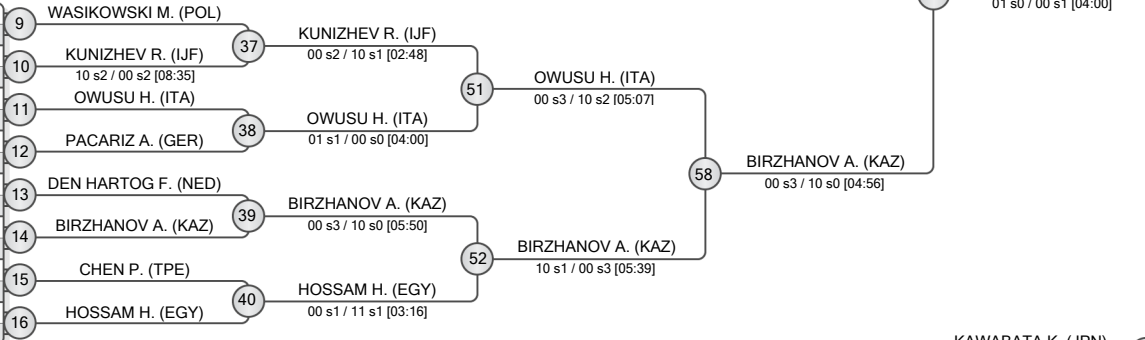

POOL C

🇷🇸	RADULJ Milijan	SRB	17
🇺🇿	SAMANOV Alisher	UZB	18
🇪🇬	ABDELAAL Aly	EGY	19
🇧🇷	BARBOSA Jesse	BRA	20
🇱🇺	WELTER Micha	LUX	21
🇲🇩	GHIMBOVSCHI Vadim	MDA	22
🇰🇬	POLTUSHEV Daut	KGZ	23
🇮🇹	MINCINESI Cristiano	ITA	24
🇺🇸	NYZHNYK Oleksandr	USA	25
🇨🇳	YAN Boyin	CHN	26

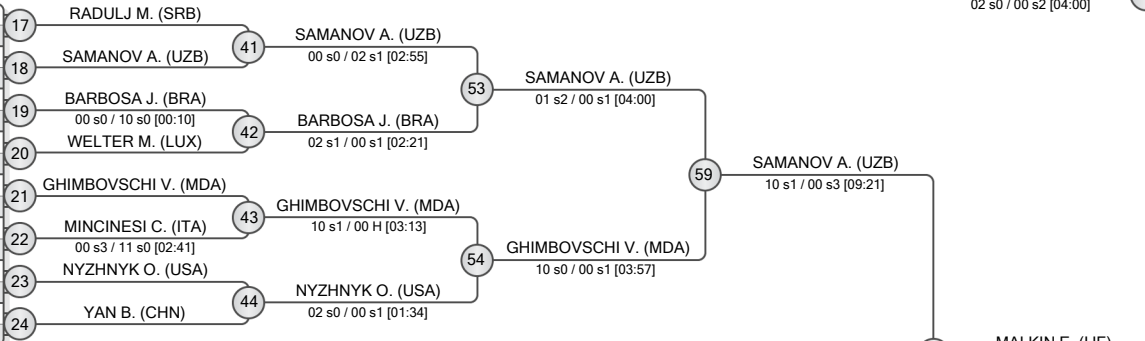

POOL D

🇸🇯	BOLDYRIEV Oleksii	SLO	25
🇫🇷	CHERNYSHENKO Ivan	FRA	26
🇹🇰	ACHYLDYYEV Mamedaly	TKM	27
🇮🇯	MALKIN Egor	IJF	28
🇦🇷	SHAMIL Tuncay	AZE	29
🇺🇰	KUTENKOV Ivan	UKR	30
🇹🇯	KARIMZODA Muzamir	TJK	31
🇭🇺	KISS Levente	HUN	32
🇨🇷	BUTIJER Borna	CRO	33

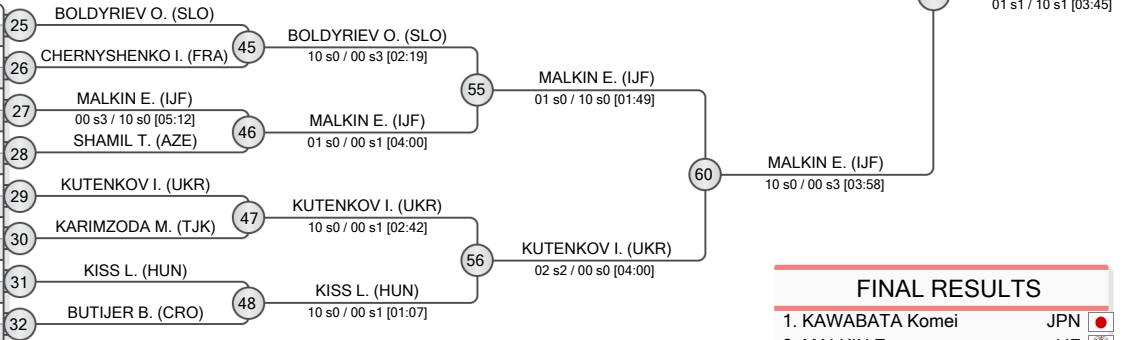

REPECHAGE

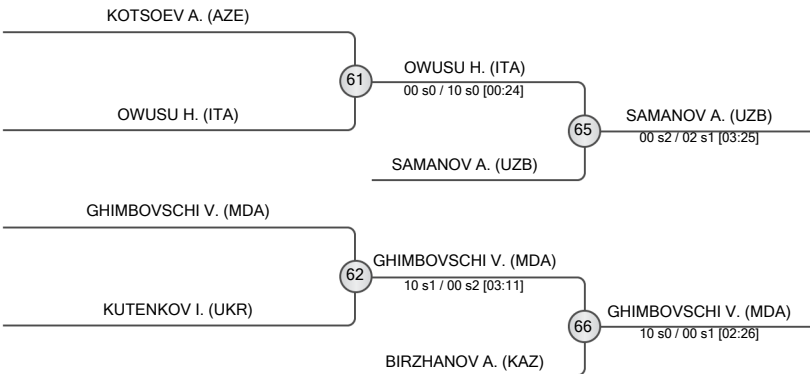

FINAL RESULTS		
1.	KAWABATA Komei	JPN 🇯🇵
2.	MALKIN Egor	IJF 🇮🇯
3.	SAMANOV Alisher	UZB 🇺🇿
3.	GHIMBOVSCHI Vadim	MDA 🇲🇩
5.	OWUSU Henry Owusu Asare	ITA 🇮🇹
7.	BIRZHANOV Askar	KAZ 🇰🇿
7.	KOTSOEV Aslan	AZE 🇦🇷
7.	KUTENKOV Ivan	UKR 🇺🇰





Dushanbe World Championships Juniors Individuals 2024

Tajikistan, Dushanbe, 2-5 Oct 2024

-100 kg

Men (35)

POOL A

1	SCHELL Joes (NED)	33	BAGHIROV A. (AZE)	00 s0 / 02 s0 [03:04]
2	BAGHIROV Azhdar (AZE)	33	BAGHIROV A. (AZE)	00 s0 / 02 s0 [03:04]
3	MARTINOVIC Andrija (MNE)	34	GAGADZE G. (GEO)	00 s0 / 11 s1 [02:22]
4	GAGADZE Gaga (GEO)	34	GAGADZE G. (GEO)	00 s0 / 11 s1 [02:22]
5	KRAMER Andre (BRA)	35	KRAMER A. (BRA)	10 s0 / 00 s1 [01:49]
6	RAKHOLIYA Krish Alpeshbhai (IND)	35	KRAMER A. (BRA)	10 s0 / 00 s1 [01:49]
7	MAJANOV Baymyrat (TKM)	36	LAKOS M. (HUN)	02 s0 / 00 s1 [01:55]
8	PARK Semin (KOR)	36	LAKOS M. (HUN)	00 s1 / 11 s0 [01:39]
	LAKOS Mate (HUN)			

POOL B

9	BORDIN Maxence (FRA)	37	BORDIN M. (FRA)	10 s1 / 00 s3 [03:33]
10	AMARO CABELLO Roman (ESP)	37	BORDIN M. (FRA)	10 s1 / 00 s3 [03:33]
11	AHMED Mohamed (EGY)	38	ARSENIE R. (ROU)	00 s1 / 10 s2 [03:28]
12	ARSENIE Rares (ROU)	38	ARSENIE R. (ROU)	00 s1 / 10 s2 [03:28]
13	SODIKOV Mukhammadsodik (UZB)	39	SODIKOV M. (UZB)	02 s1 / 00 s2 [02:26]
14	BASCHIN Jannis (GER)	39	SODIKOV M. (UZB)	02 s1 / 00 s2 [02:26]
15	SCHEFFEL Oliver (SVK)	40	MALAEV M. (TJK)	00 s3 / 10 s2 [04:11]
16	CHA Ning (CHN)	40	MALAEV M. (TJK)	00 s3 / 10 s2 [04:11]
	MALAEV Muhsin (TJK)			

POOL C

17	BULAJA Milan (SRB)	41	BULAJA M. (SRB)	10 s0 / 01 s0 [02:27]
18	PETRE Bogdan (ROU)	41	BULAJA M. (SRB)	10 s0 / 01 s0 [02:27]
19	SINGH Maanvender (IND)	42	KUBIAK D. (POL)	00 s2 / 01 s2 [04:00]
20	NIGHTINGALE Axel (AUS)	42	KUBIAK D. (POL)	00 s2 / 01 s2 [04:00]
21	KUBIAK Damian (POL)	43	MEKHOUKH F. (FRA)	10 s1 / 01 s3 [03:38]
22	MEKHOUKH Fares (FRA)	43	MEKHOUKH F. (FRA)	10 s1 / 01 s3 [03:38]
23	GUIMARAES Matheus (BRA)	44	EKVTIMISHVILI L. (GEO)	01 s1 / 00 s2 [08:20]
24	EKVTIMISHVILI Luka (GEO)	44	EKVTIMISHVILI L. (GEO)	01 s1 / 00 s2 [08:20]
	LIUBIMOVSKI Daniel (USA)			

POOL D

25	VARES Jakob (EST)	45	VARES J. (EST)	10 s0 / 00 s1 [04:50]
26	LIM Seongmin (KOR)	45	VARES J. (EST)	10 s0 / 00 s1 [04:50]
27	MIKI Nozomu (JPN)	46	MIKI N. (JPN)	02 s0 / 00 s0 [02:37]
28	LHOTZKY Frantisek (CZE)	46	MIKI N. (JPN)	02 s0 / 00 s0 [02:37]
29	EDERER Pierre (GER)	47	ABDURAKHMONOV P. (TJK)	00 s0 / 10 s0 [01:11]
30	ABDURAKHMONOV Parviz (TJK)	47	ABDURAKHMONOV P. (TJK)	00 s0 / 10 s0 [01:11]
31	KENDERESI Peter (HUN)	48	NIKSERESHT A. (IRI)	00 s0 / 02 s1 [03:41]
32	NIKSERESHT Ali Reza (IRI)	48	NIKSERESHT A. (IRI)	00 s0 / 02 s1 [03:41]

REPECHAGE

61	ARSENIE R. (ROU)	65	MEKHOUKH F. (FRA)	00 s0 / 02 s0 [00:56]
	ARSENIE R. (ROU)		MEKHOUKH F. (FRA)	
			MEKHOUKH F. (FRA)	00 s7 / 10 s0 [03:21]
62	NIKSERESHT A. (IRI)	66	BAGHIROV A. (AZE)	00 s1 / 01 s1 [04:00]
	NIKSERESHT A. (IRI)		BAGHIROV A. (AZE)	
			BAGHIROV A. (AZE)	00 s3 / 11 s2 [03:53]

FINAL RESULTS

- SODIKOV Mukhammadsodik (UZB)
- MIKI Nozomu (JPN)
- MEKHOUKH Fares (FRA)
- BAGHIROV Azhdar (AZE)
- ARSENIE Rares (ROU)
- NIKSERESHT Ali Reza (IRI)
- LAKOS Mate (HUN)
- KUBIAK Damian (POL)





Dushanbe World Championships Juniors Individuals 2024

Tajikistan, Dushanbe, 2-5 Oct 2024

+100 kg

Men (31)

POOL A

	MESSE A BESSONG John	CAN
	KADZAEV Arsen	IJF
	EDE Daniel	GBR
	RAFIKOV Fazliddin	UZB
	USTOPIROV Farahmand	TJK
	BAEK Dusan	KOR
	LIN Dong	CHN

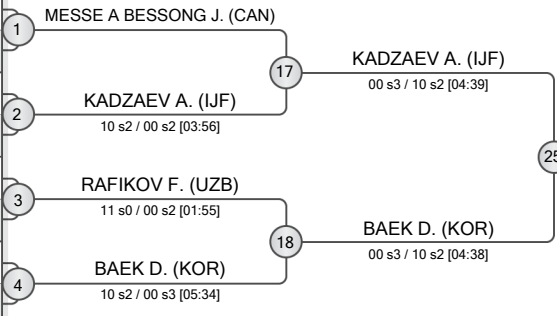

POOL B

	NASIBOV Kanan	AZE
	BIGANASHVILI Tamaz	GEO
	RAHUL Rahul	IND
	ERGIN Recep	TUR
	DOBRE Darius	ROU
	AKOJYAN Armen	USA
	MOVAHED Amir Abbas	IRI
	HUANG Cheng-Wei	TPE

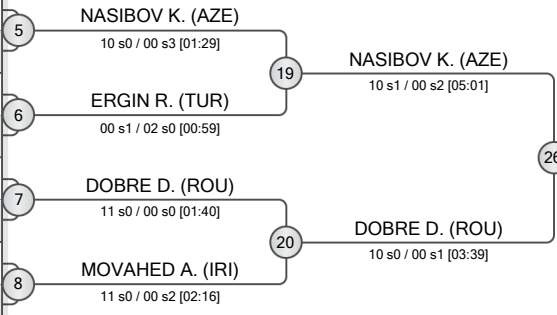

POOL C

	ZHOLDOSHKAZIEV Emirkhan	KGZ
	HATAKEYAMA Gai	JPN
	BATCHAEV Denis	IJF
	OMELCHENKO Yaroslav	UKR
	NURTILEPULY Zhantilek	KAZ
	OCHIR Gereltbayar	MGL
	VIJAYRAN Yash	IND
	SEMENENKO Alex	USA

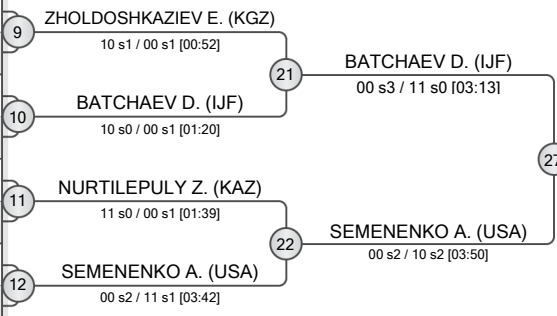

POOL D

	TATAROGLU Ibrahim	TUR
	MASKOU Mikita	IJF
	SUHA Mortaza	GER
	COELHO Andrey	BRA
	KARDAVA Saba	GEO
	LOU Yingjie	CHN
	MAZLOOMLAPVANDANI Mohammadmahdi	IRI
	TABAROV Ahmad	TJK

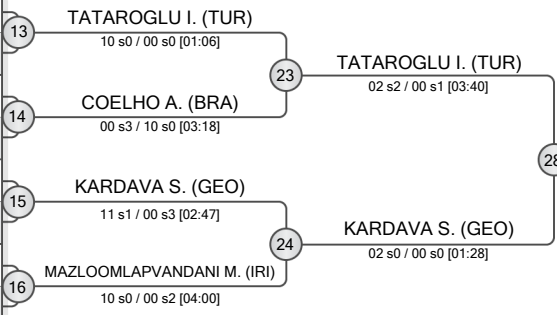

REPECHAGE

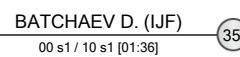
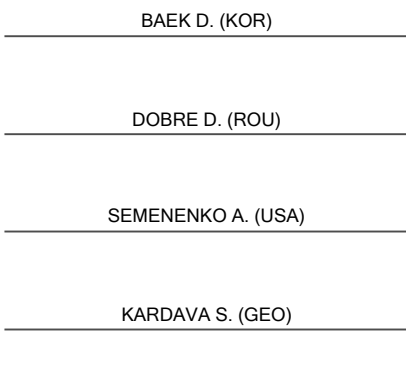

FINAL RESULTS	
1. BATCHAEV Denis	IJF
2. NASIBOV Kanan	AZE
3. TATAROGLU Ibrahim	TUR
3. KARDAVA Saba	GEO
5. DOBRE Darius	ROU
5. KADZAEV Arsen	IJF
7. BAEK Dusan	KOR
7. SEMENENKO Alex	USA





Dushanbe World Championships Juniors Individuals 2024

Tajikistan, Dushanbe, 2-5 Oct 2024

-48 kg

Women (37)

POOL A

1	ALIYEVA Konul (AZE)	ALIYEVA K. (AZE)
2	SIBILLE Victoria (BEL)	SIBILLE V. (BEL)
3	DUDINA Kristina (IJF)	DUDINA K. (IJF)
4	KURBANOVA Kurbanay (TKM)	ABDUALI T. (KAZ)
5	HAYDAROVA Laziza (UZB)	HAYDAROVA L. (UZB)
6	HUI Xinran (CHN)	HUI X. (CHN)
7	ERTEM Zilan (TUR)	ERTEM Z. (TUR)
8	MAZZOLA Sofia (ITA)	MAZZOLA S. (ITA)

POOL B

9	BOGDAN Laura (ROU)	BOGDAN L. (ROU)
10	JUMAEVA Zuhai (TJK)	QUACH H. (CAN)
11	QUACH Heidi (CAN)	RODONAIA J. (GEO)
12	RODONAIA Julieta (GEO)	SZELECZKI S. (HUN)
13	SZELECZKI Szabina (HUN)	DIAZ HERNANDEZ A. (ESP)
14	DIAZ HERNANDEZ Aitana (ESP)	FILKINA L. (IJF)
15	LAU Wan Yee (HKG)	FILKINA L. (IJF)
16	FILKINA Lana (IJF)	ASAKEEVA L. (KGZ)
17	ASAKEEVA Luiza (KGZ)	JUNG S. (KOR)
18	JUNG Su Jin (KOR)	JUNG S. (KOR)

POOL C

19	HO Lok Yi (HKG)	HO L. (HKG)
20	HARVOLGYI Tamara (HUN)	HARVOLGYI T. (HUN)
21	MAKEYENKA Aryna (IJF)	MAKEYENKA A. (IJF)
22	VALERIANI Rebecca (ITA)	VALERIANI R. (ITA)
23	SHAW Summer (GBR)	SHAW S. (GBR)
24	YULDASHBEKOVA Sabina (KAZ)	YULDASHBEKOVA S. (KAZ)
25	SIMRAN Simran (IND)	JAMSRAN A. (MGL)
26	JAMSRAN Anudari (MGL)	ROZIKZODA R. (TJK)
27	ROZIKZODA Raihonai (TJK)	

POOL D

29	ANNIS Morgane (FRA)	ANNIS M. (FRA)
30	TURMEL Marie-Lune (CAN)	TURMEL M. (CAN)
31	YOSHINO Sachiyo (JPN)	YOSHINO S. (JPN)
32	BEORLEGUI OSES Marta (ESP)	DOGRUYOL B. (TUR)
33	DOGRUYOL Begumnaz (TUR)	RIADI N. (MAR)
34	RIADI Nohade (MAR)	RAMOS K. (USA)
35	RAMOS Kelani (USA)	RIBEIRO C. (BRA)
36	RIBEIRO Clarice (BRA)	RIBEIRO C. (BRA)
37	KANDYMOVA Dilara (TKM)	KANDYMOVA D. (TKM)

REPECHAGE

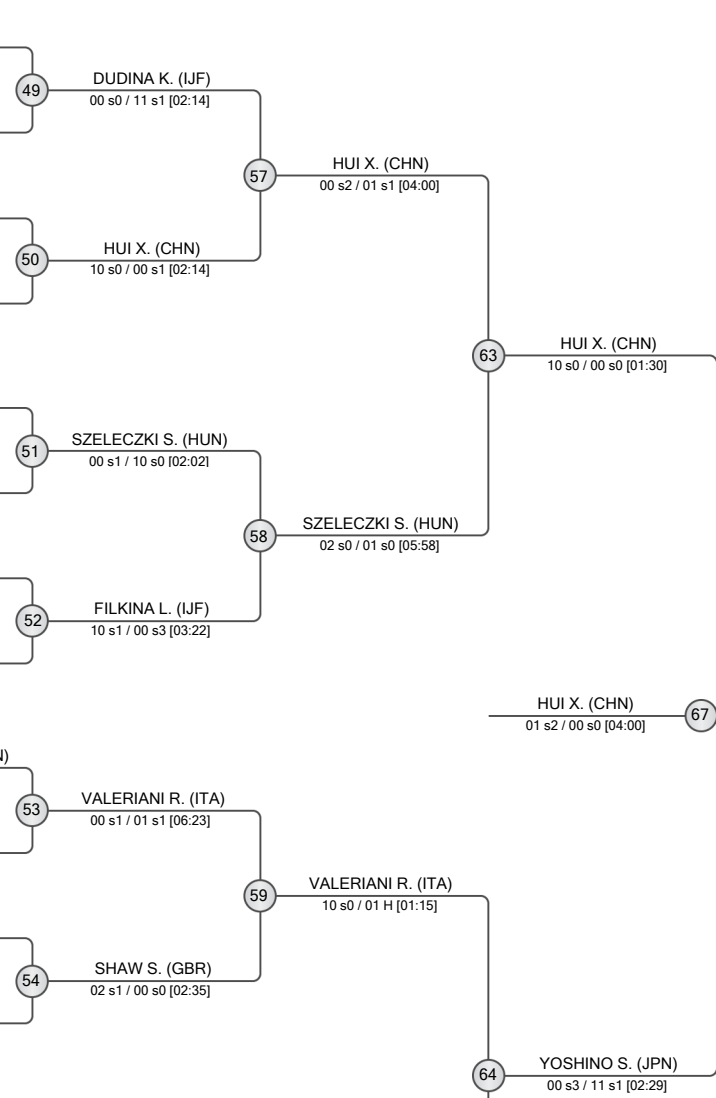
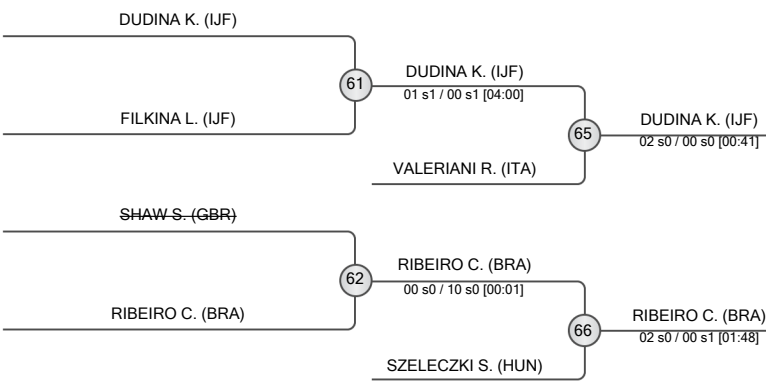

FINAL RESULTS	
1.	HUI Xinran (CHN)
2.	YOSHINO Sachiyo (JPN)
3.	DUDINA Kristina (IJF)
3.	RIBEIRO Clarice (BRA)
5.	VALERIANI Rebecca (ITA)
5.	SZELECZKI Szabina (HUN)
7.	FILKINA Lana (IJF)
7.	SHAW Summer (GBR)





Dushanbe World Championships Juniors Individuals 2024

Tajikistan, Dushanbe, 2-5 Oct 2024

-52 kg

Women (37)

POOL A

1	SCIACOVELLI Micaela (ITA)	SCIACOVELLI M. (ITA)
2	SHEN Yi-Hsi (TPE)	SHEN Y. (TPE)
3	ZHANG Yuanli (CHN)	ZHANG Y. (CHN)
4	KIM Minjeong (KOR)	OI I. (JPN)
5	OI Iroha (JPN)	OI I. (JPN)
6	FINESTRONE Ilaria (ITA)	FINESTRONE I. (ITA)
7	GAZAKOVA Arina (TKM)	GAZAKOVA A. (TKM)
8	VALIYEVA Aydan (AZE)	VALIYEVA A. (AZE)
	GEORGIEVA Denitsa (BUL)	GEORGIEVA D. (BUL)

POOL B

9	RODRIGUES Rafaela (BRA)	RODRIGUES R. (BRA)
10	MECKLENBURG Tabea Nika (GER)	MECKLENBURG T. (GER)
11	GOMEZ ANTONA Laura (ESP)	GOMEZ ANTONA L. (ESP)
12	CHOPADE Shradha Kadubal (IND)	CHOPADE S. (IND)
13	MAMIRA Luca (HUN)	MAMIRA L. (HUN)
14	CUQ Pauline (FRA)	MYAGMARSUREN N. (MGL)
15	MYAGMARSUREN Nandin-Erdene (MGL)	MYAGMARSUREN N. (MGL)
16	QURBONZODA Madina (TJK)	QURBONZODA M. (TJK)
	YEREZHEPOVA Aruzhan (KAZ)	YEREZHEPOVA A. (KAZ)

POOL C

17	NISAVIC Nikolina (SRB)	NISAVIC N. (SRB)
18	DJERIOU Lena (GER)	DJERIOU L. (GER)
19	BAYANMUNKH Uranzaya (MGL)	BAYANMUNKH U. (MGL)
20	CATANA Luciana (ROU)	CATANA L. (ROU)
21	BEATON Evelyn (CAN)	BEATON E. (CAN)
22	ZAKHAROVA Daria (IJF)	ZAKHAROVA D. (IJF)
23	NOOR Malaika (PAK)	ARCONES MONTENEGRO M. (ESP)
24	ARCONES MONTENEGRO Maria Del Rocío (ESP)	HUH M. (KOR)
	HUH Mio (KOR)	HUH M. (KOR)

POOL D

25	KLIMCZAK Kinga (POL)	KLIMCZAK K. (POL)
26	RIVAS Driulys (PER)	RIVAS D. (PER)
27	KOZHOMBERDIEVA Sabira (KGZ)	NOSHO S. (JPN)
28	NOSHO Senju (JPN)	NOSHO S. (JPN)
29	AKHMATOVA Mukhayyo (UZB)	AKHMATOVA M. (UZB)
30	KLAUS-STERNWIESER Carina (AUT)	KLAUS-STERNWIESER C. (AUT)
31	POULANGE Alyssia (FRA)	POULANGE A. (FRA)
32	GADASHOVA Khadizha (AZE)	GADASHOVA K. (AZE)
	NURITDINOVA Maya (TKM)	NURITDINOVA M. (TKM)
	KAIRAT Ayaulym (KAZ)	KAIRAT A. (KAZ)

REPECHAGE

61	VALIYEVA A. (AZE)	VALIYEVA A. (AZE)
62	POULANGE A. (FRA)	POULANGE A. (FRA)
63	RODRIGUES R. (BRA)	RODRIGUES R. (BRA)
64	NOSHO S. (JPN)	NOSHO S. (JPN)
65	HUH M. (KOR)	HUH M. (KOR)
66	POULANGE A. (FRA)	POULANGE A. (FRA)

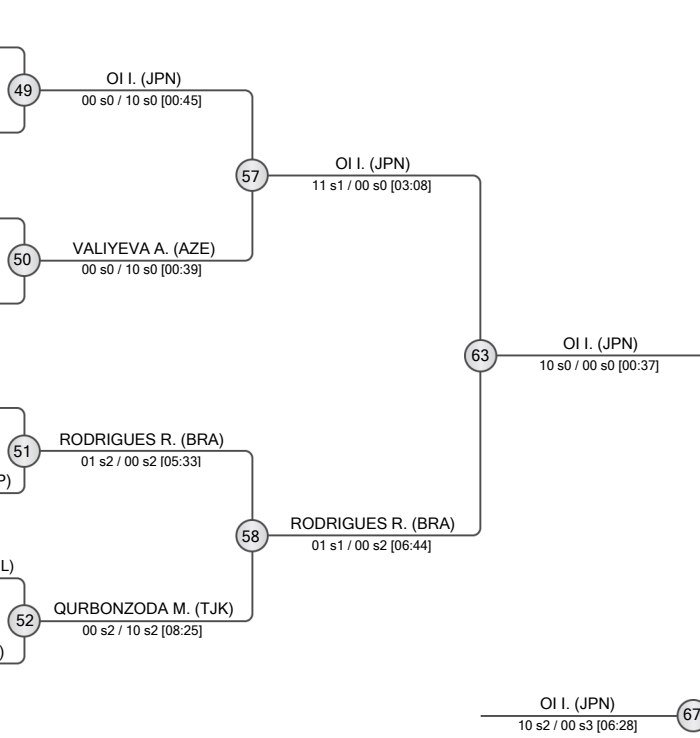

FINAL RESULTS		
1.	OI Iroha	JPN
2.	NOSHO Senju	JPN
3.	HUH Mio	KOR
3.	POULANGE Alyssia	FRA
5.	VALIYEVA Aydan	AZE
7.	RODRIGUES Rafaela	BRA
7.	QURBONZODA Madina	TJK
7.	BAYANMUNKH Uranzaya	MGL





Dushanbe World Championships Juniors Individuals 2024

Tajikistan, Dushanbe, 2-5 Oct 2024

-57 kg

Women (43)

POOL A

1	REIS Bianca (BRA)	33	REIS B. (BRA)
2	SHIRAKANE Mio (JPN)	01 s0 / 00 s2 [05:23]	SHIRAKANE M. (JPN)
3	NDIAYE Binta (SUI)	00 s0 / 10 s0 [00:00]	RIEGERT H. (GER)
4	PARDAYEVA Maysa (TKM)	00 s0 / 01 s0 [04:00]	SANTIAGO SANTANA O. (ESP)
5	RIEGERT Helene (GER)	00 s0 / 01 s0 [04:00]	SANTIAGO SANTANA O. (ESP)
6	SANTIAGO SANTANA Odalis (ESP)	01 s1 / 00 s0 [04:38]	DE CARVALHO A. (FRA)
7	DE CARVALHO Alya (FRA)	01 s1 / 00 s0 [04:38]	DE CARVALHO A. (FRA)
8	MACIAS Jasmine (USA)	00 s0 / 02 s0 [01:58]	TAO Y. (CHN)
9	NISAVIC Kristina (SRB)	00 s0 / 02 s0 [01:11]	TAO Y. (CHN)
10	NISAVIC Kristina (SRB)	00 s0 / 02 s0 [01:11]	TAO Y. (CHN)
11	GAGNON Laurence (CAN)	00 s0 / 02 s0 [01:11]	TAO Y. (CHN)
12	TAO Yuying (CHN)	00 s0 / 02 s0 [01:11]	TAO Y. (CHN)

POOL B

9	ALIZADA Fidan (AZE)	37	ALIZADA F. (AZE)
10	TSIKLAURI Nino (GEO)	11 s0 / 00 s0 [00:58]	ALIZADA F. (AZE)
11	JENMAN Charlotte (GBR)	10 s0 / 00 s0 [01:56]	ALIZADA F. (AZE)
12	KAN Aleksandra (TJK)	11 s1 / 00 s0 [02:50]	KAN A. (TJK)
13	KARADAG Aysenur (TUR)	10 s1 / 00 s2 [03:38]	TERRANOVA M. (ITA)
14	NAVROOP Navroop (IND)	10 s1 / 00 s2 [03:38]	TERRANOVA M. (ITA)
15	TERRANOVA Michela (ITA)	10 s0 / 00 s2 [03:00]	TOLEA V. (ROU)
16	OYUNGEREL Oyunchimeg (MGL)	00 H / 10 s0 [01:11]	SIENNICKA K. (POL)
17	AMANTUROVA Kyial (KGZ)	00 s2 / 10 s1 [03:36]	SIENNICKA K. (POL)
18	TOLEA Vanessa (ROU)	00 s2 / 10 s1 [03:36]	SIENNICKA K. (POL)
19	SIENNICKA Karolina (POL)	00 s2 / 10 s1 [03:36]	SIENNICKA K. (POL)

POOL C

17	COMANCHE Beatriz (BRA)	41	COMANCHE B. (BRA)
18	KHANJARBEKOVA Rahmiya (TJK)	10 s1 / 00 s3 [05:14]	COMANCHE B. (BRA)
19	NAM Yuri (KOR)	01 s1 / 00 s1 [04:00]	COMANCHE B. (BRA)
20	NONE Grace (KEN)	00 s1 / 10 s0 [01:16]	VEG L. (HUN)
21	VEG Luca (HUN)	00 s1 / 10 s0 [01:16]	VEG L. (HUN)
22	CHMIELEWSKA Kinga (POL)	10 s0 / 00 s1 [02:34]	CHMIELEWSKA K. (POL)
23	TOSHKOVA Catherine (CAN)	01 s1 / 11 s0 [05:58]	POLLHEIMER M. (SUI)
24	POLLHEIMER Mirja (SUI)	00 s0 / 01 s1 [04:00]	SAEZ HEVIA A. (ESP)
25	BU-QAHOSS Fatena (QAT)	00 s0 / 01 s1 [04:00]	SAEZ HEVIA A. (ESP)
26	SAEZ HEVIA Adriana (ESP)	00 s0 / 11 s0 [00:58]	SAEZ HEVIA A. (ESP)

POOL D

25	HONDA Riko (JPN)	45	HONDA R. (JPN)
26	MUKHINA Olga (IJF)	01 s1 / 00 s2 [05:29]	HONDA R. (JPN)
27	BOCHKOVA Despina (UZB)	00 H / 10 s0 [01:10]	TERBISH A. (MGL)
28	TERBISH Ariunzaya (MGL)	01 s0 / 00 s2 [04:00]	TERBISH A. (MGL)
29	ZHOLDOSHEVA Zhanar (KGZ)	10 s1 / 00 s1 [02:33]	ABDIROVA D. (KAZ)
30	ABDIROVA Dana (KAZ)	10 s1 / 00 s1 [02:33]	ABDIROVA D. (KAZ)
31	ORAZNYAZOVA Medine (TKM)	00 s0 / 10 s0 [00:19]	LINK C. (GBR)
32	LINK Chloe (GBR)	00 s0 / 10 s0 [00:19]	LINK C. (GBR)
33	CARNA Giulia (ITA)	10 s0 / 00 s0 [01:37]	CARNA G. (ITA)
34	SHARMA Akshita (IND)	02 s0 / 00 s1 [02:43]	CARNA G. (ITA)
35	LIN Yu-Han (TPE)	02 s0 / 00 s1 [02:43]	CARNA G. (ITA)

REPECHAGE

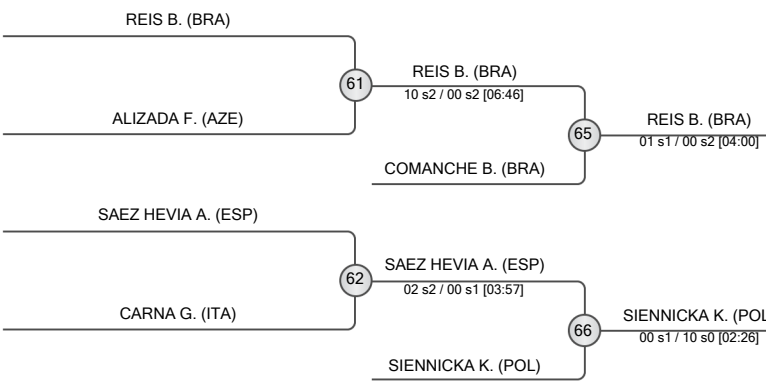

FINAL RESULTS	
1.	HONDA Riko (JPN)
2.	TAO Yuying (CHN)
3.	REIS Bianca (BRA)
3.	SIENNICKA Karolina (POL)
5.	COMANCHE Beatriz (BRA)
5.	SAEZ HEVIA Adriana (ESP)
7.	ALIZADA Fidan (AZE)
7.	CARNA Giulia (ITA)





Dushanbe World Championships Juniors Individuals 2024

Tajikistan, Dushanbe, 2-5 Oct 2024

-63 kg

Women (33)

POOL A

	AUCHECORNE Melkia	FRA	1	AUCHECORNE M. (FRA)
	BADURA Daniela	POL	2	BADURA D. (POL)
	MARKULIN Nika	CRO	3	MARKULIN N. (CRO)
	NAZAROVA Jonona	TKM	4	NAZAROVA J. (TKM)
	YANG Jimin	KOR	5	YANG J. (KOR)
	NARYMANOVA Nasiba	TKM	6	NARYMANOVA N. (TKM)
	DUIHONBEKOVA Myrzaïym	KGZ	7	DUIHONBEKOVA M. (KGZ)
	ORYMBEK Korkem	KAZ	8	ORYMBEK K. (KAZ)

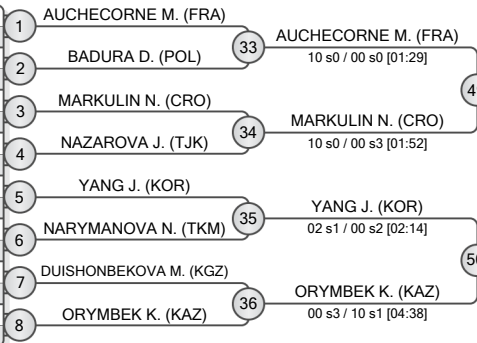

POOL B

	CORBO Sara	ITA	9	CORBO S. (ITA)
	CARROUTH Karlee	USA	10	CARROUTH K. (USA)
	SCHLOEGL Franziska	AUT	11	SCHLOEGL F. (AUT)
	BASTOS Eduarda	BRA	12	BASTOS E. (BRA)
	BAUER Sara-Joy	GER	13	BAUER S. (GER)
	KUCHAR Varvara	LTU	14	KUCHAR V. (LTU)
	SKALSKA Anna	CZE	15	SKALSKA A. (CZE)
	WEKESA Christine Naliaka	KEN	16	WEKESA C. (KEN)

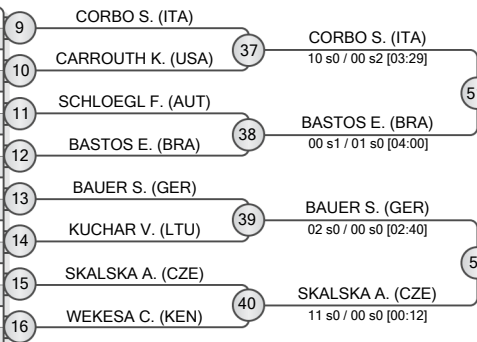

POOL C

	JASPE Emily Daniela	USA	17	JASPE E. (USA)
	TOKAS Himanshi	IND	18	TOKAS H. (IND)
	CRUZ Maria	MEX	19	CRUZ M. (MEX)
	NOACK Nele	GER	20	NOACK N. (GER)
	KOCHKONBAEVA Adina	KGZ	21	KOCHKONBAEVA A. (KGZ)
	NURULLOEVA Marjona	UZB	22	NURULLOEVA M. (UZB)
	DOLIAHVILI Nona	GEO	23	RUSSO S. (ITA)
	RUSSO Savita	ITA	23	RUSSO S. (ITA)
	CHEN Kangping	CHN	24	CHEN K. (CHN)

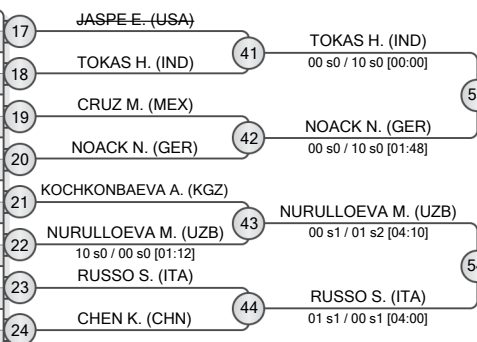

POOL D

	GEILEN Joni	NED	25	GEILEN J. (NED)
	DARKHANBATBAYAR Yesui	MGL	26	DARKHANBATBAYAR Y. (MGL)
	DZAGOEVA Dzerassa	IJF	27	DZAGOEVA D. (IJF)
	MORICHIKA So	JPN	28	MORICHIKA S. (JPN)
	CHOCO Ingrid	COL	29	CHOCO I. (COL)
	TRETNJAK Lisa	AUT	30	TRETNJAK L. (AUT)
	SIMIC Nina	CRO	31	SIMIC N. (CRO)
	ORUC Sinem	TUR	32	ORUC S. (TUR)

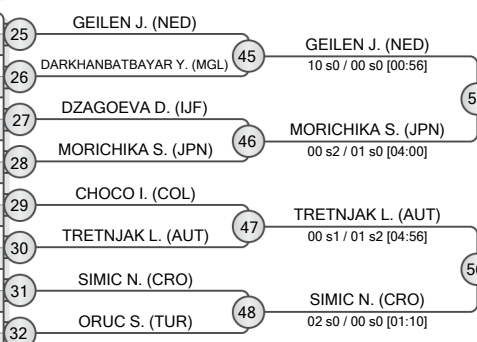

REPECHAGE



FINAL RESULTS	
1.	AUCHECORNE Melkia FRA
2.	RUSSO Savita ITA
3.	MORICHIKA So JPN
3.	SKALSKA Anna CZE
5.	CORBO Sara ITA
5.	TOKAS Himanshi IND
7.	YANG Jimin KOR
7.	TRETNJAK Lisa AUT





Dushanbe World Championships Juniors Individuals 2024

Tajikistan, Dushanbe, 2-5 Oct 2024

-70 kg

Women (39)

POOL A

	CARDOSO Kaillany	BRA	1	CARDOSO K. (BRA)
	CVJETKO Jana	CRO	2	CVJETKO J. (CRO)
	RUSLANOVA Oguljan	TKM	3	MOLDOKULOVA A. (KGZ)
	MOLDOKULOVA Alina	KGZ	3	MOLDOKULOVA A. (KGZ)
	TELBAYEVA Diana	KAZ	4	TELBAYEVA D. (KAZ)
	KOWALEWSKA Aleksandra	POL	5	KOWALEWSKA A. (POL)
	MAEDA Rin	JPN	6	MAEDA R. (JPN)
	KAYA Sumeyye	TUR	6	MAEDA R. (JPN)
	KOREN Nika	SLO	7	KOREN N. (SLO)
	PAPAGIANNAKI Alexandra	GRE	8	PAPAGIANNAKI A. (GRE)

POOL B

	DENGG Elena	AUT	9	DENGG E. (AUT)
	DEVALL Holly	GBR	10	DEVALL H. (GBR)
	AZAMOVA Firuza	IJF	11	AZAMOVA F. (IJF)
	NGANGBAM Dipapati	IND	11	AZAMOVA F. (IJF)
	WILLIAMS Chloe	USA	12	WILLIAMS C. (USA)
	KODIROVA Barchinoy	UZB	13	KODIROVA B. (UZB)
	GRUENEWALD Tanja	GER	14	FIZELOVA E. (SVK)
	FIZELOVA Ema	SVK	14	FIZELOVA E. (SVK)
	YUAN Huiting	CHN	15	YUAN H. (CHN)
	DARBES-TAKAM Teophila	FRA	16	YUAN H. (CHN)

POOL C

	FOHOOU April Lynn	SUI	17	FOHOOU A. (SUI)
	CHAYEB Aqulina	LBN	18	CHAYEB A. (LBN)
	ANDRIC Aleksandra	SRB	19	ANDRIC A. (SRB)
	DEPRI Ilona	FRA	19	ANDRIC A. (SRB)
	RAZZOKBERDIEVA Khurshida	UZB	20	RAZZOKBERDIEVA K. (UZB)
	GRAUER Tayla	GER	21	GRAUER T. (GER)
	BATSUURI Nyam-Erdene	MGL	22	BATSUURI N. (MGL)
	MARCZAK Julia	POL	23	MARCZAK J. (POL)
	ONGOCHE Eunice	KEN	23	MARCZAK J. (POL)
	GULENAY Tuana	TUR	24	GULENAY T. (TUR)

POOL D

	RASOANAIVO RAZAFY Aina Laura	MAD	25	RASOANAIVO RAZAFY A. (MAD)
	OGNIVOVA Eva	IJF	26	OGNIVOVA E. (IJF)
	NAVICKAITE Marta	LTU	27	NAVICKAITE M. (LTU)
	ASKHAT Azhar	KAZ	28	ASKHAT A. (KAZ)
	SCHUSTER Kaja	SLO	29	SCHUSTER K. (SLO)
	VIDENEIEVA Alisa	UKR	30	VIDENEIEVA A. (UKR)
	ESSATOURI Nassma	MAR	31	ESSATOURI N. (MAR)
	PARK Hajeong	KOR	31	ESSATOURI N. (MAR)
	NGUYEN Nancy	USA	32	NGUYEN N. (USA)

REPECHAGE

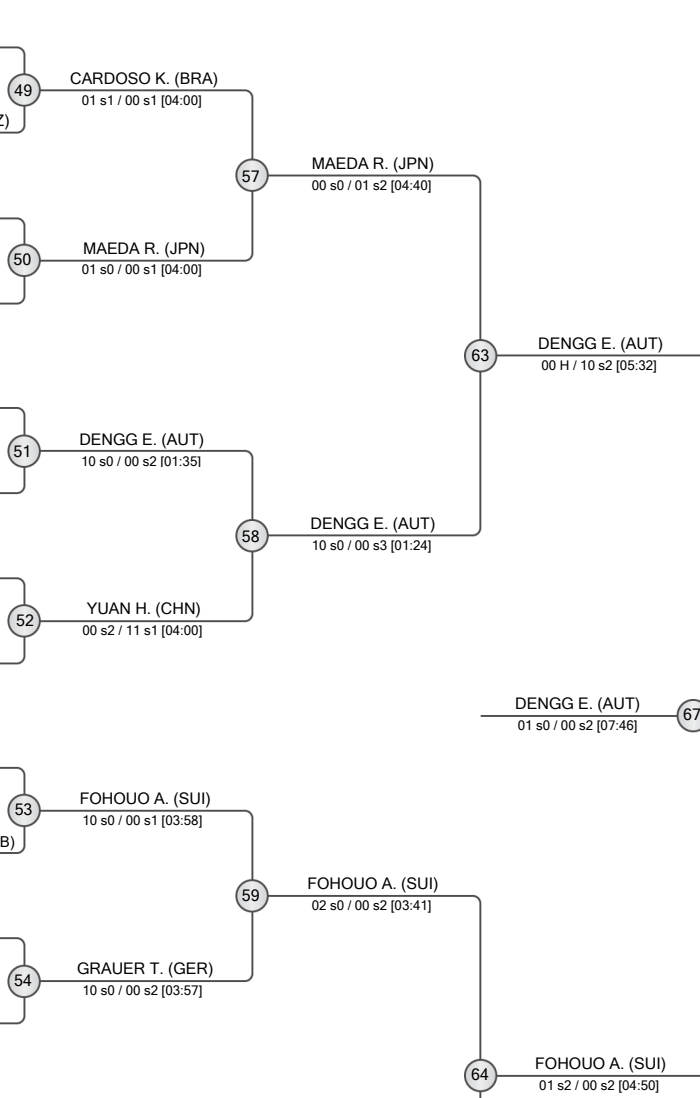
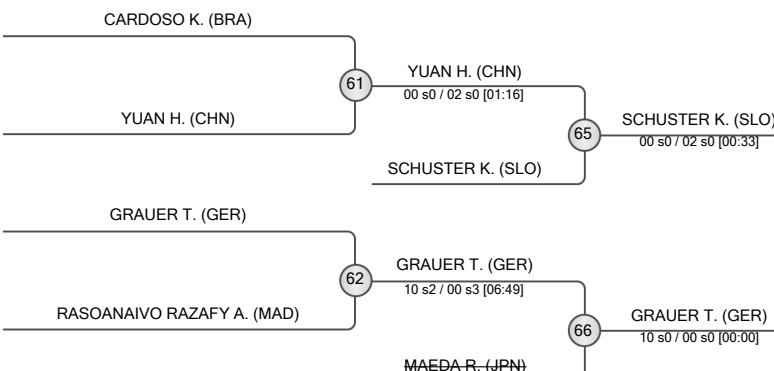

FINAL RESULTS		
1.	DENGG Elena	AUT
2.	FOHOOU April Lynn	SUI
3.	SCHUSTER Kaja	SLO
3.	GRAUER Tayla	GER
5.	YUAN Huiting	CHN
5.	MAEDA Rin	JPN
7.	CARDOSO Kaillany	BRA
7.	RASOANAIVO RAZAFY Aina Laura	MAD





Dushanbe World Championships Juniors Individuals 2024

Tajikistan, Dushanbe, 2-5 Oct 2024

-78 kg

Women (32)

POOL A

	YULDOSHOVA Shirinjon	UZB
	KOSNAROVA Marie	CZE
	MURADOVA Yyldyz	TKM
	RYLKEVICH Slaviana	IJF
	CAMILO Dandara	BRA
	UNIYAL Shruti	IND
	PERKOVIC Lorena	CRO
	CONCEICAO Fabia	POR

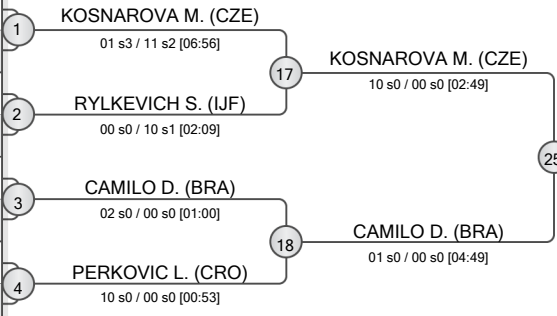

POOL B

	OLAYA Brenda	COL
	MORENO CAMPO June	ESP
	OTAWA Kokoro	JPN
	DUAN Jinye	CHN
	MAZZARINO Lila	FRA
	LYTVYVENKO Yelyzaveta	UKR
	PARK Sunyoung	KOR
	FURDAZHIEVA Akmarzhan	KGZ

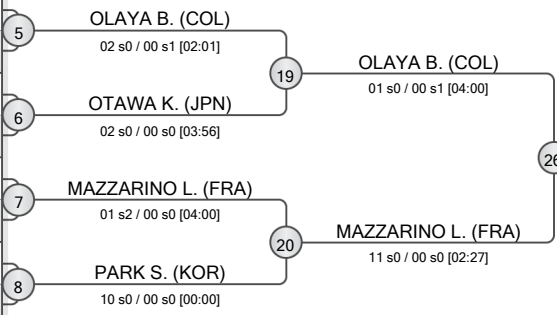

POOL C

	BUDDENKOTTE Eva Ronja	GER
	AGAC Gulsum	TUR
	LIU Tong	CHN
	OTGONBAYAR Khuslen	MGL
	KRAPU Emma	FIN
	NARANG Ishroop	IND
	SOLOVEI Valeriia	IJF
	SAGI Nikolett	HUN

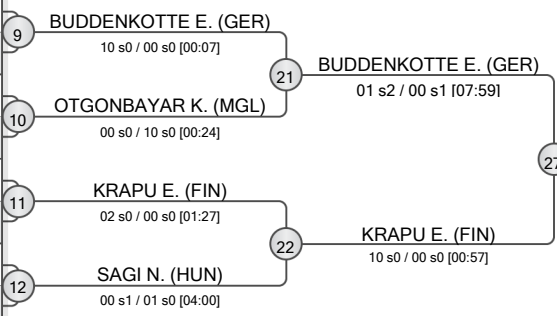

POOL D

	NIEMEYER Mathilda Sophie	GER
	DZHUMALIEVA Aiganysh	KGZ
	HANSTED E. Maria	NED
	KAZAKOVA Anna	UKR
	STJEPANOVIC Jovana	SRB
	IUDINA Polina	IJF
	KANELLOPOULOU Melina	GRE
	WANG Chieh-Hsi	TPE

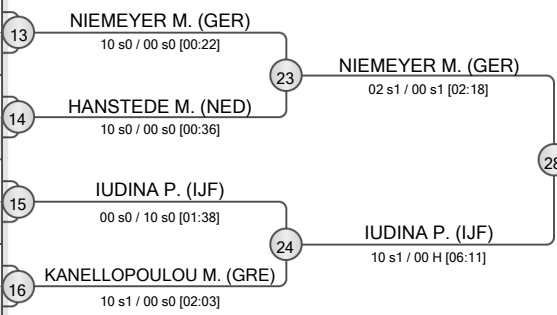

REPECHAGE

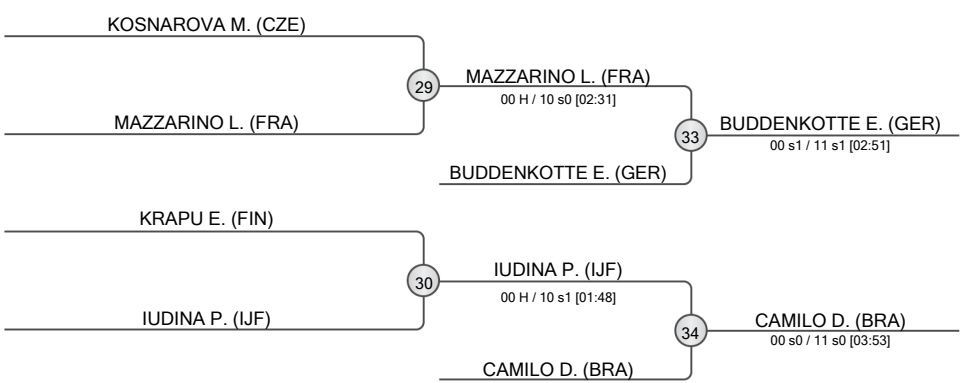

FINAL RESULTS	
1.	OLAYA Brenda COL
2.	NIEMEYER Mathilda Sophie GER
3.	BUDDENKOTTE Eva Ronja GER
3.	CAMILO Dandara BRA
5.	MAZZARINO Lila FRA
5.	IUDINA Polina IJF
7.	KOSNAROVA Marie CZE
7.	KRAPU Emma FIN





Dushanbe World Championships Juniors Individuals 2024

Tajikistan, Dushanbe, 2-5 Oct 2024

+78 kg

Women (20)

POOL A

	CANCAN Celia	FRA
	LEE Hyebin	KOR
	BHATELEY Pavitra	IND
	STASIULYTE Rugile	LTU
	SU Pin-Tzu	TPE

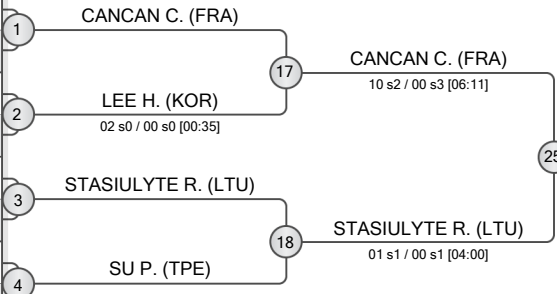

POOL B

	PIRES Enya	BRA
	NIU Xinran	CHN
	SOLIMAN Safa	EGY
	TUKHTAMISHEVA Mokhlaroyim	UZB
	YAMAGUCHI Chihiro	JPN

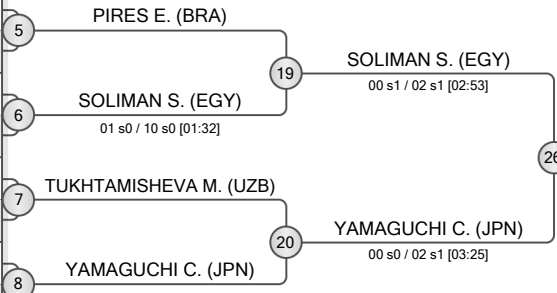

POOL C

	LEE Hyeonji	KOR
	YILMAZ Yagmur	TUR
	KISELEVA Viktoriia	TJK
	BOUVIER Gabrielle	BEL
	LIU Yu	CHN

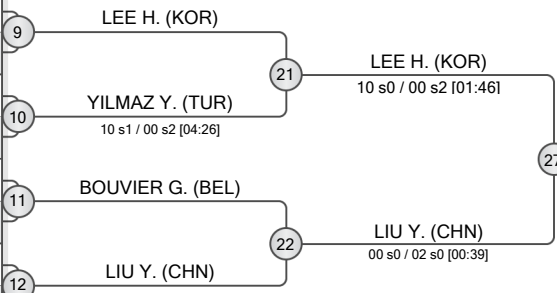

POOL D

	VRANJES Marcelina	CRO
	NIGMATOVA Umida	UZB
	MAKHATOVA Ruslana	KAZ
	OLIVEIRA Olivia	BRA
	PAPIDZE Nino	GEO

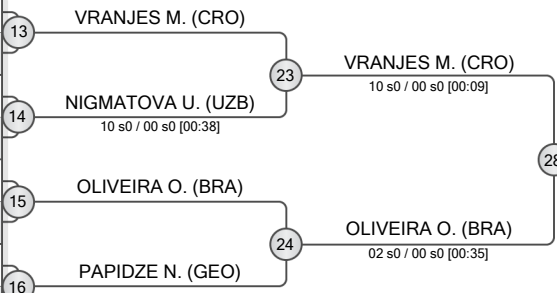

REPECHAGE

STASIULYTE R. (LTU)	YAMAGUCHI C. (JPN)
YAMAGUCHI C. (JPN)	OLIVEIRA O. (BRA)
LIU Y. (CHN)	LIU Y. (CHN)
VRANJES M. (CRO)	SOLIMAN S. (EGY)

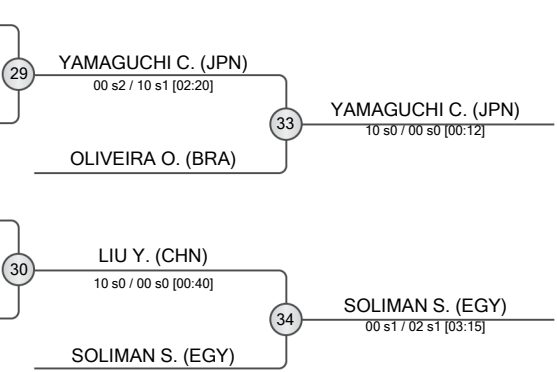

FINAL RESULTS	
1. LEE Hyeonji	KOR
2. CANCAN Celia	FRA
3. YAMAGUCHI Chihiro	JPN
3. SOLIMAN Safa	EGY
5. OLIVEIRA Olivia	BRA
5. LIU Yu	CHN
7. STASIULYTE Rugile	LTU
7. VRANJES Marcelina	CRO

