



# Event Report

Antalya Grand Slam 2024, 29-31 Mar 2024

# Event Report

## 628 competitors from 93 nations

355 Men

273 Women

56.53%

43.47%

-60 kg	-66 kg	-73 kg	-81 kg	-90 kg	-100 kg	+100 kg	Men
38	52	61	61	55	48	40	355

-48 kg	-52 kg	-57 kg	-63 kg	-70 kg	-78 kg	+78 kg	Women
42	38	44	43	41	31	34	273

Continent	AJU	JUA	EJU	OJU	PJC	Total
Nations	12	20	38	3	20	93
Competitors	25	155	356	3	89	628

Schedule			
Date	29 Mar	30 Mar	31 Mar
Start	09:30	09:30	10:00
Finals	17:00	17:00	17:00



# Antalya Grand Slam 2024

Türkiye, Antalya, 29-31 Mar 2024

Men  
**Final results**

-60 kg		
1	BLIEV Ayub	AIN
2	MKHEIDZE Luka	FRA
3	YILDIZ Salih	TUR
3	JARING Emiel	NED
5	TSJAKADOEVA Tornike	NED
5	BYAMBAJAV Tsogt-Ochir	MGL
7	ENKHTAIVAN Ariunbold	MGL
7	BARATOV Dilshodbek	UZB

-66 kg		
1	ABE Hifumi	JPN
2	EMOMALI Nurali	TJK
3	DZHEBOV Obid	TJK
3	KHYAR Walide	FRA
5	DEMIREL Muhammed	TUR
5	GARCIA TORNE David	ESP
7	BAYANMUNKH Narmandakh	UAE
7	AIBEK UULU Kubanychbek	KGZ

-73 kg		
1	OSMANOV Adil	MDA
2	MAMMADALIYEV Rashid	AZE
3	DEMIREL Umalt	TUR
3	AKHADOV Shakhram	UZB
5	PARLATI Manuel	ITA
5	SHEROV Abubakr	TJK
7	CILOGLU Bilal	TUR
7	TERADA Masayuki	THA

-81 kg		
1	NAGASE Takanori	JPN
2	GAUTHIER DRAPEAU Francois	CAN
3	SCHIMIDT Guilherme	BRA
3	FERNANDO Joao	POR
5	ESPOSITO Antonio	ITA
5	KARAPETYAN David	AIN
7	ALBAYRAK Vedat	TUR
7	STERPU Victor	MDA

-90 kg		
1	MURAO Sanshiro	JPN
2	TALIBOV Vugar	AZE
3	SILVA MORALES Ivan Felipe	CUB
3	ZGANK Mihael	TUR
5	BOBONOV Davlat	UZB
5	SAFRANY Peter	HUN
7	NGAYAP HAMBOU Maxime-Gael	FRA
7	MACEDO Rafael	BRA

-100 kg		
1	FONSECA Jorge	POR
2	ELNAHAS Shady	CAN
3	BATKHUYAG Gonchigsuren	MGL
3	WOLF Aaron	JPN
5	GONCALVES Leonardo	BRA
5	ADAMIAN Arman	AIN
7	KORREL Michael	NED
7	KUKOLJ Aleksandar	SRB

+100 kg		
1	RINER Teddy	FRA
2	SAITO Tatsuru	JPN
3	ABRAMOV Erik	GER
3	ENDOITSKIY Valeriy	AIN
5	BAKHTIYOROV Shokhrukhkhon	UZB
5	SILVA Rafael	BRA
7	FIZEL Marius	SVK
7	PUUMALAINEN Martti	FIN



# Antalya Grand Slam 2024

Türkiye, Antalya, 29-31 Mar 2024

## Women Final results

-48 kg		
1	TSUNODA Natsumi	JPN
2	ERSIN Sila	TUR
3	ABUZHAKYNOVA Abiba	KAZ
3	GANBAATAR Narantsetseg	MGL
5	GILIAZOVA Sabina	AIN
5	FERREIRA Natasha	BRA
7	AZAK Merve	TUR
7	LABORDE Maria Celia	USA

-52 kg		
1	ABE Uta	JPN
2	GILES Chelsie	GBR
3	LEIVA SANCHEZ Ayumi	ESP
3	PULJIZ Ana Viktorija	CRO
5	KADAMBOEVA Sita	UZB
5	GIUFFRIDA Odette	ITA
7	DEGUCHI Kelly	CAN
7	ZHU Yeqing	CHN

-57 kg		
1	DEGUCHI Christa	CAN
2	LIMA Jessica	BRA
3	PARDAYEVA Maysa	TKM
3	MOKDAR Faiza	FRA
5	CAI Qi	CHN
5	BALLHAUS Seija	GER
7	KIM Juhee	KOR
7	PODOLAK Arleta	POL

-63 kg		
1	KIM Jisu	KOR
2	LILUASHVILI Dali	AIN
3	TAKAICHI Miku	JPN
3	KRISTO Katarina	CRO
5	KRSSAKOVA Magdalena	AUT
5	OBERAN Iva	CRO
7	BEAUCHEMIN-PINARD Catherine	CAN
7	CORRAO Alessia	BEL

-70 kg		
1	POLLERES Michaela	AUT
2	PINA Tais	POR
3	TAIMAZOVA Madina	AIN
3	TSUNODA ROUSTANT Ai	ESP
5	POLLING Kim	NED
5	COUGHLAN Aoife	AUS
7	CARVALHO Luana	BRA
7	SCOCCIMARRO Giovanna	GER

-78 kg		
1	MALONGA Madeleine	FRA
2	BOEHM Alina	GER
3	MA Zhenzhao	CHN
3	WAGNER Anna-Maria	GER
5	REID Emma	GBR
5	STANGHERLIN Giorgia	ITA
7	SAMPAIO Patricia	POR
7	LOBNIK Metka	SLO

+78 kg		
1	TOLOFUA Julia	FRA
2	SU Xin	CHN
3	OZDEMIR Kayra	TUR
3	OZTURK Hilal	TUR
5	KIM Hayun	KOR
5	FONTAINE Lea	FRA
7	XU Shiyan	CHN
7	ZABIC Milica	SRB



# Medals

Antalya Grand Slam 2024, 29-31 Mar 2024

# Medals

Nations: 22

#	Nation		1. Place	2. Place	3. Place	4. Place	5. Place	7. Place
		JPN Japan	5	1	2			
		FRA France	3	1	2		1	1
		CAN Canada	1	2				2
		POR Portugal	1	1	1			1
		KOR Republic of Korea	1				1	1
		AUT Austria	1				1	
		MDA Republic of Moldova	1					1
		AZE Azerbaijan		2				
		TUR Türkiye		1	5		1	3
		GER Germany		1	2		1	1
		BRA Brazil		1	1		3	2
		CHN People's Republic of China		1	1		1	2
		TJK Tajikistan		1	1		1	
		GBR Great Britain		1			1	
		MGL Mongolia			2		1	1
		CRO Croatia			2		1	
		ESP Spain			2		1	
		UZB Uzbekistan			1		3	1
		NED Netherlands			1		2	1
		CUB Cuba			1			
		KAZ Kazakhstan			1			
		TKM Turkmenistan			1			
		ITA Italy					4	
		AUS Australia					1	
		HUN Hungary					1	
		SRB Serbia						2
		BEL Belgium						1
		FIN Finland						1
		KGZ Kyrgyzstan						1
		POL Poland						1
		SVK Slovakia						1
		SLO Slovenia						1
		THA Thailand						1
		UAE United Arab Emirates						1
		USA United States of America						1

Official person:



# Statistics

Antalya Grand Slam 2024, 29-31 Mar 2024

# Statistics

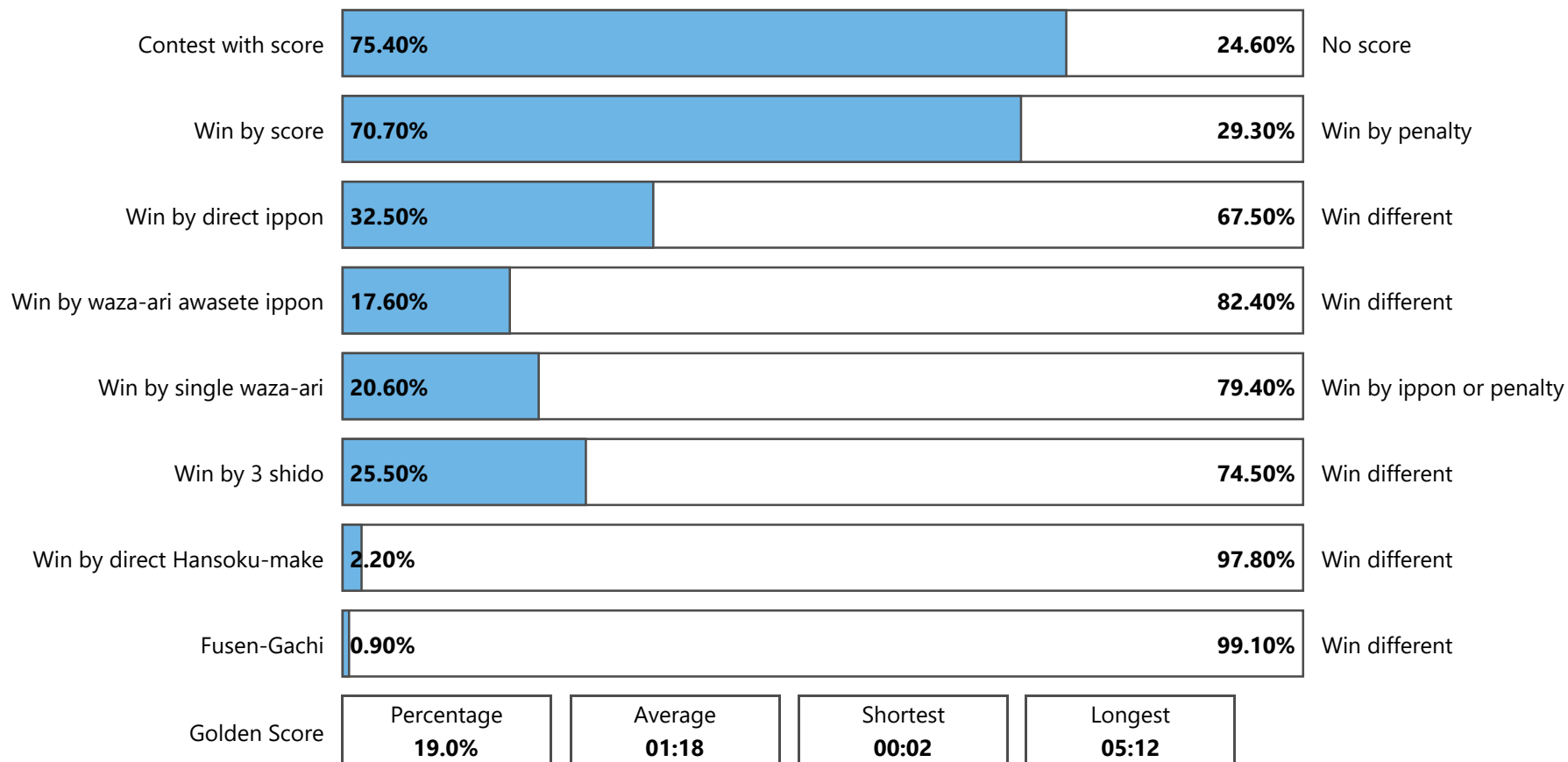



# Statistics

Antalya Grand Slam 2024, 29-31 Mar 2024

# Statistics

	-60	-66	-73	-81	-90	-100	+100	M	-48	-52	-57	-63	-70	-78	+78	W	Total
Competitors	38	52	61	61	55	48	40	<b>355</b>	42	38	44	43	41	31	34	<b>273</b>	<b>628</b>
Contests	41	55	64	64	58	51	43	<b>376</b>	45	41	47	46	44	34	37	<b>294</b>	<b>670</b>
Contests with score	31	43	54	48	39	41	33	<b>289</b>	38	30	26	36	31	27	28	<b>216</b>	<b>505</b>
Contests with score %	75.6%	78.2%	84.4%	75%	67.2%	80.4%	76.7%	<b>76.9%</b>	84.4%	73.2%	55.3%	78.3%	70.5%	79.4%	75.7%	<b>73.5%</b>	<b>75.4%</b>
Wins by Score	29	41	50	47	39	38	31	<b>275</b>	35	30	26	31	28	24	25	<b>199</b>	<b>474</b>
Wins by Score %	70.7%	74.5%	78.1%	73.4%	67.2%	74.5%	72.1%	<b>73.1%</b>	77.8%	73.2%	55.3%	67.4%	63.6%	70.6%	67.6%	<b>67.7%</b>	<b>70.7%</b>
Wins by direct Ippon	9	21	22	23	17	24	17	<b>133</b>	16	12	11	12	10	10	14	<b>85</b>	<b>218</b>
Wins by direct Ippon %	22%	38.2%	34.4%	35.9%	29.3%	47.1%	39.5%	<b>35.4%</b>	35.6%	29.3%	23.4%	26.1%	22.7%	29.4%	37.8%	<b>28.9%</b>	<b>32.5%</b>
Wins by Waza-ari Awasete Ippon	7	9	11	8	10	4	12	<b>61</b>	8	10	6	9	8	9	7	<b>57</b>	<b>118</b>
Wins by Waza-ari Awasete Ippon %	17.1%	16.4%	17.2%	12.5%	17.2%	7.8%	27.9%	<b>16.2%</b>	17.8%	24.4%	12.8%	19.6%	18.2%	26.5%	18.9%	<b>19.4%</b>	<b>17.6%</b>
Wins by single Waza-ari	13	11	17	16	12	10	2	<b>81</b>	11	8	9	10	10	5	4	<b>57</b>	<b>138</b>
Wins by single Waza-ari %	31.7%	20%	26.6%	25%	20.7%	19.6%	4.7%	<b>21.5%</b>	24.4%	19.5%	19.1%	21.7%	22.7%	14.7%	10.8%	<b>19.4%</b>	<b>20.6%</b>
Wins by 3 Shido for opponent	10	11	11	16	17	10	11	<b>86</b>	10	10	17	14	12	10	12	<b>85</b>	<b>171</b>
Wins by 3 Shido for opponent %	24.4%	20%	17.2%	25%	29.3%	19.6%	25.6%	<b>22.9%</b>	22.2%	24.4%	36.2%	30.4%	27.3%	29.4%	32.4%	<b>28.9%</b>	<b>25.5%</b>
Direct Hansoku-make	1	3	2	1			1	<b>8</b>		1	4	1	1			<b>7</b>	<b>15</b>
Wins by direct Hansoku-make %	2.4%	5.5%	3.1%	1.6%	0%	0%	2.3%	<b>2.1%</b>	0%	2.4%	8.5%	2.2%	2.3%	0%	0%	<b>2.4%</b>	<b>2.2%</b>
Fusen-gachi					2	2		<b>4</b>					2			<b>2</b>	<b>6</b>
Fusen-gachi %	0%	0%	0%	0%	3.4%	3.9%	0%	<b>1.1%</b>	0%	0%	0%	0%	4.5%	0%	0%	<b>0.7%</b>	<b>0.9%</b>
All positive Scores (Waza-ari + direct Ippon)	42	57	72	68	62	52	52	<b>405</b>	51	44	36	51	44	39	39	<b>304</b>	<b>709</b>
Average Scores per contests	1	1	1.1	1.1	1.1	1	1.2	<b>1.07</b>	1.1	1.1	0.8	1.1	1	1.1	1.1	<b>1.04</b>	<b>1.06</b>
All penalties (Shido + HSK)	106	126	123	144	143	103	100	<b>845</b>	107	88	139	111	94	64	81	<b>684</b>	<b>1529</b>
Average penalty per contest	2.6	2.3	1.9	2.3	2.5	2	2.3	<b>2.27</b>	2.4	2.1	3	2.4	2.1	1.9	2.2	<b>2.3</b>	<b>2.29</b>
Golden Score	12	14	14	11	9	11	2	<b>73</b>	11	8	13	11	8	2	1	<b>54</b>	<b>127</b>
Golden Score %	29.3%	25.5%	21.9%	17.2%	15.5%	21.6%	4.7%	<b>19.4%</b>	24.4%	19.5%	27.7%	23.9%	18.2%	5.9%	2.7%	<b>18.4%</b>	<b>19.0%</b>
Osae-komi																	
Osae-komi %	0%	0%	0%	0%	0%	0%	0%	<b>0%</b>	0%	0%	0%	0%	0%	0%	0%	<b>0%</b>	<b>0%</b>
Wins by Penalty	11	14	13	17	17	10	12	<b>94</b>	10	11	21	15	13	10	12	<b>92</b>	<b>186</b>



# Nations Overview

Antalya Grand Slam 2024, 29-31 Mar 2024

# Nations

Overview

			-60	-66	-73	-81	-90	-100	+100	M	-48	-52	-57	-63	-70	-78	+78	W	Total	D	
1.		AIN	Individual Neutral Athletes	3	3	0	2	3	2	1	14	2	2	2	3	2	3	1	15	29	10
2.		ALG	Algeria	0	0	0	0	0	0	1	1	0	0	0	1	0	0	0	1	2	3
3.		ARG	Argentina	1	0	1	1	1	0	0	4	1	1	1	0	0	0	0	3	7	2
4.		AUS	Australia	0	0	0	0	0	0	0	0	0	0	0	0	1	0	0	1	1	1
5.		AUT	Austria	1	1	2	1	1	1	1	8	2	0	2	2	1	0	1	8	16	5
6.		AZE	Azerbaijan	1	2	2	1	1	0	2	9	0	0	0	0	0	0	0	0	9	8
7.		BAH	Bahamas	0	0	1	0	0	0	0	1	0	0	0	0	0	0	0	0	1	0
8.		BEL	Belgium	1	0	0	1	2	1	0	5	1	1	0	1	0	0	0	3	8	4
9.		BIH	Bosnia and Herzegovina	0	0	0	0	1	0	0	1	0	0	1	0	1	0	1	3	4	1
10.		BRA	Brazil	0	0	2	2	2	2	1	9	2	2	2	2	2	0	0	10	19	10
11.		BRN	Bahrain	0	0	2	0	1	1	1	5	0	0	0	0	0	0	0	0	5	1
12.		BUL	Bulgaria	0	2	1	1	0	2	0	6	0	1	0	1	0	0	0	2	8	4
13.		CAN	Canada	0	1	1	1	1	2	0	6	0	1	1	1	0	0	1	4	10	3
14.		CHI	Chile	0	0	0	1	0	0	0	1	1	0	0	0	0	0	0	1	2	1
15.		CHN	People's Republic of China	0	0	0	0	0	0	0	0	2	1	1	1	1	1	2	9	9	6
16.		COD	Democratic Republic of the Congo	0	0	0	1	0	0	1	2	0	0	0	0	0	0	0	0	2	1
17.		COL	Colombia	1	1	0	0	0	1	0	3	1	0	0	0	0	0	0	1	4	1
18.		CRC	Costa Rica	1	0	1	0	0	0	0	2	0	0	0	0	0	0	0	0	2	0
19.		CRO	Croatia	0	0	0	0	0	1	0	1	0	1	1	2	0	2	2	8	9	6
20.		CUB	Cuba	1	1	1	0	1	0	1	5	0	1	0	1	0	1	1	4	9	5
21.		CYP	Cyprus	0	1	1	0	0	0	1	3	0	1	0	0	0	1	0	2	5	1
22.		CZE	Czechia	0	0	0	0	1	0	0	1	0	0	0	0	0	0	0	0	1	1
23.		DEN	Denmark	0	0	0	0	0	1	0	1	0	0	0	0	2	0	0	2	3	1
24.		DOM	Dominican Republic	0	0	1	1	1	0	0	3	0	0	0	0	0	0	1	1	4	1
25.		EGY	Egypt	1	1	0	2	0	0	0	4	0	0	0	0	0	0	0	0	4	2
26.		ESP	Spain	0	1	2	2	2	0	0	7	1	2	2	2	1	0	0	8	15	9
27.		EST	Estonia	0	2	0	0	1	0	1	4	0	0	0	0	0	0	0	0	4	1
28.		FIJ	Fiji	0	0	0	0	0	0	0	0	0	0	0	0	1	0	0	1	1	0
29.		FIN	Finland	0	1	1	1	0	0	1	4	0	0	2	0	0	0	0	2	6	1
30.		FRA	France	2	1	1	1	1	0	1	7	2	0	1	1	0	1	2	7	14	16
31.		GAB	Gabon	0	0	0	0	0	0	0	0	1	0	0	0	0	0	0	1	1	1
32.		GAM	Gambia	0	0	1	0	0	0	0	1	0	0	0	0	0	0	0	0	1	0
33.		GBR	Great Britain	0	2	1	1	1	1	0	6	0	1	2	1	2	2	0	8	14	7
34.		GBS	Guinea-Bissau	0	0	0	0	0	0	1	1	0	0	0	0	0	0	0	0	1	0
35.		GEO	Georgia	0	1	0	2	2	1	1	7	0	0	0	0	1	0	1	2	9	6
36.		GER	Germany	0	1	2	2	2	2	2	11	1	1	2	2	2	2	2	12	23	7
37.		GRE	Greece	1	0	0	0	1	0	0	2	0	0	0	0	0	0	0	0	2	1
38.		GUA	Guatemala	1	0	0	0	0	0	0	1	1	0	0	0	0	0	0	1	2	1
39.		GUI	Guinea	0	0	0	0	0	0	0	0	0	0	1	0	0	1	0	2	2	1
40.		HAI	Haiti	0	0	1	0	0	0	0	1	0	0	0	0	0	0	0	0	1	0
41.		HKG	Hong Kong, China	0	0	1	1	0	0	0	2	2	0	1	0	0	0	0	3	5	2
42.		HUN	Hungary	0	0	0	1	1	1	0	3	0	2	0	0	1	0	0	3	6	8
43.		IND	India	1	0	0	0	0	1	0	2	0	1	1	1	0	0	0	3	5	0
44.		IRL	Ireland	0	0	1	0	0	0	0	1	0	0	0	0	1	0	0	1	2	1
45.		ITA	Italy	2	1	2	1	0	1	0	7	1	1	2	2	2	1	1	10	17	13
46.		JAM	Jamaica	1	0	0	1	0	0	0	2	0	0	0	0	1	0	0	1	3	1



# Nations Overview

Antalya Grand Slam 2024, 29-31 Mar 2024

# Nations

Overview

			-60	-66	-73	-81	-90	-100	+100	M	-48	-52	-57	-63	-70	-78	+78	W	Total	D	
47.		JPN	Japan	0	1	0	1	1	1	1	5	1	1	0	1	0	0	3	8	25	
48.		KAZ	Kazakhstan	1	1	1	1	1	2	2	9	2	1	1	2	1	2	2	11	20	17
49.		KGZ	Kyrgyzstan	0	2	1	1	1	0	0	5	0	0	0	0	0	0	0	5	1	
50.		KOR	Republic of Korea	0	1	2	0	2	2	0	7	0	2	1	1	1	0	2	7	14	7
51.		KSA	Saudi Arabia	0	0	2	1	0	0	1	4	0	0	0	0	0	1	1	5	4	
52.		LAT	Latvia	0	1	0	0	0	1	0	2	0	0	1	0	0	1	0	2	4	1
53.		LTU	Lithuania	0	0	1	0	0	0	0	1	0	0	0	0	1	1	0	2	3	2
54.		MAD	Madagascar	0	0	0	0	0	0	0	0	0	0	0	0	1	0	0	1	1	0
55.		MAR	Morocco	0	1	0	1	0	0	1	3	0	0	0	0	1	1	0	2	5	1
56.		MDA	Republic of Moldova	0	1	2	2	0	0	0	5	0	0	0	0	0	0	1	1	6	2
57.		MEX	Mexico	1	0	1	0	0	0	0	2	1	1	0	0	0	0	0	2	4	4
58.		MGL	Mongolia	2	0	1	2	1	1	2	9	2	0	2	1	1	2	2	10	19	3
59.		MLT	Malta	0	0	0	0	0	1	0	1	1	0	0	0	0	0	0	1	2	1
60.		MNE	Montenegro	0	1	1	0	0	0	1	3	0	0	0	0	0	0	0	0	3	1
61.		MON	Monaco	0	0	1	0	0	0	1	2	0	0	0	0	0	0	0	0	2	1
62.		MRI	Mauritius	0	0	0	0	0	0	0	0	1	0	0	0	0	0	0	1	1	0
63.		NED	Netherlands	2	0	1	1	1	2	2	9	1	0	0	0	2	1	0	4	13	5
64.		NZL	New Zealand	0	0	0	1	0	0	0	1	0	0	0	0	0	0	0	0	1	1
65.		PAN	Panama	0	0	0	0	0	0	0	0	0	0	1	0	0	0	0	1	1	1
66.		PAR	Paraguay	1	0	0	0	1	0	0	2	1	0	0	0	0	0	0	1	3	1
67.		PER	Peru	0	1	0	0	1	0	0	2	0	0	0	0	0	1	0	1	3	1
68.		PHI	Philippines	0	1	1	0	0	0	0	2	0	0	0	1	0	0	0	1	3	1
69.		POL	Poland	0	0	2	1	0	0	2	5	0	1	2	1	1	1	1	7	12	5
70.		POR	Portugal	1	1	2	2	0	1	0	7	1	1	0	1	2	1	0	6	13	5
71.		QAT	Qatar	0	0	0	2	0	0	0	2	0	0	0	0	0	0	0	0	2	1
72.		ROU	Romania	0	0	1	1	2	1	0	5	0	0	0	1	0	0	0	1	6	4
73.		RSA	South Africa	0	0	0	0	0	0	0	0	1	0	1	0	0	0	0	2	2	0
74.		SEN	Senegal	0	0	0	0	2	0	1	3	0	0	0	0	0	0	0	0	3	1
75.		SLO	Slovenia	0	0	0	1	0	0	2	3	1	0	0	0	1	1	0	3	6	3
76.		SRB	Serbia	0	1	1	1	1	2	1	7	0	0	0	2	0	1	1	4	11	7
77.		SRI	Sri Lanka	0	0	0	1	0	0	0	1	0	0	0	0	0	0	0	0	1	0
78.		SUI	Switzerland	0	0	1	1	0	1	0	3	0	2	0	0	0	0	0	2	5	2
79.		SVK	Slovakia	0	1	0	0	2	1	1	5	0	0	0	0	0	0	0	0	5	1
80.		SWE	Sweden	0	0	0	0	1	0	0	1	0	0	0	0	1	0	0	1	2	2
81.		THA	Thailand	0	0	1	0	0	0	0	1	0	0	0	0	0	0	0	0	1	0
82.		TJK	Tajikistan	2	2	1	1	2	2	0	10	0	2	0	0	0	0	0	2	12	7
83.		TKM	Turkmenistan	1	2	0	0	1	1	0	5	1	0	1	1	0	0	0	3	8	3
84.		TPE	Chinese Taipei	1	0	0	0	0	0	0	1	2	1	1	0	1	1	0	6	7	13
85.		TTO	Trinidad And Tobago	0	0	0	0	0	0	0	0	0	0	0	0	0	0	1	1	1	0
86.		TUR	Türkiye	3	4	4	4	4	3	3	25	4	2	4	4	1	1	4	20	45	9
87.		UAE	United Arab Emirates	0	1	1	1	1	0	0	4	0	1	0	0	0	0	0	1	5	4
88.		UKR	Ukraine	1	1	1	2	2	2	1	10	0	0	1	2	0	0	1	4	14	4
89.		URU	Uruguay	0	0	0	1	0	0	0	1	0	0	0	0	0	0	0	0	1	1
90.		USA	United States of America	0	2	0	1	0	1	0	4	1	1	1	1	1	0	0	5	9	1
91.		UZB	Uzbekistan	2	2	2	2	1	2	1	12	0	2	1	0	2	1	1	7	19	12
92.		VEN	Venezuela	0	1	0	0	0	0	0	1	0	0	0	0	1	0	1	2	3	1





# Nations Overview

Antalya Grand Slam 2024, 29-31 Mar 2024

# Nations

Overview

			-60	-66	-73	-81	-90	-100	+100	M	-48	-52	-57	-63	-70	-78	+78	W	Total	D
93.		VIE	Vietnam		1	0	0	0	0	0	0	0	1	0	0	0	0	1	2	1
			38	52	61	61	55	48	40	355	42	38	44	43	41	31	34	273	628	321



# Antalya Grand Slam 2024

Türkiye, Antalya, 29-31 Mar 2024

## -60 kg

Men (38)

POOL A

1	YANG Yung Wei (TPE)	YANG Y. (TPE)
2	FREGGIARO Ignacio (ARG)	CHU D. (VIE)
3	CHU Duc Dat (VIE)	BLIEV A. (AIN)
4	BLIEV Ayub (AIN)	CABRAL M. (PAR)
5	CABRAL Mateo (PAR)	YILDIZ S. (TUR)
6	YILDIZ Salih (TUR)	YUSIFOV A. (AZE)
7	YUSIFOV Ahmad (AZE)	CARLINO A. (ITA)
8	RUZIEV Doston (UZB)	CARLINO A. (ITA)
	CARLINO Andrea (ITA)	RAMOS J. (GUA)
	RAMOS Jose (GUA)	

POOL B

9	REVOL Cedric (FRA)	REVOL C. (FRA)
10	SUFIEV Mehrzod (TJK)	SUFIEV M. (TJK)
11	KARAHAN Emirhan (TUR)	JARING E. (NED)
12	JARING Emiel (NED)	CHARON J. (CUB)
13	CHARON Jonathan (CUB)	ENKHTAIVAN A. (MGL)
14	ENKHTAIVAN Ariunbold (MGL)	JUAREZ A. (MEX)
15	JUAREZ Arath (MEX)	ROJAS J. (COL)
16	ROJAS Johan (COL)	SANCHO S. (CRC)
	SANCHO Sebastian (CRC)	

POOL C

17	MKHEIDZE Luka (FRA)	MKHEIDZE L. (FRA)
18	SAMY Youssry (EGY)	SAMY Y. (EGY)
19	LEUTGEB Daniel (AUT)	ESENOGA Y. (TUR)
20	ESENOGA Yunus Emre (TUR)	OMIROV A. (TKM)
21	OMIROV Aybek (TKM)	SERIKBAYEV N. (KAZ)
22	SERIKBAYEV Nurkanat (KAZ)	BYAMBAJAV T. (MGL)
23	GULOV Haqdod (TJK)	BYAMBAJAV T. (MGL)
24	BYAMBAJAV Tsogt-Ochir (MGL)	LOPES R. (POR)
	LOPES Rodrigo Costa (POR)	KOLASAU A. (AIN)
	KOLASAU Artsiom (AIN)	

POOL D

25	BARATOV Dilshodbek (UZB)	BARATOV D. (UZB)
26	PINTSIS Christos (GRE)	PINTSIS C. (GRE)
27	PANTANO Angelo (ITA)	PANTANO A. (ITA)
28	YADAV Vijay Kumar (IND)	YADAV V. (IND)
29	VERSTRAETEN Jorre (BEL)	VERSTRAETEN J. (BEL)
30	TSJAKADOEA T. (NED)	TSJAKADOEA T. (NED)
31	TSJAKADOEA Tornike (NED)	SAAEV I. (AIN)
32	SAAEV Iznaur (AIN)	MCKENZIE A. (JAM)
	MCKENZIE Ashley (JAM)	

REPECHAGE

61	YILDIZ S. (TUR)	YILDIZ S. (TUR)
	ENKHTAIVAN A. (MGL)	YILDIZ S. (TUR)
		TSJAKADOEA T. (NED)
62	BYAMBAJAV T. (MGL)	BYAMBAJAV T. (MGL)
	BARATOV D. (UZB)	JARING E. (NED)
		JARING E. (NED)

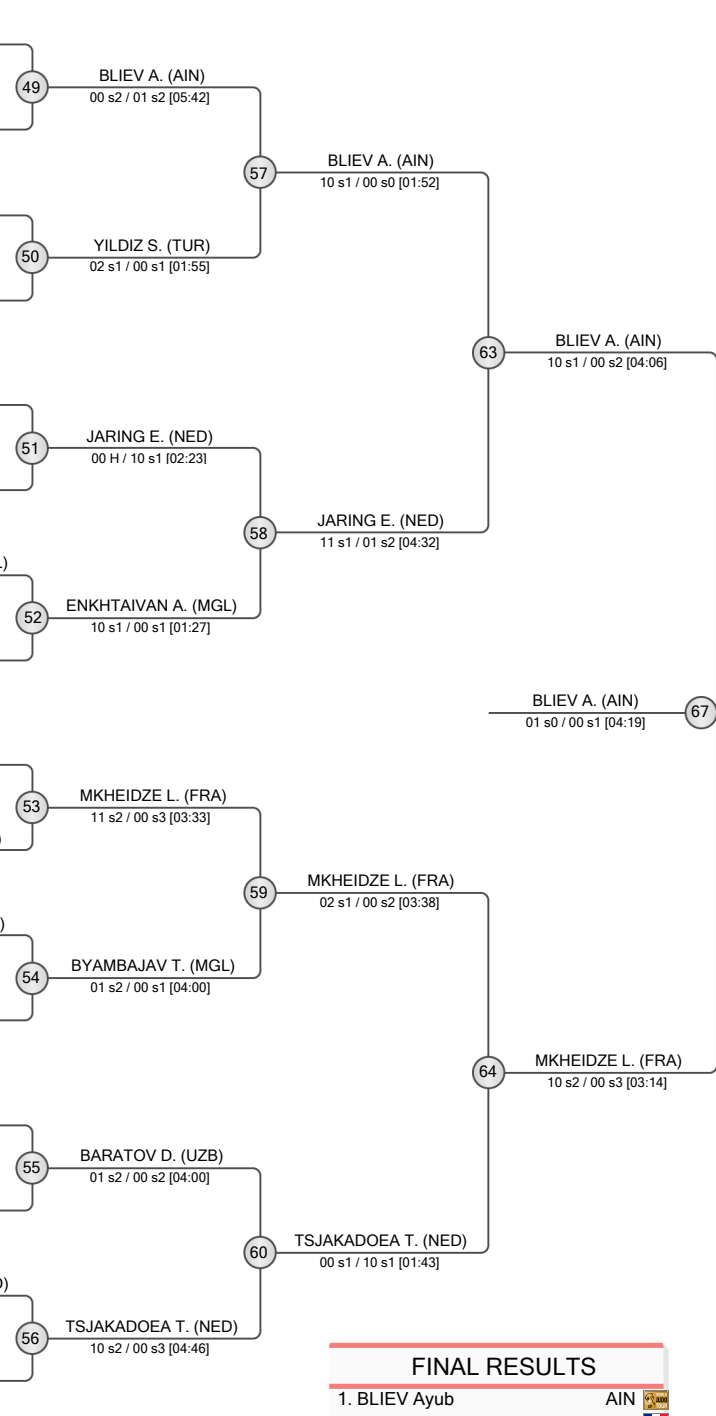

FINAL RESULTS		
1.	BLIEV Ayub	AIN
2.	MKHEIDZE Luka	FRA
3.	YILDIZ Salih	TUR
3.	JARING Emiel	NED
5.	TSJAKADOEA Tornike	NED
5.	BYAMBAJAV Tsogt-Ochir	MGL
7.	ENKHTAIVAN Ariunbold	MGL
7.	BARATOV Dilshodbek	UZB





# Antalya Grand Slam 2024

Türkiye, Antalya, 29-31 Mar 2024

# -66 kg

## Men (52)

POOL A

1	ABE Hifumi	JPN
2	BALARJISHVILI Georgios	CYP
3	HALL Samuel	GBR
4	KARSLI Mizam	TUR
5	BOUSHITA Abderrahmane	MAR
6	NURKOVIC Jusuf	MNE
7	BAYANMUNKH Narmandakh	UAE
8	CHOPANOV Murad	AIN
9	RAMIREZ Isaiah	USA
10	KYRGYZBAYEV Gusman	KAZ
11	GARCIA Willis	VEN
12	PERTELSON Oscar	EST
13	POSTIGOS Juan	PER

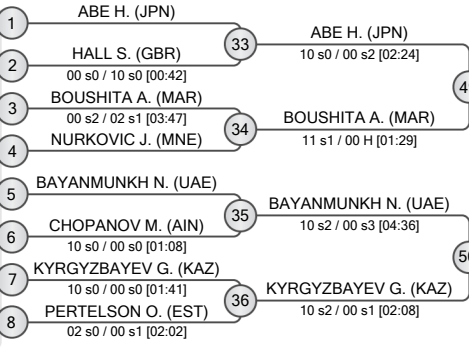

POOL B

9	KHYAR Walide	FRA
10	HERNANDEZ Juan	COL
11	ZIRAKASHVILI Tengso	GEO
12	POLIAK Matej	SVK
13	RAHIMOV Serdar	TKM
14	BUNCIC Strahinja	SRB
15	NURILLAEV Sardor	UZB
16	YOTOV Boyan	BUL
17	POLANCO Orlando	CUB
18	DZHEBOV Obid	TJK
19	AKKUS Mihrac	TUR
20	YELKIYEV Rashad	AZE
21	SALAMAT UULU Baibol	KGZ

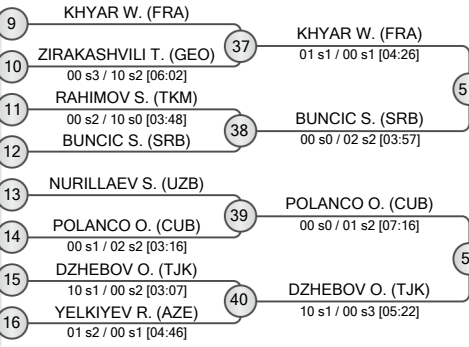

POOL C

17	GARCIA TORNE David	ESP
18	BERLINER Ari	USA
19	LIPARD Viljar	EST
20	IZVOREANU Radu	MDA
21	GAGO Miguel	POR
22	YOUNG Charlie	GBR
23	AN Baul	KOR
24	DEMIREL Muhammed	TUR
25	PASHAYEV Ruslan	AZE
26	SETZ Martin	GER
27	ALESKEROV Rufat	AIN
28	DE ANGELIS Anthony	LAT
29	FRASCADORE Julien	CAN

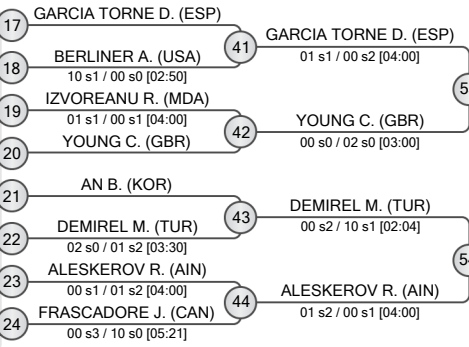

POOL D

25	TILOVOV Mukhiddin	UZB
26	SHOKA Konrad	AIN
27	SAHA Luukas	FIN
28	OZCAN Abdullah Berkin	TUR
29	AUER Marcus	AUT
30	AIBEK UULU Kubanychbek	KGZ
31	NAKANO Shugen	PHI
32	EMOMALI Nurali	TJK
33	MANZI Elios	ITA
34	HOLOBORODKO Mykyta	UKR
35	AGAMAMMEDOV Hekim	TKM
36	GERCHEV Yanislav	BUL
37	ABDELMAWGOUD Mohamed	EGY

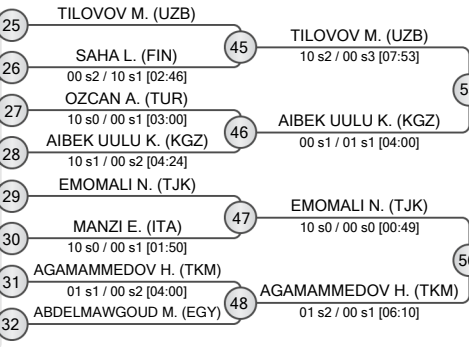

REPECHAGE

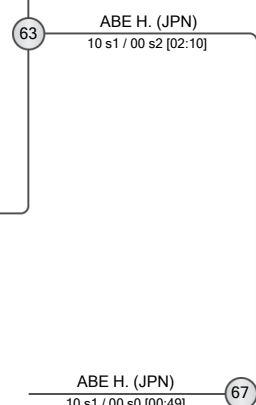

FINAL RESULTS		
1.	ABE Hifumi	JPN
2.	EMOMALI Nurali	TJK
3.	DZHEBOV Obid	TJK
3.	KHYAR Walide	FRA
5.	DEMIREL Muhammed	TUR
5.	GARCIA TORNE David	ESP
7.	BAYANMUNKH Narmandakh	UAE
7.	AIBEK UULU Kubanychbek	KGZ





# Antalya Grand Slam 2024

Türkiye, Antalya, 29-31 Mar 2024

# -73 kg

## Men (61)

POOL A

1	YULDOSHEV Murodjon (UZB)	33	CILOGLU B. (TUR)
2	CILOGLU Bilal (TUR)	34	WANDTKE I. (GER)
3	ARANDA OLALLA J. (ESP)	35	OSMANOV A. (MDA)
4	WANDTKE I. (GER)	36	ABDULAEV K. (UAE)
5	OSMANOV Adil (MDA)		
6	GREEN J. (IRL)		
7	DE LUCIA F. (ARG)		
8	ABDULAEV Karim (UAE)		

POOL B

9	CAZORLA O. (FRA)	37	CAZORLA O. (FRA)
10	KANG H. (KOR)	38	PARLATI M. (ITA)
11	TORNAL A. (DOM)	39	SHEROV A. (TJK)
12	PARLATI Manuel (ITA)	40	ANDREOU K. (CYP)
13	SHEROV A. (TJK)		
14	KODZHAKOV R. (BRN)		
15	ANDREOU K. (CYP)		
16	GALANDARZADE V. (AZE)		

POOL C

17	AKHADOV S. (UZB)	41	AKHADOV S. (UZB)
18	BLIMGOTOV B. (BRN)	42	NJIE F. (GAM)
19	ESTRADA M. (CUB)	43	MAMMADALIYEV R. (AZE)
20	NJIE Faye (GAM)	44	KANDEMIR B. (TUR)
21	MAMMADALIYEV R. (AZE)		
22	HEG K. (NED)		
23	MELLA E. (ITA)		
24	KANDEMIR B. (TUR)		

POOL D

25	STUMP N. (SUI)	45	STUMP N. (SUI)
26	LAVJARGAL A. (MGL)	46	TERADA M. (THA)
27	KVANTIDZE O. (POR)	47	PENA INSAUSTI J. (ESP)
28	TERADA M. (THA)	48	OLIN V. (FIN)
29	SHAMSHAYEV D. (KAZ)		
30	PENA INSAUSTI J. (ESP)		
31	DEMIREL U. (TUR)		
32	OLIN V. (FIN)		

REPECHAGE

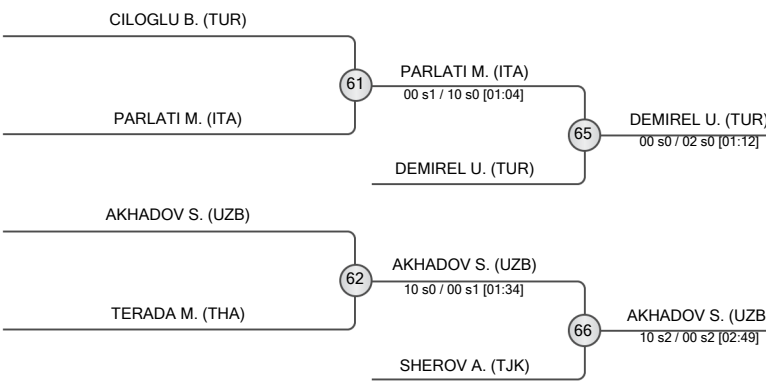

FINAL RESULTS		
1.	OSMANOV Adil	MDA
2.	MAMMADALIYEV Rashid	AZE
3.	DEMIREL Umalt	TUR
3.	AKHADOV Shakhram	UZB
5.	PARLATI Manuel	ITA
5.	SHEROV Abubakr	TJK
7.	CILOGLU Bilal	TUR
7.	TERADA Masayuki	THA





# Antalya Grand Slam 2024

Türkiye, Antalya, 29-31 Mar 2024

# -81 kg

## Men (61)

POOL A

1	SCHIMIDT Guilherme (BRA)	33	SCHIMIDT G. (BRA)
2	URQUIZA SOLANA Alfonso (ESP)	34	DEL ORBE CORTORREAL M. (DOM)
3	STEWART Max (JAM)	35	KARAPETYAN D. (AIN)
4	DEL ORBE CORTORREAL Medickson (DOM)	36	TATALASHVILI N. (UAE)
5	MOUTII Achraf (MAR)	37	NAGASE T. (JPN)
6	NUWARAPAKSHA Rajitha (SRI)	38	BOLTABOEV S. (UZB)
7	MAKINEN Oskari (FIN)	39	ALBAYRAK V. (TUR)
8	ZHUBANAZAR Abylaikhan (KAZ)	40	MOORHEAD L. (GBR)
9	KARAPETYAN David (AIN)	41	GAUTHIER DRAPEAU F. (CAN)
10	BONFERRONI Aurelien (SUI)	42	MURTOZOEV N. (UZB)
11	KOC Muhammed (TUR)	43	FERNANDO J. (POR)
12	TATALASHVILI Nugzari (UAE)	44	KHUBETSOV A. (AIN)
13	UNGVARI Attila (HUN)	45	STERPU V. (MDA)
14	SVIDRAK Mykhailo (UKR)	46	SIMSEK M. (TUR)
15	RESSEL Dominic (GER)	47	ESPOSITO A. (ITA)
16		48	GOCHILAI DZ E. (GEO)

POOL B

9	NAGASE Takanori (JPN)	51	NAGASE T. (JPN)
10	MORALES Tomas (ARG)	52	ALBAYRAK V. (TUR)
11	LEE Kwok Wing (HKG)	53	GAUTHIER DRAPEAU F. (CAN)
12	GERELTUUYA Bolor-Ochir (MGL)	54	FERNANDO J. (POR)
13	EGUTIDZE Anri (POR)	55	STERPU V. (MDA)
14	BOLTABOEV Sharofiddin (UZB)	56	ESPOSITO A. (ITA)
15	REBAHI Khalil (QAT)	57	KARAPETYAN D. (AIN)
16	HERKOVIC Nace (SLO)	58	NAGASE T. (JPN)
17	ALBAYRAK Vedat (TUR)	59	GAUTHIER DRAPEAU F. (CAN)
18	BERLINER Kell (USA)	60	ESPOSITO A. (ITA)
19	DVALASHVILI Zaur (GEO)	61	SCHIMIDT G. (BRA)
20	SOGENOV Islam (SRB)	62	FERNANDO J. (POR)
21	ABDELGHANY Abdelrahman (EGY)	63	NAGASE T. (JPN)
22	LATISEV Mihail (MDA)	64	GAUTHIER DRAPEAU F. (CAN)
23	PEREZ Jorge (CHI)	65	SCHIMIDT G. (BRA)
24	MOORHEAD Lachlan (GBR)	66	FERNANDO J. (POR)

POOL C

17	GAUTHIER DRAPEAU Francois (CAN)	61	SCHIMIDT G. (BRA)
18	DJALO Alpha Oumar (FRA)	62	FERNANDO J. (POR)
19	GRAMATIKOV Georgi (BUL)	63	NAGASE T. (JPN)
20	APRAHAMIAN Alain (URU)	64	GAUTHIER DRAPEAU F. (CAN)
21	CAVELIUS Timo (GER)	65	SCHIMIDT G. (BRA)
22	KALONGA Cedrick (COD)	66	FERNANDO J. (POR)
23	MURTOZOEV Nurbek (UZB)	67	NAGASE T. (JPN)
24	DE WIT Frank (NED)		
25	GOKCEN Niyazi (TUR)		
26	FERNANDO Joao (POR)		
27	RAJABLI Omar (AZE)		
28	DRZYMAL Pawel (POL)		
29	REBAHI Mohamed (QAT)		
30	ERDENEBAT Buyantsagaan (MGL)		
31	KHUBETSOV Alan (AIN)		

POOL D

25	MAKHMADBEKOV Somon (TJK)	45	STERPU V. (MDA)
26	STERPU Victor (MDA)	46	SIMSEK M. (TUR)
27	MASABIROV Asad (KGZ)	47	ESPOSITO A. (ITA)
28	MEDEIROS Pedro (BRA)	48	GOCHILAI DZ E. (GEO)
29	DUYCK Jarne (BEL)	49	SCHIMIDT G. (BRA)
30	DE RIDDER Maarten (NZL)	50	KARAPETYAN D. (AIN)
31	SIMSEK Musa (TUR)	51	NAGASE T. (JPN)
32	ESPOSITO Antonio (ITA)	52	ALBAYRAK V. (TUR)
33	MENDIOLA IZQUIETA Jose Maria (ESP)	53	GAUTHIER DRAPEAU F. (CAN)
34	FASCHING Bernd (AUT)	54	FERNANDO J. (POR)
35	MOHAMED Abdelrahman (EGY)	55	STERPU V. (MDA)
36	SULCA Adrian (ROU)	56	ESPOSITO A. (ITA)
37	KOLOBOV V. (UKR)	57	KARAPETYAN D. (AIN)
38	KOLOBOV Vladyslav (UKR)	58	NAGASE T. (JPN)
39	GOCHILAI DZ E. (GEO)	59	GAUTHIER DRAPEAU F. (CAN)
40	ALBALI Abdulelah (KSA)	60	ESPOSITO A. (ITA)

REPECHAGE

61	SCHIMIDT G. (BRA)	65	SCHIMIDT G. (BRA)
62	FERNANDO J. (POR)	66	FERNANDO J. (POR)
63	NAGASE T. (JPN)		
64	GAUTHIER DRAPEAU F. (CAN)		
65	SCHIMIDT G. (BRA)		
66	FERNANDO J. (POR)		

### FINAL RESULTS

- NAGASE Takanori (JPN)
- GAUTHIER DRAPEAU Francois (CAN)
- SCHIMIDT Guilherme (BRA)
- FERNANDO Joao (POR)
- ESPOSITO Antonio (ITA)
- KARAPETYAN David (AIN)
- ALBAYRAK Vedat (TUR)
- STERPU Victor (MDA)





# Antalya Grand Slam 2024

Türkiye, Antalya, 29-31 Mar 2024

## -90 kg

Men (55)

POOL A

1	SILVA MORALES Ivan Felipe CUB	1	SILVA MORALES I. (CUB)	33	SILVA MORALES I. (CUB)
2	TRIPPEL Eduard GER	2	TRIPPEL E. (GER)	10 s0 / 00 s0 [00:00]	10 s0 / 00 s3 [05:12]
3	GANTULGA Altanbagana MGL	3	FLORENTINO R. (DOM)	00 s2 / 01 s2 [04:00]	
4	CUHADAR Ahmet TUR	4	FLORENTINO R. (DOM)	01 s2 / 00 s2 [05:09]	
5	FLORENTINO Robert DOM	5	TSELEDIS T. (GRE)		
6	MOSAKHLISHVILI Tristani ESP	6	TALIBOV V. (AZE)	00 s0 / 10 s0 [00:00]	
7	FOUBERT Karel BEL	7	GRIGORIAN A. (UAE)	00 s0 / 02 s0 [02:49]	
8	TSELEDIS Theodoros GRE	8	DACOSTA R. (SEN)	00 s0 / 10 s0 [00:21]	
9	TALIBOV Vugar AZE	9	TALIBOV V. (AZE)	01 s2 / 00 s2 [04:00]	
10	SIDORYK Aliaksandr AIN	10	GRIGORIAN A. (UAE)	11 s1 / 00 s0 [01:03]	
11	NYMAN Marcus SWE	11	GRIGORIAN A. (UAE)		
12	GRIGORIAN Aram UAE	12	DACOSTA R. (SEN)		
13	GUNCHENKO Stanislav UKR	13	DACOSTA R. (SEN)		
14	DACOSTA Ryan SEN	14	DACOSTA R. (SEN)		

POOL B

9	ZGANK Mihael TUR	9	ZGANK M. (TUR)	37	ZGANK M. (TUR)
10	MALKIN Egor AIN	10	HAN J. (KOR)	00 s0 / 10 s1 [01:41]	10 s2 / 00 s3 [04:54]
11	HAN Juyeop KOR	11	MILETIC T. (BIH)	00 s3 / 10 s1 [02:27]	
12	GALARRETA Yuta PER	12	BABUTSIDZE L. (GEO)	00 s2 / 02 s2 [02:36]	
13	MILETIC Toni BIH	13	SHEROV E. (KGZ)		
14	BABUTSIDZE Luka GEO	14	GOMES M. (BRA)	00 s3 / 10 s2 [06:32]	
15	MARAEV Sulim BRN	15	NGAYAP HAMBOU M. (FRA)	10 s1 / 00 s3 [03:07]	
16	SHEROV Erlan KGZ	16	ZILKA P. (SVK)	01 s1 / 00 s2 [04:00]	
17	GOMES Marcelo BRA	17	GOMES M. (BRA)	10 s2 / 00 s3 [05:02]	
18	KLAMMERT David CZE	18	NGAYAP HAMBOU M. (FRA)		
19	NGAYAP HAMBOU Maxime-Gael FRA	19	NGAYAP HAMBOU M. (FRA)	10 s1 / 00 s3 [03:07]	
20	RAJABOV Umedjon TJK	20	ZILKA P. (SVK)	01 s1 / 00 s2 [02:07]	
21	ZILKA Peter SVK	21	ZILKA P. (SVK)		
22	CRET Alex ROU	22	ZILKA P. (SVK)		

POOL C

17	MURAO Sanshiro JPN	17	MURAO S. (JPN)	41	MURAO S. (JPN)
18	GUZEL Can TUR	18	GUZEL C. (TUR)	10 s0 / 00 s0 [00:28]	
19	ACHYLDYYEV Mamedaly TKM	19	KALJULAI K. (EST)	10 s1 / 00 s3 [03:20]	
20	KALJULAI Klen Kristofer EST	20	EDILSULTANOV I. (AIN)	00 s2 / 02 s2 [03:54]	
21	ERASHVILI Bakar GEO	21	VAN T END N. (NED)		
22	YUDANOV Nikita UKR	22	USTOPIRIYON K. (TJK)	00 s3 / 10 s2 [05:09]	
23	EDILSULTANOV Ikhvan AIN	23	USTOPIRIYON K. (TJK)	01 s1 / 00 s0 [04:00]	
24	VAN T END Noel NED	24	SAFRANY P. (HUN)	01 s2 / 11 s1 [02:57]	
25	USTOPIRIYON Komronshokh TJK	25	SAFRANY P. (HUN)	00 s1 / 10 s1 [03:33]	
26	PETGRAVE Jamal GBR	26	SAFRANY P. (HUN)		
27	VISAN Vlad ROU	27	SAFRANY P. (HUN)		
28	BARTO Alex SVK	28	SAFRANY P. (HUN)		
29	BRASNJOVIC Darko SRB	29	SAFRANY P. (HUN)		
30	SAFRANY Peter HUN	30	SAFRANY P. (HUN)		

POOL D

25	BOBONOV Davlat UZB	25	BOBONOV D. (UZB)	45	BOBONOV D. (UZB)
26	LEE Sungho KOR	26	LEE S. (KOR)	11 s0 / 00 s0 [01:24]	
27	SCHARFETTER Thomas AUT	27	KRIEBER GAGNON L. (CAN)	11 s0 / 00 s1 [02:44]	
28	KRIEBER GAGNON Louis CAN	28	NIETO TRINIDAD D. (ESP)	00 s3 / 10 s2 [03:04]	
29	DEMIRTAS Cem TUR	29	MACEDO R. (BRA)	11 s1 / 00 s0 [02:37]	
30	NIETO TRINIDAD Daniel ESP	30	MACEDO R. (BRA)	10 s1 / 00 s0 [01:28]	
31	ANUARBEKOV Yermakhan KAZ	31	MACEDO R. (BRA)		
32	MACEDO Rafael BRA	32	MACEDO R. (BRA)		
33	DIAO Abderahmane SEN	33	MATIJASS M. (GER)	00 s0 / 11 s1 [03:52]	
34	MATIJASS Martin GER	34	CHOUCHI S. (BEL)	00 s3 / 10 s1 [04:19]	
35	COTO BERSIER Mariano ARG	35	CHOUCHI S. (BEL)	10 s0 / 00 s2 [01:07]	
36	CHOUCHI Sami BEL	36	GINI A. (PAR)		
37	GINI Angel Antonio PAR	37	GINI A. (PAR)		

REPECHAGE

61	SILVA MORALES I. (CUB)	61	SILVA MORALES I. (CUB)	65	SILVA MORALES I. (CUB)
62	NGAYAP HAMBOU M. (FRA)	62	SAFRANY P. (HUN)	10 s1 / 00 s1 [01:28]	
63	TALIBOV V. (AZE)	63	TALIBOV V. (AZE)	10 s0 / 00 s3 [02:51]	
64	MURAO S. (JPN)	64	MURAO S. (JPN)	11 s0 / 00 s1 [03:57]	
65	BOBONOV D. (UZB)	65	BOBONOV D. (UZB)	02 s1 / 00 s2 [03:12]	
66	ZGANK M. (TUR)	66	ZGANK M. (TUR)	00 s2 / 10 s2 [02:16]	

FINAL RESULTS		
1.	MURAO Sanshiro	JPN
2.	TALIBOV Vugar	AZE
3.	SILVA MORALES Ivan Felipe	CUB
4.	ZGANK Mihael	TUR
5.	BOBONOV Davlat	UZB
6.	SAFRANY Peter	HUN
7.	NGAYAP HAMBOU Maxime-Gael	FRA
8.	MACEDO Rafael	BRA





# Antalya Grand Slam 2024

Türkiye, Antalya, 29-31 Mar 2024

# -100 kg

## Men (48)

POOL A

1	KORREL Michael (NED)	1	KORREL M. (NED)
2	JAPARIDZE Mikheil (GEO)	2	GONZALEZ A. (ROU)
3	GONZALEZ Asley (ROU)	3	KIM S. (KOR)
4	KEEVE Nathaniel (USA)	4	DICHEV D. (BUL)
5	KIM Seheon (KOR)	5	FONSECA J. (POR)
6	DICHEV Daniel (BUL)	6	SHORAKHMATOV R. (UZB)
7	FONSECA Jorge (POR)	7	UDSILAURO G. (GER)
8	SHORAKHMATOV Rustam (UZB)	8	DOSEN B. (SRB)
	BEZZINA Isaac (MLT)		
	UDSILAURO George (GER)		
	AVTAR SINGH (IND)		
	DOSEN Bojan (SRB)		

POOL B

9	ADAMIAN Arman (AIN)	9	ADAMIAN A. (AIN)
10	PIRELLI Gennaro (ITA)	10	PIRELLI G. (ITA)
11	SISMANLAR Mert (TUR)	11	SAVYTSKIY A. (UKR)
12	DUINOV S Maksims (LAT)	12	ABDURAKHMONOV P. (TJK)
13	SAVYTSKIY Anton (UKR)	13	BATKHUYAG G. (MGL)
14	ABDURAKHMONOV Parviz (TJK)	14	MADSEN M. (DEN)
15	BATKHUYAG Gonchigsuren (MGL)	15	SHARKHAN Nurlykhan (KAZ)
16	MADSEN Mathias (DEN)	16	BUZACARINI R. (BRA)
	SHARKHAN Nurlykhan (KAZ)		
	BUZACARINI Rafael (BRA)		
	VEG Zsombor (HUN)		
	EICH Daniel (SUI)		

POOL C

17	ELNAHAS Shady (CAN)	17	ELNAHAS S. (CAN)
18	MAI Louis (GER)	18	MAI L. (GER)
19	WON Jonghoon (KOR)	19	SARSENBAEV E. (UZB)
20	SARSENBAEV Ernazar (UZB)	20	NIKIFOROV T. (BEL)
21	BALANTA Francisco (COL)	21	NIKIFOROV T. (BEL)
22	NIKIFOROV Toma (BEL)	22	KUKOLJ A. (SRB)
23	KUKOLJ Aleksandar (SRB)	23	HUTSOL D. (UKR)
24	HUTSOL Danylo (UKR)	24	YAPICI Suat Can (TUR)
	YAPICI Suat Can (TUR)		
	MATASEJE Benjamin (SVK)		
	KUMRIC Zlatko (CRO)		
	CATHARINA Simeon (NED)		

POOL D

25	REYES Kyle (CAN)	25	REYES K. (CAN)
26	BILALOV Niiaz (AIN)	26	WOLF A. (JPN)
27	WOLF Aaron (JPN)	27	THOMPSON R. (GBR)
28	THOMPSON Rhys (GBR)	28	GEORGIEV B. (BUL)
29	BOEHLER Laurin (AUT)	29	GEORGIEV B. (BUL)
30	GEORGIEV Boris (BUL)	30	GONCALVES L. (BRA)
31	GONCALVES Leonardo (BRA)	31	SAPARGALIYEV A. (KAZ)
32	MAJANOV Baymyrat (TKM)	32	MADZHIDOV D. (TJK)
	SAPARGALIYEV Adilet (KAZ)		
	BASHAEV Zelimkhan (BRN)		
	MADZHIDOV Dzhakhongir (TJK)		
	KILIC Adnan (TUR)		

REPECHAGE

61	KORREL M. (NED)	61	BATKHUYAG G. (MGL)		
	BATKHUYAG G. (MGL)				
			65	BATKHUYAG G. (MGL)	
				GONCALVES L. (BRA)	
			62	WOLF A. (JPN)	
				WOLF A. (JPN)	
				66	WOLF A. (JPN)
					ADAMIAN A. (AIN)

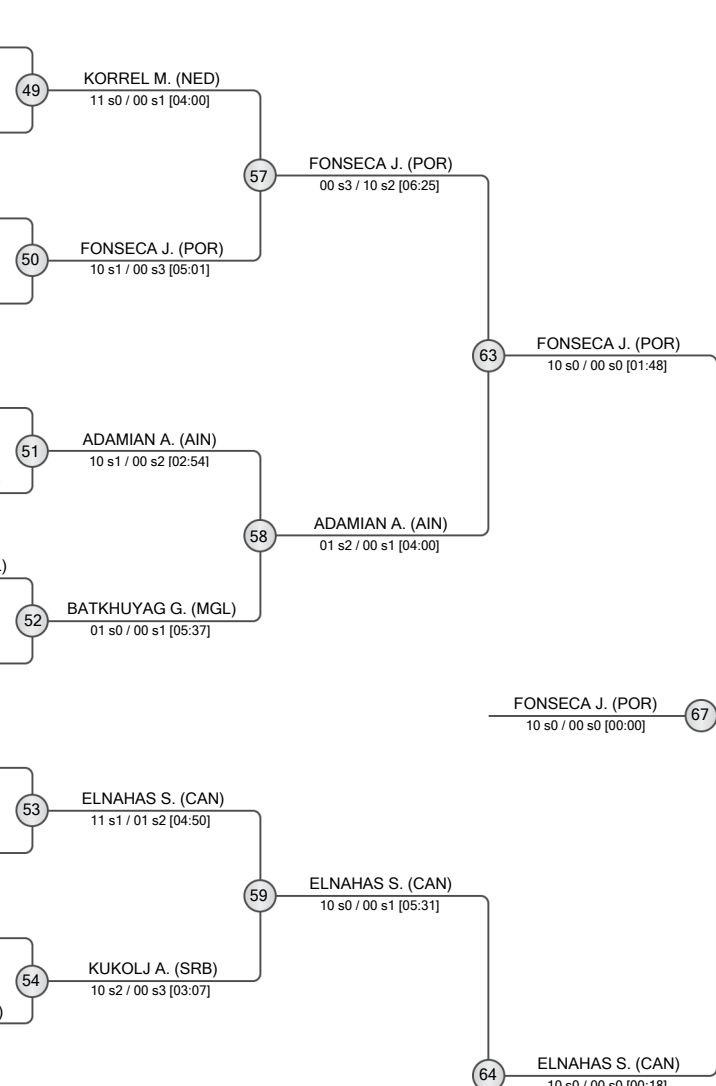

FINAL RESULTS		
1.	FONSECA Jorge	POR
2.	ELNAHAS Shady	CAN
3.	BATKHUYAG Gonchigsuren	MGL
3.	WOLF Aaron	JPN
5.	GONCALVES Leonardo	BRA
5.	ADAMIAN Arman	AIN
7.	KORREL Michael	NED
7.	KUKOLJ Aleksandar	SRB





# Antalya Grand Slam 2024

Türkiye, Antalya, 29-31 Mar 2024

## +100 kg

Men (40)

POOL A

	GRANDA Andy	CUB
	TUTAR Tunahan	TUR
	FIZEL Marius	SVK
	GADEAU Marvin	MON
	DEMETRASHVILI Irakli	GEO
	ODKHUU Tsetsentsengel	MGL
	KONE Losseni	GER
	MARINIC Enej	SLO
	ENDOVITSKIY Valeriy	AIN
	KAZHYBAYEV Yerassyl	KAZ

1	GRANDA A. (CUB)
2	FIZEL M. (SVK)
3	GADEAU M. (MON)
4	DEMETRASHVILI I. (GEO)
5	ODKHUU T. (MGL)
6	MARINIC E. (SLO)
7	ENDOVITSKIY V. (AIN)
8	KAZHYBAYEV Y. (KAZ)

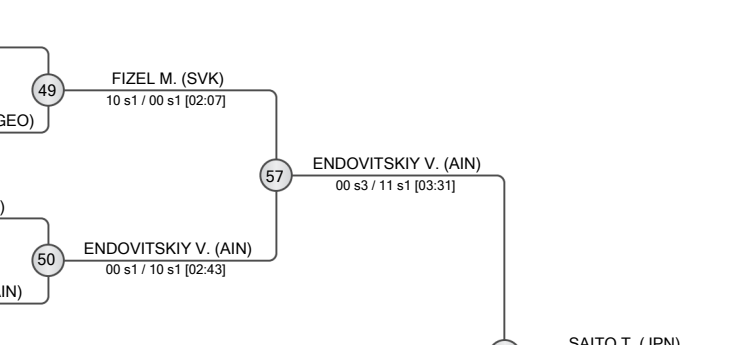

POOL B

	SAITO Tatsuru	JPN
	SZCZUROWSKI Kacper	POL
	VRACAR Igor	SRB
	MANE Bubacar	GBS
	MANAIE Saud	KSA
	SNIPPE Jelle	NED
	GAMZATKHANOV Dzhama	AZE
	ERGIN Recep	TUR
	BORCHASHVILLI Movli	AUT
	BAKHTIYOROV Shokhrukhkhon	UZB

9	SAITO T. (JPN)
10	SZCZUROWSKI K. (POL)
11	VRACAR I. (SRB)
12	MANAIE S. (KSA)
13	SNIPPE J. (NED)
14	GAMZATKHANOV D. (AZE)
15	BORCHASHVILLI M. (AUT)
16	BAKHTIYOROV S. (UZB)

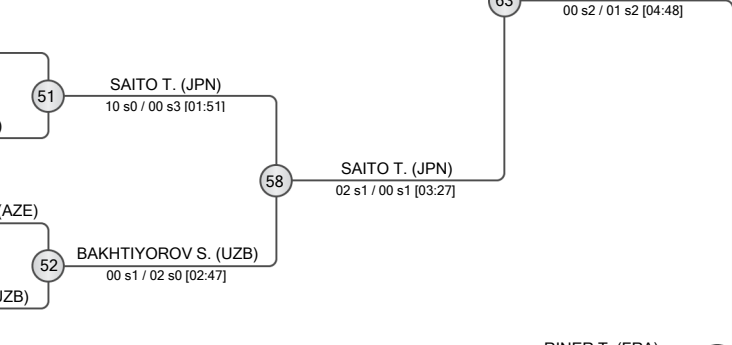

POOL C

	PUUMALAINEN Martti	FIN
	NDIAYE Mbagnick	SEN
	MASSANGA Valentino	COD
	DRAGIC Vito	SLO
	USUKHBAYAR Perenleijamts	MGL
	KOKAURI Ushangi	AZE
	ANTONIOU Giannis	CYP
	LILI Mohamed El Mehdi	ALG
	BALYEVSYY Yevheniy	UKR
	ABRAMOV Erik	GER

17	PUUMALAINEN M. (FIN)
18	NDIAYE M. (SEN)
19	DRAGIC V. (SLO)
20	USUKHBAYAR P. (MGL)
21	KOKAURI U. (AZE)
22	ANTONIOU G. (CYP)
23	BALYEVSYY Y. (UKR)
24	ABRAMOV E. (GER)

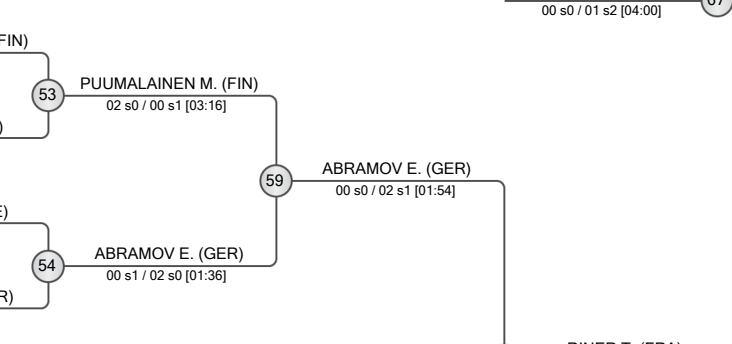

POOL D

	RINER Teddy	FRA
	CHOTCHAEV Azamat	BRN
	TERESINSKI Grzegorz	POL
	SPIJKERS Jur	NED
	LAHBOUB Mohammed	MAR
	SILVA Rafael	BRA
	DUBRETA Anto	MNE
	PRIILINN TURK Karl	EST
	GUNER Furkan	TUR
	KRIKBAY Galymzhan	KAZ

25	RINER T. (FRA)
26	CHOTCHAEV A. (BRN)
27	SPIJKERS J. (NED)
28	LAHBOUB M. (MAR)
29	SILVA R. (BRA)
30	DUBRETA A. (MNE)
31	PRIILINN TURK K. (EST)
32	KRIKBAY G. (KAZ)

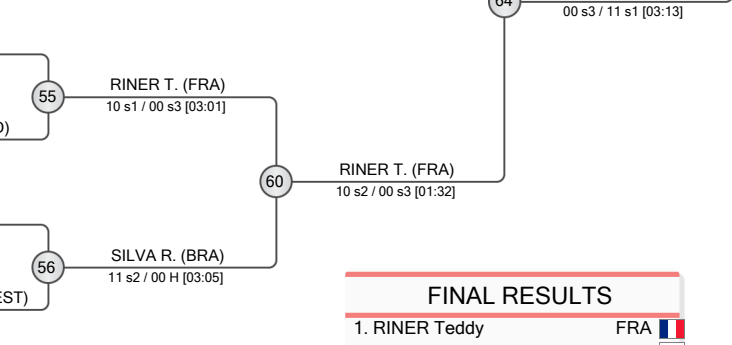

REPECHAGE

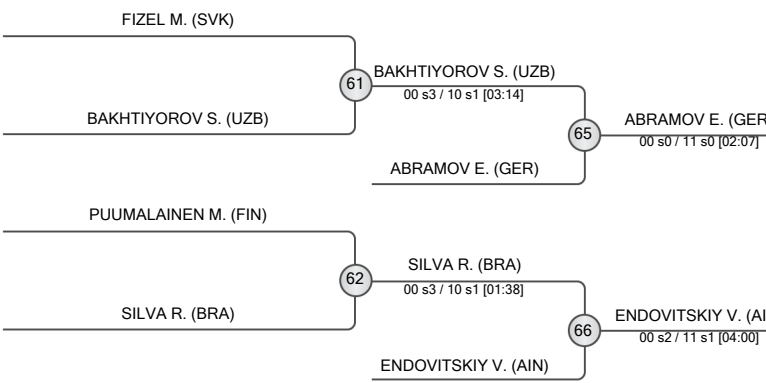

### FINAL RESULTS

1.	RINER Teddy	FRA
2.	SAITO Tatsuru	JPN
3.	ABRAMOV Erik	GER
3.	ENDOVITSKIY Valeriy	AIN
5.	BAKHTIYOROV Shokhrukhkhon	UZB
5.	SILVA Rafael	BRA
7.	FIZEL Marius	SVK
7.	PUUMALAINEN Martti	FIN







# Antalya Grand Slam 2024

Türkiye, Antalya, 29-31 Mar 2024

# -48 kg

## Women (42)

POOL A

1	SCUTTO Assunta (ITA)	33	SCUTTO A. (ITA)	02 s0 / 00 s0 [01:47]
2	MENZ Katharina (GER)	34	ERSIN S. (TUR)	00 s3 / 10 s0 [04:57]
3	GUO Zongying (CHN)	34	ERSIN S. (TUR)	11 s0 / 00 s3 [03:21]
4	ERSIN Sila (TUR)			
5	WONG Ka Lee (HKG)			
5	GILIAZOVA Sabina (AIN)	35	GILIAZOVA S. (AIN)	01 s1 / 00 s2 [07:12]
6	SPRINGER Jacqueline (AUT)			
7	KURBANOVA Kurbanay (TKM)	36	PETIT L. (BEL)	00 s0 / 02 s1 [02:26]
8	PETIT Lois (BEL)			
	MORAND Priscilla (MRI)		MORAND P. (MRI)	11 s1 / 00 s2 [02:29]

POOL B

9	GANBAATAR Narantsetseg (MGL)	37	GANBAATAR N. (MGL)	10 s1 / 00 s3 [02:49]
10	LEGOUX CLEMENT Melanie (FRA)			
11	SOLIS Jacqueline (GUA)			
12	GERSJES Amber (NED)	38	GERSJES A. (NED)	01 s1 / 00 s0 [04:00]
13	WHITEBOOI Geronay (RSA)			
14	LIN Chen-Hao (TPE)			
13	BAVUUDORJ Baasankhuu (MGL)	39	AZAK M. (TUR)	00 s0 / 10 s1 [02:21]
14	AZAK Merve (TUR)			
15	LIMA Amanda (BRA)			
16	NARVAEZ Gabriela (PAR)	40	NARVAEZ G. (PAR)	11 s2 / 00 s3 [02:12]
16	BURKEYEVA Diana (KAZ)			

POOL C

17	TSUNODA Natsumi (JPN)	41	TSUNODA N. (JPN)	02 s1 / 00 s2 [02:33]
18	AYMARD Virginia (GAB)			
19	HO Lok Yi (HKG)	42	STANGAR M. (SLO)	00 s0 / 02 s2 [02:44]
20	BEDER Tugce (TUR)			
21	STANGAR Marusa (SLO)			
21	LAPUERTA COMAS Mireia (ESP)	43	LAPUERTA COMAS M. (ESP)	10 s1 / 00 s3 [03:26]
22	ESPOSITO Katryna (MLT)			
23	PERROT Anais (FRA)			
24	FERREIRA Natasha (BRA)	44	FERREIRA N. (BRA)	10 s1 / 00 s2 [04:35]
24	LASSO Erika (COL)			

POOL D

25	ABUZHAKYNOVA Abiba (KAZ)	45	ABUZHAKYNOVA A. (KAZ)	02 s1 / 00 s2 [02:54]
26	BRITO Raquel (POR)			
27	CARRILLO Edna (MEX)			
28	DUDINA Kristina (AIN)	46	DUDINA K. (AIN)	10 s0 / 01 s2 [03:12]
28	HUI Xinran (CHN)			
29	LABORDE Maria Celia (USA)	47	LABORDE M. (USA)	01 s1 / 00 s0 [04:00]
30	SHEN Yi-Chun (TPE)			
31	TANZER Katharina (AUT)			
32	VARGAS LEY Mary Dee (CHI)	48	VARGAS LEY M. (CHI)	01 s0 / 00 s2 [05:21]
32	SERDAR Cagla (TUR)			
	PERAFAN Keisy (ARG)			

REPECHAGE

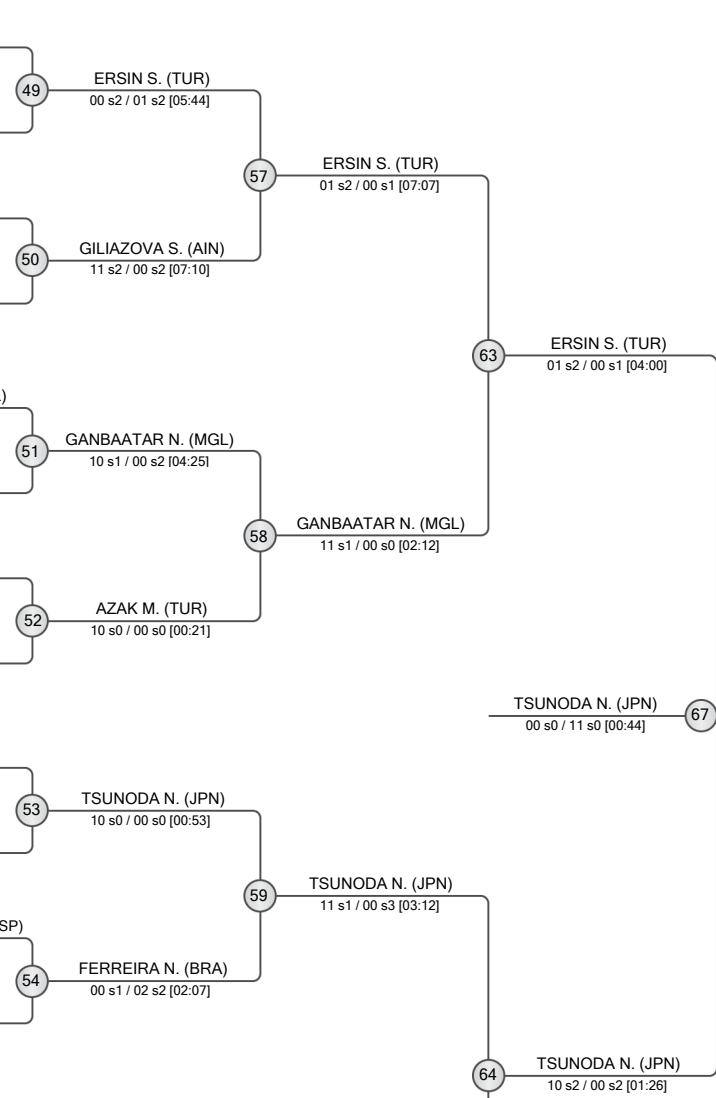
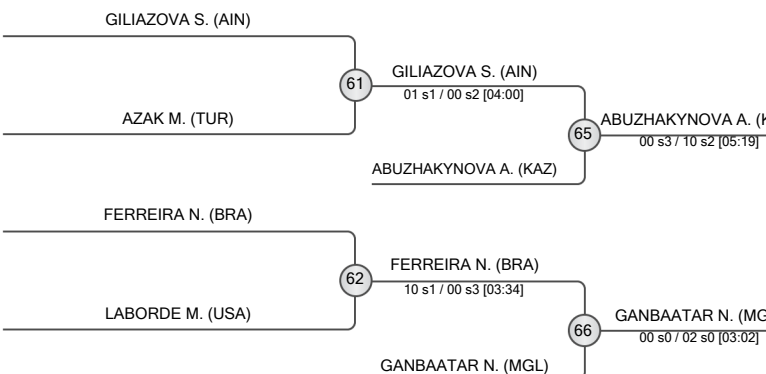

FINAL RESULTS		
1.	TSUNODA Natsumi	JPN
2.	ERSIN Sila	TUR
3.	ABUZHAKYNOVA Abiba	KAZ
3.	GANBAATAR Narantsetseg	MGL
5.	GILIAZOVA Sabina	AIN
5.	FERREIRA Natasha	BRA
7.	AZAK Merve	TUR
7.	LABORDE Maria Celia	USA





# Antalya Grand Slam 2024

Türkiye, Antalya, 29-31 Mar 2024

## -52 kg

### Women (38)

POOL A

1	GIUFFRIDA Odette (ITA)	33	GIUFFRIDA O. (ITA)
2	CHOPADEV Shradha Kadubal (IND)	34	WURFEL A. (GER)
3	ASVESTA Sofia (CYP)	35	KADAMBOEVA S. (UZB)
4	JANG Seyun (KOR)	36	BORISOVA G. (AIN)
5	WURFEL Annika (GER)	37	ABE U. (JPN)
6	KADAMBOEVA Sita (UZB)	38	NDIAYE B. (SUI)
7	GYERTYAS Roza (HUN)	39	MARTINEZ P. (MEX)
8	BORISOVA Glafira (AIN)	40	DEGUCHI K. (CAN)
	LOPEZ SHERIFF Estrella (ESP)		FIORA S. (ARG)
	SHEN Yi-Hsi (TPE)		

POOL B

9	ABE Uta (JPN)	41	GILES C. (GBR)
10	ABEUOVA Tolganay (KAZ)	42	PEREIRA J. (BRA)
11	CINCI Zeliha (TUR)	43	ZHU Y. (CHN)
12	KARLIKOVA Nasiba (TJK)	44	KOCHER F. (SUI)
13	NDIAYE Binta (SUI)	45	PUPP R. (HUN)
14	PIMENTA Larissa (BRA)	46	LEIVA SANCHEZ A. (ESP)
15	MARTINEZ Paulina (MEX)	47	PULJIZ A. (CRO)
16	DEGUCHI Kelly (CAN)	48	DELGADO A. (USA)
	FIORA Sofia (ARG)		DANILOVICH Kseniya (AIN)
			JURAEVA G. (UZB)

POOL C

17	GILES Chelsie (GBR)	49	GIUFFRIDA O. (ITA)
18	CARBONELL JULIAN Aleanny (CUB)	50	KADAMBOEVA S. (UZB)
19	JUNG Yerin (KOR)	51	ABE U. (JPN)
20	RYHEUL Amber (BEL)	52	DEGUCHI K. (CAN)
21	PEREIRA Jessica (BRA)	53	GILES C. (GBR)
22	ZHU Yeqing (CHN)	54	ZHU Y. (CHN)
23	KALETA Aleksandra (POL)	55	LEIVA SANCHEZ A. (ESP)
24	MUMINOVA Akhliya (TJK)	56	PULJIZ A. (CRO)
	TUNCA Ayse Nur (TUR)		DELGADO A. (USA)
	KOCHER Fabienne (SUI)		JURAEVA G. (UZB)

POOL D

25	PUPP Reka (HUN)	57	GIUFFRIDA O. (ITA)
26	DIMITROVA Gabriela (BUL)	58	ABE U. (JPN)
27	SIDEROT Maria (POR)	59	GILES C. (GBR)
28	LEIVA SANCHEZ Ayumi (ESP)	60	LEIVA SANCHEZ A. (ESP)
29	BISHRELT Khorloodoi (UAE)	61	KADAMBOEVA S. (UZB)
30	PULJIZ Ana Viktorija (CRO)	62	PULJIZ A. (CRO)
31	DELGADO Angelica (USA)	63	ABE U. (JPN)
32	DANILOVICH Kseniya (AIN)	64	GILES C. (GBR)
	JURAEVA G. (UZB)		

REPECHAGE

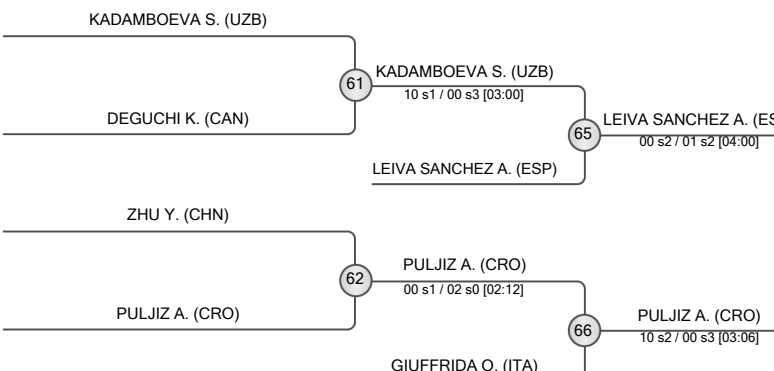

FINAL RESULTS	
1.	ABE Uta (JPN)
2.	GILES Chelsie (GBR)
3.	LEIVA SANCHEZ Ayumi (ESP)
3.	PULJIZ Ana Viktorija (CRO)
5.	KADAMBOEVA Sita (UZB)
5.	GIUFFRIDA Odette (ITA)
7.	DEGUCHI Kelly (CAN)
7.	ZHU Yeqing (CHN)





# Antalya Grand Slam 2024

Türkiye, Antalya, 29-31 Mar 2024

## -57 kg

### Women (44)

POOL A

1	DEGUCHI Christa (CAN)	2	DEGUCHI C. (CAN)
2	KALLINGER Laura (AUT)	33	DEGUCHI C. (CAN)
3	ESTEVEZ Mariana (GUI)	10 s0 / 00 s3 [04:54]	
4	KARADAG Aysenur (TUR)	49	DEGUCHI C. (CAN)
5	KOWALCZYK Julia (POL)	02 s1 / 00 s1 [01:04]	
6	SMYTHE-DAVIS Nekoda (GBR)	34	ESTEVEZ M. (GUI)
7	YEUNG Nok Lam (HKG)	01 s1 / 00 s1 [04:00]	
8	KUSSAKBAYEVA Bakyt (KAZ)	35	SMYTHE-DAVIS N. (GBR)
9	UBASART MASCARO Carla (ESP)	10 s2 / 00 s3 [02:57]	
10	CHYZHEVSKA Anastasiia (UKR)	50	KIM J. (KOR)
11	KIM Juhee (KOR)	00 s2 / 01 s1 [04:16]	
12		36	KIM J. (KOR)
13		00 s0 / 02 s1 [02:41]	

POOL B

9	TONIOLO Veronica (ITA)	10	TONIOLO V. (ITA)
10	OYUNGEREL Oyunchimeg (MGL)	37	TONIOLO V. (ITA)
11	MUKHINA Olga (AIN)	10 s2 / 00 s3 [04:24]	
12	MOKDAR Faiza (FRA)	51	MOKDAR F. (FRA)
13	SALONEN Pihla (FIN)	00 s0 / 11 s1 [01:25]	
14	STARKE Pauline (GER)	38	MOKDAR F. (FRA)
15	AMINOVA Shukurjon (UZB)	10 s0 / 00 s3 [03:41]	
16	BUDAK Aysenur (TUR)	39	STARKE P. (GER)
17	NGUYEN Ngoc Diem Phuong (VIE)	10 s2 / 00 s3 [05:29]	
18	PARDAYEVA Maysa (TKM)	52	PARDAYEVA M. (TKM)
19	PARDAYEVA Maysa (TKM)	00 s1 / 10 s1 [01:04]	
20	MARTIN Jasmine (RSA)	40	PARDAYEVA M. (TKM)
21		02 s0 / 01 s1 [02:38]	

POOL C

17	SILVA Rafaela (BRA)	18	SILVA R. (BRA)
18	TOPOLOVEC Tihea (CRO)	41	TOPOLOVEC T. (CRO)
19	BOZKURT Hasret (TUR)	01 s1 / 00 s2 [04:00]	
20	GOMEZ Brisa (ARG)	53	PODOLAK A. (POL)
21	PODOLAK Arleta (POL)	00 s3 / 10 s1 [03:22]	
22	CAI Qi (CHN)	42	PODOLAK A. (POL)
23	WILSON CLARET Malin (ESP)	00 s2 / 01 s1 [04:00]	
24	MATIKAINEN Pihla (FIN)	43	CAI Q. (CHN)
25	NAIRNE Lele (GBR)	10 s2 / 00 s2 [06:03]	
26	GALITSKAIA Kseniia (AIN)	54	CAI Q. (CHN)
27	GALITSKAIA Anastasiia (LAT)	10 s1 / 00 s3 [03:17]	
28	SOKIRJANSKA Anastasiia (LAT)	44	SOKIRJANSKA A. (LAT)
29		00 H / 11 s0 [02:21]	

POOL D

25	LIMA Jessica (BRA)	26	LIMA J. (BRA)
26	JIMENEZ Kristine (PAN)	45	LIMA J. (BRA)
27	SAMARDZIC Andjela (BIH)	10 s1 / 00 s1 [02:21]	
28	CAPANNI DIAS Thauany David (ITA)	55	LIMA J. (BRA)
29	MOURYA Yamini (IND)	10 s0 / 00 H [00:30]	
30	LIEN Chen-Ling (TPE)	46	CAPANNI DIAS T. (ITA)
31	YILDIZ Ozlem (TUR)	10 s0 / 00 s3 [03:43]	
32	MUNKHTSEDEV Ichinkhorloo (MGL)	47	YILDIZ O. (TUR)
33	GRABNER Lisa (AUT)	10 s2 / 00 s3 [07:38]	
34	BALLHAUS Seija (GER)	56	BALLHAUS S. (GER)
35	HOLGUIN Mariah (USA)	00 s3 / 10 s2 [04:57]	
36		00 s1 / 02 s2 [04:00]	

REPECHAGE

61	PARDAYEVA M. (TKM)	62	BALLHAUS S. (GER)
63	CAI Q. (CHN)	00 s1 / 10 s2 [04:08]	
64	LIMA J. (BRA)	66	MOKDAR F. (FRA)
65	PARDAYEVA M. (TKM)	00 s1 / 01 s2 [04:00]	
66	MOKDAR F. (FRA)		

67  
DEGUCHI C. (CAN)  
10 s2 / 00 s2 [04:51]

### FINAL RESULTS

1.	DEGUCHI Christa	CAN	
2.	LIMA Jessica	BRA	
3.	PARDAYEVA Maysa	TKM	
3.	MOKDAR Faiza	FRA	
5.	CAI Qi	CHN	
5.	BALLHAUS Seija	GER	
7.	KIM Juhee	KOR	
7.	PODOLAK Arleta	POL	





# Antalya Grand Slam 2024

Türkiye, Antalya, 29-31 Mar 2024

## -63 kg

### Women (43)

POOL A

1	BEAUCHEMIN-PINARD Catherine	CAN
2	PADILLA GUERRERO Sarai	ESP
3	BADUROVA Kamila	AIN
4	DEL TORO CARVAJAL Maylin	CUB
5	AFYONLU Habibe	TUR
6	KRISTO Katarina	CRO
7	POHL Dena	GER
8	ANTIPINA Anastasiia	UKR
	MANOVA Yoana	BUL
	AUCHECORNE Melkia	FRA

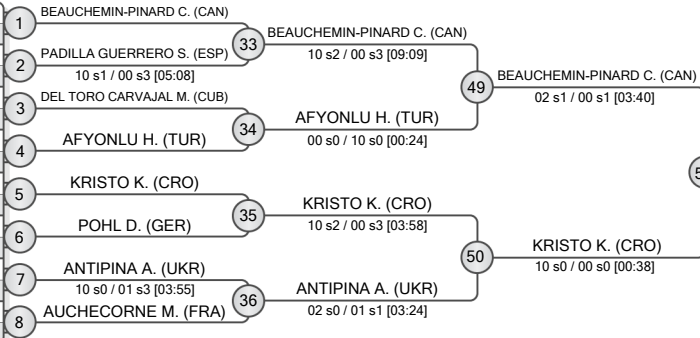

POOL B

9	TIMO Barbara	POR
10	YEKSAN Ayten	TUR
11	OBRADOVIC Anja	SRB
12	IVANESCU Florentina	ROU
13	KRSSAKOVA Magdalena	AUT
14	WATANABE Kiyomi	PHI
15	QUADROS Ketleyn	BRA
16	RUSSO Savita	ITA
17	KROPSKA Natalia	POL
18	LILUASHVILI Dali	AIN
19	BAKHANOVA Gulnur	KAZ

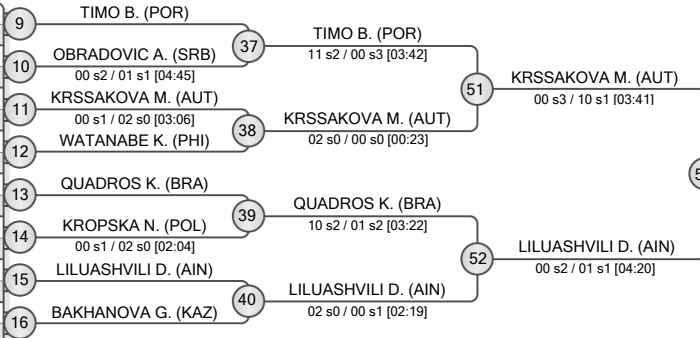

POOL C

17	TAKAICHI Miku	JPN
18	KARADEMIR Ezgi	TUR
19	SILVA Nauana	BRA
20	FAVORINI Flavia	ITA
21	HREBENOZHKO Yuliia	UKR
22	BUNCIC Jovana	SRB
23	TANG Jing	CHN
24	CORRAO Alessia	BEL
25	MARTIN Hannah	USA
26	TOKAS Himanshi	IND
27	SCHMIDT Agatha	GER

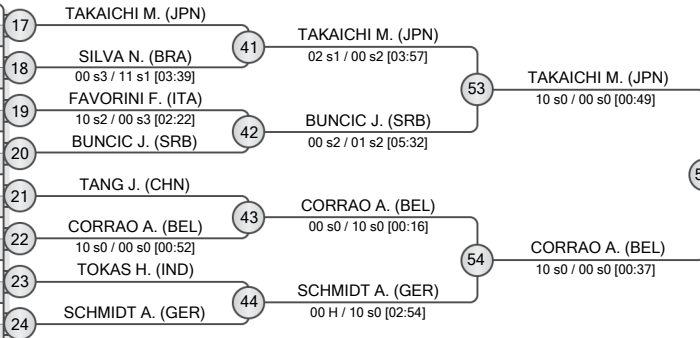

POOL D

25	RENSHALL Lucy	GBR
26	MAKRETSKAYA Yana	AIN
27	SANCHEZ BENITEZ Ariela	ESP
28	KIM Jisu	KOR
29	DASHKINOVA Zulhumar	TKM
30	BELKADI Amina	ALG
31	PIOVESANA Lubjana	AUT
32	AKDENIZ Minel	TUR
33	YERGALIYEVA Samalay	KAZ
34	OBERAN Iva	CRO
35	BOLD Gankhaich	MGL

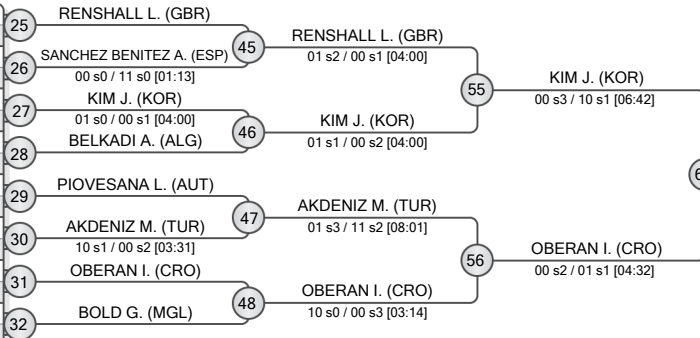

FINAL RESULTS	
1.	KIM Jisu KOR
2.	LILUASHVILI Dali AIN
3.	TAKAICHI Miku JPN
3.	KRISTO Katarina CRO
5.	KRSSAKOVA Magdalena AUT
5.	OBERAN Iva CRO
7.	BEAUCHEMIN-PINARD Catherine CAN
7.	CORRAO Alessia BEL

REPECHAGE

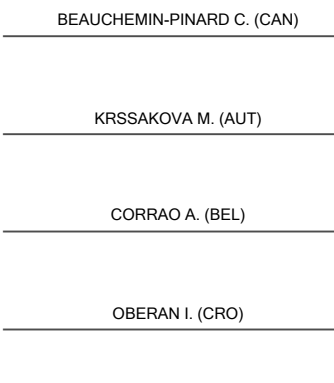



# Antalya Grand Slam 2024

Türkiye, Antalya, 29-31 Mar 2024

## -70 kg

### Women (41)

POOL A

	BUTKEREIT Miriam	GER
	TOKAREVA Ekaterina	KAZ
	YU Dan	CHN
	POLLING Kim	NED
	ESPOSITO Martina	ITA
	MATNIYAZOVA Gulnoza	UZB
	RASOANAIVO RAZAFY Aina-Laura	MAD
	PINA Tais	POR
	SAMARDZIC Aleksandra	BIH
	KHRAMOIKINA Daria	AIN

1	BUTKEREIT M. (GER)	33	TOKAREVA E. (KAZ)
2	TOKAREVA E. (KAZ)	00 s0 / 00 s0 [00:00]	
3	POLLING K. (NED)	49	POLLING K. (NED)
4	ESPOSITO M. (ITA)	34	POLLING K. (NED)
5	MATNIYAZOVA G. (UZB)	11 s2 / 00 s3 [01:56]	
6	PINA T. (POR)	35	PINA T. (POR)
7	SAMARDZIC A. (BIH)	50	PINA T. (POR)
8	KHRAMOIKINA D. (AIN)	36	SAMARDZIC A. (BIH)
			10 s0 / 00 s0 [00:28]

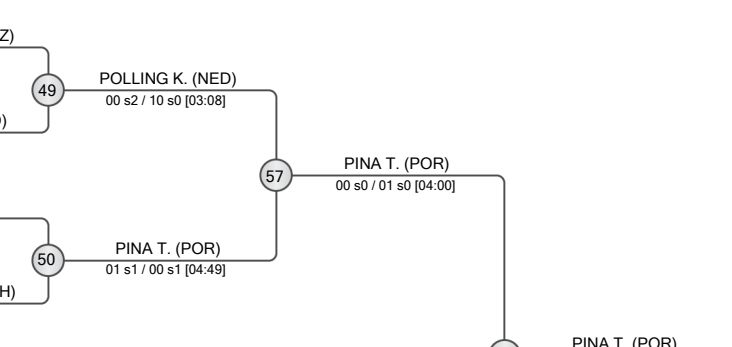

POOL B

	COUGHLAN Aoife	AUS
	SOOK Emilie	DEN
	POGACNIK Anka	SLO
	ERIKSSON Ida	SWE
	MYERS Melissa	USA
	RODRIGUEZ Elvismar	VEN
	PILECKAITE Ugne	LTU
	YEATS-BROWN Katie-Jemima	GBR
	KORKMAZ Sila	TUR
	CARVALHO Luana	BRA

9	COUGHLAN A. (AUS)	37	COUGHLAN A. (AUS)
10	SOOK E. (DEN)	51	COUGHLAN A. (AUS)
11	POGACNIK A. (SLO)	01 s2 / 00 s2 [04:00]	
12	MYERS M. (USA)	38	POGACNIK A. (SLO)
13	RODRIGUEZ E. (VEN)	39	RODRIGUEZ E. (VEN)
14	YEATS-BROWN K. (GBR)	52	RODRIGUEZ E. (VEN)
15	KORKMAZ S. (TUR)	40	CARVALHO L. (BRA)
16	CARVALHO L. (BRA)	40	CARVALHO L. (BRA)
			00 s1 / 10 s1 [01:12]

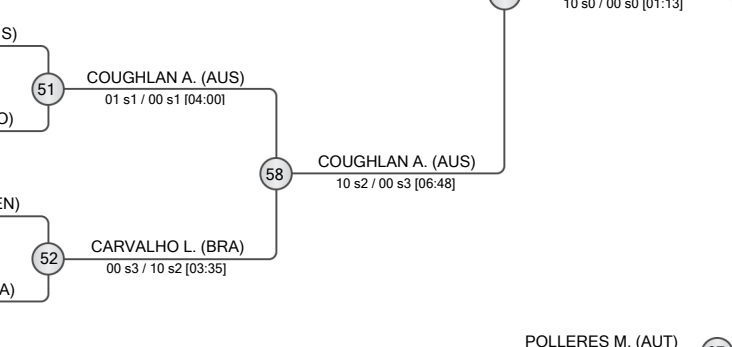

POOL C

	POLLERES Michaela	AUT
	OLSEN Laerke	DEN
	YU Hyeonji	KOR
	NAZAROVA Shokhista	UZB
	GERCSAK Szabina	HUN
	DRYSDALE DALEY Ebony	JAM
	SCOCCIMARRO Giovanna	GER
	PEDROTTI Irene	ITA
	CARDOSO Kaillany	BRA
	BATSUURI Nyam-Erdene	MGL
	KOWALEWSKA Aleksandra	POL

17	POLLERES M. (AUT)	41	POLLERES M. (AUT)
18	YU H. (KOR)	53	POLLERES M. (AUT)
19	GERCSAK S. (HUN)	42	GERCSAK S. (HUN)
20	DRYSDALE DALEY E. (JAM)	42	GERCSAK S. (HUN)
21	SCOCCIMARRO G. (GER)	43	SCOCCIMARRO G. (GER)
22	PEDROTTI I. (ITA)	54	SCOCCIMARRO G. (GER)
23	BATSUURI N. (MGL)	44	BATSUURI N. (MGL)
24	KOWALEWSKA A. (POL)	44	BATSUURI N. (MGL)
			00 s0 / 11 s1 [01:53]
			10 s0 / 00 s0 [00:30]

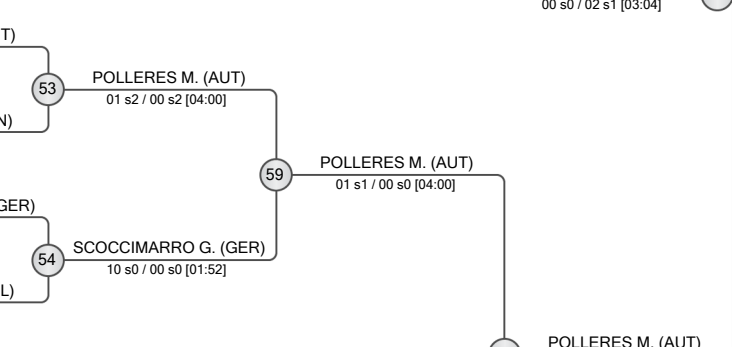

POOL D

	TSUNODA ROUSTANT Ai	ESP
	JAGER Hilde	NED
	TAKAYAWA Shanice	FIJ
	CRISOSTOMO Joana	POR
	PETERSEN POLLARD Kelly	GBR
	TAIMAZOVA Madina	AIN
	NIANG Assmaa	MAR
	LIAO Yu-Jung	TPE
	GULBANI Nino	GEO
	HAWKES Rachael	IRL

25	TSUNODA ROUSTANT A. (ESP)	45	TSUNODA ROUSTANT A. (ESP)
26	JAGER H. (NED)	55	TSUNODA ROUSTANT A. (ESP)
27	CRISOSTOMO J. (POR)	46	CRISOSTOMO J. (POR)
28	PETERSEN POLLARD K. (GBR)	46	CRISOSTOMO J. (POR)
29	TAIMAZOVA M. (AIN)	47	TAIMAZOVA M. (AIN)
30	NIANG A. (MAR)	56	TAIMAZOVA M. (AIN)
31	GULBANI N. (GEO)	48	GULBANI N. (GEO)
32	HAWKES R. (IRL)	48	GULBANI N. (GEO)
			00 s1 / 01 s2 [04:00]
			02 s2 / 00 s0 [03:34]

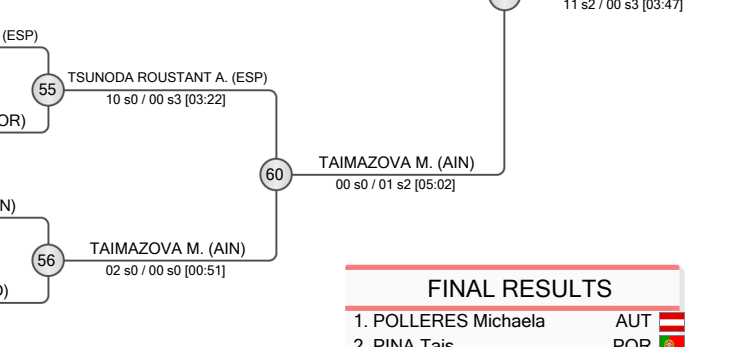

REPECHAGE

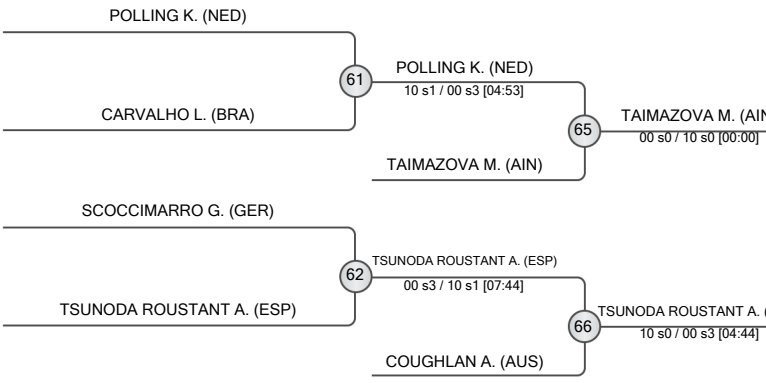

### FINAL RESULTS

1. POLLERES Michaela AUT
2. PINA Tais POR
3. TAIMAZOVA Madina AIN
3. TSUNODA ROUSTANT Ai ESP
5. POLLING Kim NED
5. COUGHLAN Aoife AUS
7. CARVALHO Luana BRA
7. SCOCCIMARRO Giovanna GER





# Antalya Grand Slam 2024

Türkiye, Antalya, 29-31 Mar 2024

## -78 kg

Women (31)

POOL A

	WAGNER Anna-Maria	GER
	YATIM Hafsa	MAR
	FIGUEROA Camila	PER
	REID Emma	GBR
	MICHAELIDOU Zanet	CYP
	OTGONBAYAR Khuslen	MGL
	DOLGILEVICA Una	LAT

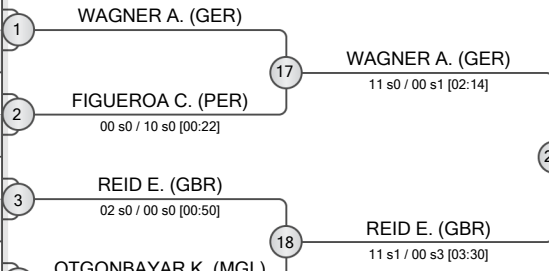

POOL B

	SAMPAIO Patricia	POR
	CVIJIC Milica	SRB
	PAVIC Petrunjela	CRO
	JANGELDINA Aruna	KAZ
	MALONGA Madeleine	FRA
	DUDENAITE Migle Julija	LTU
	SHMELEVA Antonina	AIN
	KURBANBAEVA Iriskhon	UZB

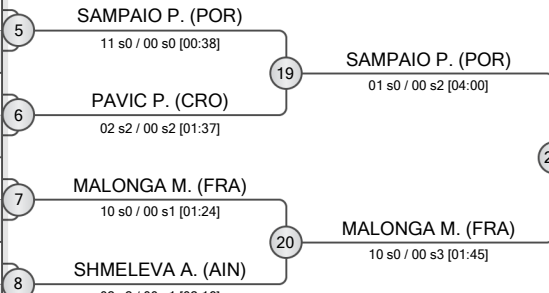

POOL C

	BOEHM Alina	GER
	KANTSAVAYA Darya	AIN
	GRITSENKO Margarita	KAZ
	POWELL Natalie	GBR
	STANGHERLIN Giorgia	ITA
	VAN HEEMST Yael	NED
	CARDONA Lianet	CUB
	HSU WANG Shu Huei	TPE

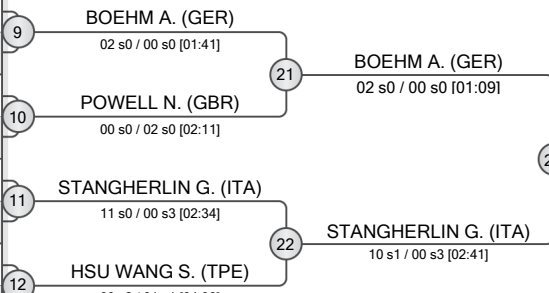

POOL D

	MA Zhenzhao	CHN
	BATBAYAR Erdenet-Od	MGL
	BRANSER Marie	GUI
	DAHARLI Serdem	TUR
	LOBNIK Metka	SLO
	PACUT-KLOCZKO Beata	POL
	TATARCHENKO Nadezhda	AIN
	PRODAN Karla	CRO

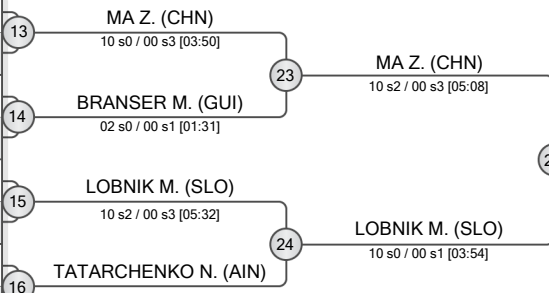

REPECHAGE

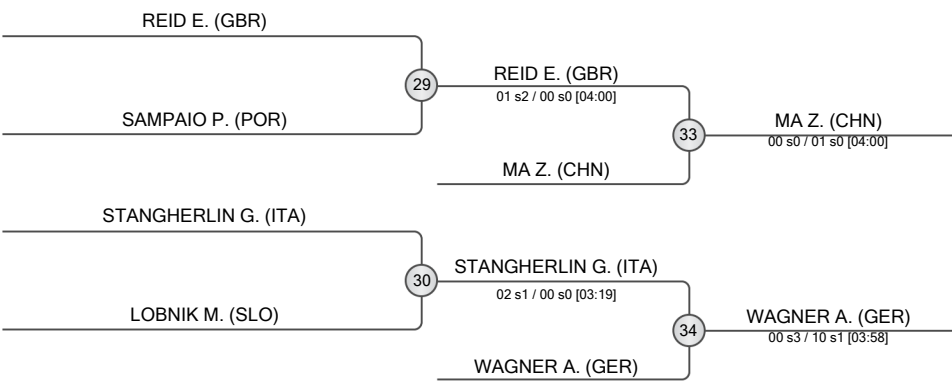

FINAL RESULTS	
1.	MALONGA Madeleine
2.	BOEHM Alina
3.	MA Zhenzhao
3.	WAGNER Anna-Maria
5.	REID Emma
5.	STANGHERLIN Giorgia
7.	SAMPAIO Patricia
7.	LOBNIK Metka





# Antalya Grand Slam 2024

Türkiye, Antalya, 29-31 Mar 2024

## + 78 kg

Women (34)

POOL A

1	XU Shiyan (CHN)	XU S. (CHN)
2	HOELLWART Maria (AUT)	HOELLWART M. (AUT)
3	CERIC Larisa (BIH)	CERIC L. (BIH)
4	HOMAN Khrystyna (UKR)	HOMAN K. (UKR)
5	OZTURK Hilal (TUR)	OZTURK H. (TUR)
6	VLADIMIROVA Daria (AIN)	VLADIMIROVA D. (AIN)
7	VUKOVIC Helena (CRO)	VUKOVIC H. (CRO)
8	LEE Hyeonji (KOR)	LEE H. (KOR)
	RAMAZANOVA Akerke (KAZ)	RAMAZANOVA A. (KAZ)

POOL B

9	SU Xin (CHN)	SU X. (CHN)
10	URDANETA Amarantha (VEN)	URDANETA A. (VEN)
11	AMARSAIKHAN Adiyasuren (MGL)	AMARSAIKHAN A. (MGL)
12	PORTUONDO ISASI Ana Laura (CAN)	PORTUONDO ISASI A. (CAN)
13	OZDEMIR Kayra (TUR)	OZDEMIR K. (TUR)
14	BOUIZGARNE Samira (GER)	BOUIZGARNE S. (GER)
15	HOFMAN Urszula (POL)	HOFMAN U. (POL)
16	SOMKHISHVILI Sophio (GEO)	SOMKHISHVILI S. (GEO)

POOL C

17	KIM Hayun (KOR)	KIM H. (KOR)
18	SUTALO Ivana (CRO)	SUTALO I. (CRO)
19	LUCHT Renee (GER)	LUCHT R. (GER)
20	TAVANO Asya (ITA)	TAVANO A. (ITA)
21	ZABIC Milica (SRB)	ZABIC M. (SRB)
22	ESIR Kubranur (TUR)	ESIR K. (TUR)
23	DAMBADARJAA Nominzul (MGL)	DAMBADARJAA N. (MGL)
24	ALQAHTANI Tahani (KSA)	ALQAHTANI T. (KSA)
	DIACENCO Oxana (MDA)	DIACENCO O. (MDA)

POOL D

25	FONTAINE Lea (FRA)	FONTAINE L. (FRA)
26	ORTIZ Idalys (CUB)	ORTIZ I. (CUB)
27	ILMATOVA Rinata (UZB)	ILMATOVA R. (UZB)
28	PARAGULGOVA Madina (KAZ)	PARAGULGOVA M. (KAZ)
29	TOLOFUA Julia (FRA)	TOLOFUA J. (FRA)
30	WOOD Gabriella (TTO)	WOOD G. (TTO)
31	MORILLO Moira (DOM)	MORILLO M. (DOM)
32	SERTEL Ipek (TUR)	SERTEL I. (TUR)

REPECHAGE

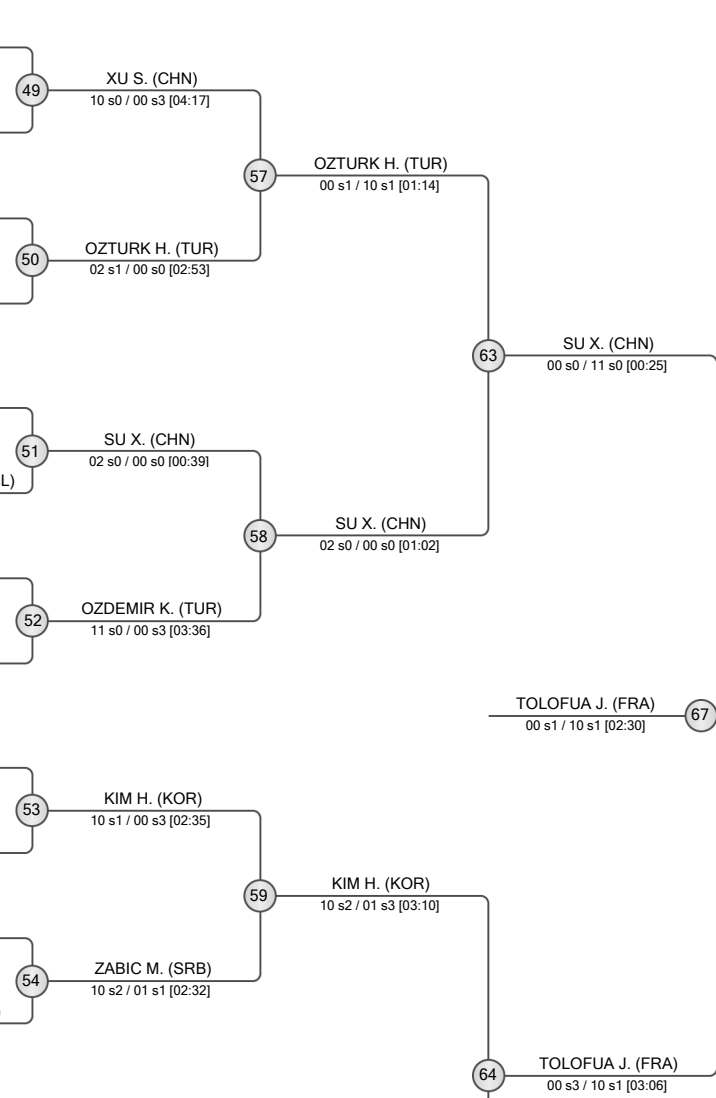
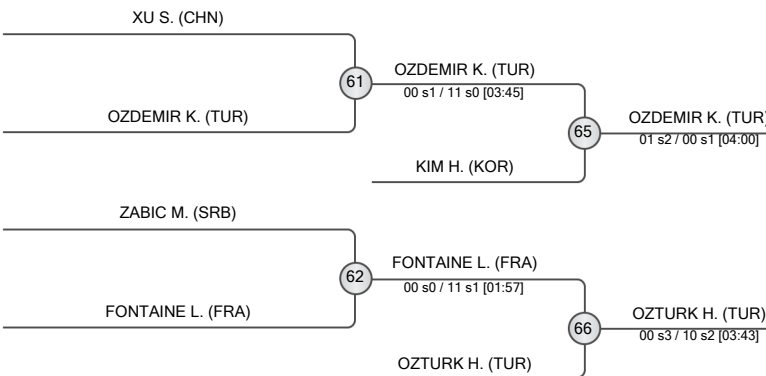

FINAL RESULTS		
1.	TOLOFUA Julia	FRA
2.	SU Xin	CHN
3.	OZDEMIR Kayra	TUR
3.	OZTURK Hilal	TUR
5.	KIM Hayun	KOR
5.	FONTAINE Lea	FRA
7.	XU Shiyan	CHN
7.	ZABIC Milica	SRB

