

INTERNATIONAL JUDO FEDERATION



DOCUMENT

SOR

Sport and Organisation Rules



Version: 23 July 2019

TABLE OF CONTENTS

GENERAL INFORMATION	6
1.1 Preamble and Basic Principles.....	7
1.2 Clean Judo	7
1.2.1 Disciplinary Commission	7
1.2.2 Match Fixing and Competition Manipulation.....	8
1.2.3 Policy for Safeguarding Athletes and Other Participants from Harassment and Abuse	9
1.3 Insurance and Civil Liability	10
1.4 Gender Control.....	10
1.5 Minor Athletes.....	11
1.6 IJF Calendar	11
1.7 Nationality.....	12
1.7.1 Change of Nationality	12
1.7.1.1 Change of Nationality for a period of less than three years	12
1.7.1.2 Change of Nationality after a period of three years or longer	13
1.7.2 Special Circumstances	13
1.7.2.1. Athletes with an official refugee status	13
1.7.2.2 Junior and younger immigrants	14
1.8 Weight Categories for Individual Competitions.....	15
1.9 Weight Categories for Mixed Team Competitions.....	16
1.10 Weight Categories for Team Competitions.....	17
1.11 Age Groups	17
1.12 Time Duration of Contests.....	18
1.13 Event Outlines	19
1.13.1 Visas.....	19
1.13.2 Transportation	19
1.13.3 Accommodation.....	19
1.13.4 Training.....	20
1.13.5 Insurance.....	20
1.13.6 Consent for photography/videos/filming	20
1.14 Official Notice Boards.....	20
 COMPETITION SCHEDULES AND SYSTEMS	 22
2.1 Competition Format and Schedules for the IJF World Judo Tour	23
2.2 Competition Systems.....	24
2.2.1 Direct Knockout.....	24
2.2.2 Quarter-final Repechage	24
2.2.3 Double Repechage.....	24
2.2.4 Full Repechage	24
2.2.5 Round Robin.....	24
2.3 Regulations for Low Numbers of Athletes or Teams	25
2.3.1 Low Numbers Rules for IJF World Ranking List Individual and Mixed Team Events.....	25
2.3.2 Low Numbers Rules for Other Individual and Team Events.....	26
2.4 Competition System for Mixed Team and Team Events	28
2.4.1 Regulations for Mixed Team Events.....	28
2.4.2 Regulations for Female and Male Team Events	29



WORLD RANKING LIST AND IJF RANKING EVENTS	32
3.1 IJF Senior World Ranking List	33
3.2 IJF Mixed Teams World Ranking List	35
3.3 Nation World Ranking List	36
3.4 IJF Junior and Cadet World Ranking Lists	36
3.5 Additional Rules	37
ENTRIES AND ACCREDITATION	38
4.1 Entries for IJF WJT Events	39
4.2 Cancellation of Athletes	40
4.3 Number of Entries	40
4.4 Accreditation	42
DRAW	44
5.1 Draw Regulations	45
5.2 Seeding for IJF WJT Events	45
WEIGH-IN AND JUDOJI BACKNUMBER CONTROL	48
6.1 Location of the Weigh-in and Judogi Backnumber Control	49
6.2 Weigh-in Rules	49
6.2.1 Individual Events Weigh-In	49
6.2.2 Female and Male Teams and Mixed Teams Weigh-in	49
6.3 Official Weigh-in Procedure	50
6.3.1 Failure to Appear for the Weigh-in	50
6.3.2 Failure to Weigh-in Within the Prescribed Limits of a Category	51
6.3.3 Failure to Comply with Official Directions or with the Requirements of the IJF SOR	51
6.3.4 After Weigh-in Procedure	51
6.4 Random Weigh-In	51
6.4.1 Draw of the Athletes (individual events)	51
6.4.2 Collecting the Athletes	51
6.4.3 Weigh-in Procedure	52
6.4.4 After Weigh-in Procedure	52
EDUCATION AND COACHING	54
7.1 Coaches' Code of Conduct	55
7.2 Coaches' Dress Code	55
7.3 Contest Review Process	55
COMPETITION VENUE	56
8.1 Venue	57
8.2 Training Venue	57
8.3 Warm Up Area and Judogi Control	57
8.4 Athlete Seating and Facilities	58
8.5 Entry to and Exit from Field of Play	58
8.6 Field of Play and Competition Area	59
8.7 Officials	60
8.8 Medical	60
8.9 Media	60
8.10 Awarding Ceremonies	60
8.11 Delay, Postponement or Cancellation of a Competition	61



REGULATIONS FOR VETERANS	62
REGULATIONS FOR KATA	68
IJF JUDOGI RULES	72
IJF REFEREEING RULES	88
IJF MEDICAL AND ANTI-DOPING HANDBOOK	138
IJF DISCIPLINARY CODE AND CODE OF ETHICS	144
SPORT COMPETITION	154
GLOSSARY	186

Abbreviations

EOG - Event Organisation Guide

IOC - International Olympic Committee

SOR - Sport and Organisation Rules

WRL - World Ranking List

IJF - International Judo Federation

NOC - National Olympic Committee

WJT- World Judo Tour

In the International Judo Federation (IJF) Sport and Organisation Rules (SOR) the masculine gender is used to refer to any physical person, (i.e. member, leader, team official, participant, athlete, coach, judge, referee or chaperone etc.) and it shall, unless there is a specific provision to the contrary, be understood to include the feminine gender.

The latest version of the SOR can be downloaded at www.ijf.org.

The original language of this document is English except for Appendix C, which has been translated from French.





GENERAL INFORMATION

SECTION 1

1.1 Preamble and Basic Principles

The Sport and Organisation Rules (SOR) of the International Judo Federation (IJF) in conjunction with the statutes, finance rules, contract with the relevant National Judo Federation (hereafter referred to as National Federation) and the IJF Event Organisation Guide (EOG), are the binding documents for the holding of the events on the IJF World Judo Tour (WJT). For all events on the WJT the IJF has final appellate jurisdiction.

Specific supplemental procedures will be issued for the holding of judo competitions at the Summer Olympic and Youth Olympic Games.

The IJF Executive Committee shall allocate events to host Organising Committees. The organisation of any World Championships is the concern of the following bodies: the IJF, the Continental Union to which the Organising National Federation belongs and the National Federation, which has been commissioned by the IJF Executive Committee to be the host. The Continental Union is consulted in any questions and supports both the IJF and the National Federation. The National Federation must name an Organising Committee to deal with the organisation of the event.

The IJF shall accept control over regional judo competitions whenever this is so directed by the Executive Committee or the IJF Congress. This requires adherence to the above rules and documents. In such judo competitions refereeing and technical organisation shall be dealt with by the Continental Union or regional body and supervised by the officials nominated by the IJF.

The IJF Veterans Commission is responsible for all IJF veteran activities (Appendix A). The IJF Kata Commission is responsible for all IJF kata activities (Appendix B).

1.2 Clean Judo

Integrity, discipline and ethics are core principles in judo, both on and off the field of play, refer to Appendix F for the IJF Disciplinary Code and IJF Code of Ethics.

Further information on the International Olympic Committee (IOC) Code of Ethics can be found in this document “Olympic Movement Code on the Prevention of the Manipulation of Competitions”.

<https://stillmed.olympic.org/media/Document%20Library/OlympicOrg/IOC/What-We-Do/Protecting-Clean-Athletes/Competition-manipulation/Code-Prevention-Manipulation-Competitions.pdf>

1.2.1 Disciplinary Commission

The IJF Executive Committee has the authority to establish a Disciplinary Commission to evaluate presumed violation of the IJF rules and it reserves the right to take disciplinary measures in the case of cheating, misconduct and any behaviour contrary to the ethics and moral values of sport, particularly judo, and any violation of the IJF SOR.

The IJF Disciplinary Commission will take sanctions in compliance with the IJF Disciplinary Code (Appendix F). If during an IJF event, starting from the arrival (normally airport or train station) at the event and until the departure from the event, there is an incident an immediate decision to suspend anyone involved

may be taken on the spot. This decision will be placed under the responsibility of an Executive Committee member, nominated before each event by the IJF President, who will form an Ad Hoc Commission to deal with the issue. The Ad Hoc Commission will consist of IJF Executive Committee members or their representatives.

Any incident will be communicated immediately to the IJF President, IJF Executive Committee members and the IJF Disciplinary Commission. A possible sanction decision will be taken after having heard the person/people concerned and any potential witness(es). If the concerned person is a minor, an adult responsible for the delegation will accompany them, during the discussion. As soon as the decision is taken, the Ad Hoc Commission will immediately inform the IJF President, the IJF Executive Committee and the IJF Disciplinary Commission about its decision.

A report of the incident and final decision should be sent to the Disciplinary Commission, c/o the IJF General Secretariat, within three days of the date of the incident. The report will be written by the Education and Coaching Commission and must state the following: the facts, including the recall of the alleged facts, a summary of the observations and arguments of the parties, the grounds for the decision and any other comments.

The IJF Disciplinary Commission, upon receipt of the documents, will inform those involved about its decision 15 days after the date of the incident. The IJF Disciplinary Commission will decide the start date and the duration of the suspension.

If an individual disagrees with a decision, a written appeal may be submitted to the IJF Disciplinary Commission, c/o the IJF General Secretariat, within one calendar month from the incident date. In the case of suspension, the decision will stand until the outcome of the appeal is heard.

Any situation that is not covered by the IJF SOR shall be dealt with by the IJF Executive Committee.

1.2.2 Match Fixing and Competition Manipulation

The integrity of sport depends on the outcome of sporting events and competitions being based entirely on the merits of the participants involved. Any form of corruption that might undermine public confidence in the integrity of a judo contest is fundamentally contrary to the spirit of sport and subject to severe sanctions.

The IJF has Rules dedicated to Sports Integrity in relation to betting.

There are four core rules to remember:

- Always do your best, never fix a contest.
- Never bet on your competition, never bet on your sport.
- Never share information that could be used for betting purposes, or any form of manipulation of sports competitions or any other corrupt purposes whether by the participant or via another person and/or entity.
- If you are approached to cheat, speak out!

Competition manipulation is defined as an intentional arrangement, act or omission aimed at an improper alteration of the result or the course of a sports competition in order to remove all or part of the unpredictable nature of the sports competition with a view to obtaining an undue benefit for oneself or for other. If a contest takes place and seems to have been played to a predetermined result, violating the IJF rules, further investigation may be undertaken and any findings of match fixing will result in disciplinary action.

If in IJF events (individual or team), an athlete is injured or ill before a contest and needs to withdraw they must have a medical certificate from the IJF Medical Commissioner.

The IJF may undertake further investigation and any findings of match fixing will result in disciplinary action. The result of the contest will be cancelled if any athlete is caught not telling the truth.

Match fixing and competition manipulation can be reported, anonymously and confidentially, here: <https://reportintegrity.judobase.org/form>. Any report made in good faith will not be sanctioned. Any form of retaliation against whistle-blowers is prohibited and such action will be sanctioned.

Failure to report to the IJF at the first available opportunity any information about betting, match fixing or competition manipulation including that could amount to a violation of the SOR.

The following conducts constitute a violation of the SOR:

- Failing to cooperate with any investigation carried out by the IJF in relation to a possible breach of this regulation, including, without limitation, failing to provide accurately, completely and without undue delay any information and/or documentation and/or access or assistance requested by the IJF as part of such investigation.
- Obstructing or delaying any investigation that may be carried out by the IJF in relation to a possible violation of this regulation, including without limitation concealing, tampering with or destroying any documentation or other information that may be relevant to the investigation.

1.2.3 Policy for Safeguarding Athletes and Other Participants from Harassment and Abuse

This policy applies to all persons affiliated with the IJF including athletes.

“Harassment” or “harassment and abuse” includes physical or psychological abuse and sexual abuse (which can be a form of physical and/or psychological abuse).

“Physical or psychological abuse” means any improper and unwelcome conduct that might reasonably be expected or be perceived to cause offence, harm or humiliation to another.

“Sexual abuse” means any unwanted, groomed or forced involvement in sexual behaviour, unwelcome verbal or physical conduct or gesture of a sexual nature (e.g. the use of offensive stereotypes based on gender, sexual jokes, threats, intimidation) that might reasonably be expected or be perceived to cause offence or humiliation to another.

Harassment can be based on any grounds such as race, religion, colour, creed, ethnic origin, physical attributes, gender or sexual orientation. It can include a one-off incident or a series of incidents. It may be in person or online. Harassment may be deliberate, unsolicited and coercive. Harassment and abuse often results from an abuse of authority, meaning the improper use of a position of influence, power or authority by an individual against another person.

Cases of harassment and abuse can be reported on the Clean Judo platform and will be investigated by the IJF Disciplinary Commission in compliance with the IJF Disciplinary Code (Appendix F).

Any alleged incidents of harassment and abuse will be regarded as confidential and personal information (including in particular name, date of birth, address, identification numbers) will not be disclosed, except, for example, if the concerned person gives his prior consent, if disclosure is necessary to protect someone from harm or if a potential criminal act comes to the attention of the IJF.

Harassment and abuse can be reported, anonymously and confidentially, here: <https://reportintegrity.judobase.org/form>

1.3 Insurance and Civil Liability

Each National Federation is directly responsible for its athletes (including the control of non-pregnancy). It must assume all responsibility for accident and health insurance as well as civil liabilities during all IJF events for everyone under their charge.

National Federations are also responsible to ensure that athletes who participate in the IJF WJT have sufficient technical knowledge (know the terminology and can execute all the techniques in Appendix H) and understand fully the IJF sport and refereeing rules.

1.4 Gender Control

Control of an athlete's gender is the responsibility of the National Federation. The IJF will apply the current IOC recommendation. Any decisions of a member National Federation concerning an athlete's gender must be communicated immediately to the IJF President.

Any official complaint by a National Federation, a Continental Union or a member of the IJF Executive Committee concerning an athlete's gender must be sent to the IJF President. On the basis of the official complaint, the IJF Executive Committee will decide if it is necessary to follow up on this complaint and to bring it before the Gender Control Commission. The IJF Executive Committee can also call out to the member National Federation of the athlete concerned so that they decide on the gender of the athlete concerned.

The Gender Control Commission is composed of a doctor competent in the field of gender reassignment, a jurist and a member of the IJF Executive Committee appointed by the IJF President. This commission will be able to call on experts recognised in this field.

All decisions made by a member National Federation about an athlete's gender must be submitted exclusively by the athlete concerned to the IJF Gender Control Commission in the case of a contestation.

The IJF Gender Control Commission will have the full authority to ask all those concerned for any documents or information necessary for the hearing of the case which has been referred. The Gender Control Commission will establish an internal regulation to define the progress of the procedure that must guarantee confidentiality of the procedure and respect data protection and the private lives of those concerned.

The decision of the IJF Executive Committee not to follow up on an official complaint as well as the decisions of the Gender Control Commission can be submitted exclusively by way of appeal to the Court of Arbitration for Sport in Lausanne, Switzerland, that will definitely decide on litigation according to the code of arbitration concerning sport. The delay of appeal is twenty-one days from receipt of the decision being the subject of the appeal. The panel will be composed of only one judge. The language of the arbitration will be English.

1.5 Minor Athletes

The National Federation is responsible for obtaining legal approval and permission for minor athletes to compete in competitions. When travelling with minors the team official/coach must have all the necessary documents in place that authorises them to act on behalf of the parents/guardians "in loco parentis".

This also applies to doping testing. The National Federation must ensure that minor athletes have their parental/guardian permission to undergo testing (see Appendix E1.4.3.1).

1.6 IJF Calendar

World Championships Seniors and Mixed Teams will be conducted each year at a time similar to that of the Olympic Summer Olympic Games with exception of the year in which the Olympic Games are held.

World Championships Open is held in accordance with a schedule approved by the IJF Executive Committee.

World Championships Juniors and Mixed Teams will take place each year except the year with the Summer Olympic Games.

World Championships Cadets and Mixed Teams will take place in accordance with a schedule approved by the IJF Executive Committee.

Summer Olympic Games and Summer Youth Olympic Games are held every four years in accordance with a schedule approved by the IOC.

The current IJF calendars can be found on the IJF website (<http://ijf.org>).

1.7 Nationality

The athletes must be of the same nationality as the National Federation for which they have been entered for the competition. Persons appointed by the Executive Committee of the IJF shall verify the citizenship of the athletes. The evidence of citizenship shall be the production of a **valid** passport issued by the represented country.

In the following cases, procedures must be applied:

a) Where the competitions are being held in a country in which the residents do not hold passports while in that country.

b) Where there is a possible problem of “joint citizenship”, e.g. Puerto Rico an acceptable substitute for the passport will be a letter or certificate from the athlete’s National Olympic Committee (NOC) or, if there is no such body, from the National Sports Authority confirming the athlete’s residence in that country and the citizenship.

If a competitor has multiple citizenships, they may compete for only one country.

1.7.1 Change of Nationality

A competitor who has represented one country in:

- Olympic Games
- World Championships (senior, junior, cadet)
- Continental Championships (senior, junior, cadet)
- Regional Games and Multi-Sport Games (such as Pan American Games, African Games, European Games, Commonwealth Games, Mediterranean Games, Francophone Games, Youth Olympic Games)
- International Tournaments organised by the IJF (Grand Prix, Grand Slam, Masters) or under its auspices (continental open and cups),
- All competitions in the IJF calendar except veterans, kata, military*

and who has changed his nationality or acquired a new nationality may represent his new country provided that at least three years have passed since the athlete last represented his former country.

*Veterans, military and kata participants are excluded from this rule and can change without waiting the three-year period.

If the two National Federations (current country and new country) concerned agree, they may request the IJF to shorten the period of three years or even to cancel the duration completely (see Olympic Charter, Rule 41 and the Bye-law to Rule 41). Thus, the IJF can’t shorten the three years’ period without written agreement from both National Federations concerned and the athlete having a valid passport for the new country.

1.7.1.1 Change of Nationality for a period of less than three years

An athlete cannot represent a new National Federation without the approval of the IJF.

The request to shorten the three-year period shall be sent via email to the IJF General Secretariat (gs@ijf.org) and must include the following documents:

Letter from the President of the National Federation (the current country) certifying the absence of objection to the change of the nationality of the concerned athlete. Letter from the President of the National Federation (the new country) authorising the athlete to represent them in international competitions.

- Letter from the athlete, who has already represented one country, giving evidence of their wish to represent their new National Federation.
- A copy of the athlete passport proving the nationality of the new country.

On receipt of a complete file the IJF General Secretary will examine it and send it out to the IJF Executive Committee for approval. If the majority of the IJF Executive Committee approves the request, the IJF General Secretary confirms the acceptance of the application to the concerned party, with both the current and new National Federations in copy. Any athlete disrespecting this rule may be subject to disciplinary measures.

1.7.1.2 Change of Nationality after a period of three years or longer

An athlete cannot represent a new National Federation without informing the IJF even if three years or longer have passed since the athlete competed for their previous National Federation.

The IJF must be informed officially by the new National Federation via email to both the IJF General Secretariat - gs@ijf.org and Registration Management - registration@ijf.org. This must be done also for veterans, military and kata participants.

The information must include the following documents:

- Letter from the President of the new National Federation (the new country) authorising the athlete to represent them in international competitions.
- Letter from the athlete, who has represented one country, giving evidence of their wish to represent their new National Federation.
- A copy of the athlete passport proving the nationality of the new country.

On receipt of a complete file the IJF General Secretary will examine it and send it out to the IJF Executive Committee for information. Any athlete disrespecting this rule may be subject to disciplinary measures.

1.7.2 Special Circumstances

For events organised by the IJF or under its auspices, the IJF Executive Committee, in order to protect the interest of the athlete, can authorise that the athlete can compete under the IJF flag for any reason (for example: non-official refugee status of the athlete, non-recognition of the NOC by the IOC, suspension of the National Federation etc.).

1.7.2.1. Athletes with an official refugee status

Judoka with an official refugee status, hosted by a country, can qualify themselves for IJF or continental union competitions through their host country national championships and **consequently they will compete internationally** under their host country flag. The National federation requests must be sent, with the official refugee status **documents**, to the IJF General Secretariat (gs@ijf.org). If the documents sent are compliant, the agreement will be automatically given by the IJF General Secretary following confirmation by the IJF President.

If there is a change in the status of the official refugee i.e. citizenship of a new country, return to their country of origin etc.
The nationality change process must be followed.

For events organised by the IJF or under its auspices, the IJF Executive Committee can authorise that judoka with an official refugee status can compete under the IJF flag.

If there is a change in the status of the official refugee who competed under the IJF flag i.e. citizenship of a new country, return to their country of origin etc. the IJF Executive Committee would make a decision concerning the change of nationality and the world ranking points that the athlete has.

All documents relating to the new status and change request must be submitted to the IJF General Secretariat at gs@ijf.org, within a deadline of at least 15 days prior to the closing date of registration for a certain event.

1.7.2.2 Junior and younger immigrants

Juniors (men and women under 21, age 15 to 20 years in the calendar year) and younger foreign judoka living in a host country can participate in their host country national Juniors and younger championships and thus qualify themselves for IJF or Continental Union Juniors and younger competitions. They can be registered, by the national federation of the host country, into IJF or Continental Unions Juniors and younger competitions if they meet the following requirements:

- To prove their residency in the host country (at least 1 year).
- To prove the integration of their parents in the host country (at least 1 year).
- To prove their integration in the school or university system (at least 1 year).
- To prove their integration in a judo club of the host country, duly affiliated to the National Federation which is an IJF member.

If the National Federations of host countries wish to register these athletes, they must send their request each year to the IJF General Secretariat (gs@ijf.org), with the above-mentioned documents. Additionally, the National Federations shall also attach the agreement of the judoka and the authorisation of the parents/guardians, if minor.

The IJF will review the submitted documents and if deemed compliant, The IJF will approve the request and the General Secretary will send a certificate for the registration in Judobase.

In case of approval, the concerned judoka will compete under their host country flag.

Should the athlete wish to return to his country of origin, or should he change residence to another host country, he is free to do so and take any ranking points with him, upon submission of the documents proving the relocation to the IJF General Secretariat at gs@ijf.org. No change of nationality process required.

1.8 Weight Categories for Individual Competitions

The following weight categories will be utilised in the World Championships and competitions held under the auspices of the IJF.

Senior and Junior Women	-48 kg	Extra-lightweight	up to and including 48 kg
	-52 kg	Half-lightweight	over 48 kg up to and including 52 kg
	-57 kg	Lightweight	over 52 kg up to and including 57 kg
	-63 kg	Half-middleweight	over 57 kg up to and including 63 kg
	-70 kg	Middleweight	over 63 kg up to and including 70 kg
	-78 kg	Half-heavyweight	over 70 kg up to and including 78 kg
	+78 kg	Heavyweight	over 78 kg
	Open	Open-weight	no weight limit
Cadet Women under 18 years	-40 kg	Featherweight	up to and including 40 kg
	-44 kg	Extra-lightweight	over 40 kg up to and including 44 kg
	-48 kg	Half-lightweight	over 44 kg up to and including 48 kg
	-52 kg	Lightweight	over 48 kg up to and including 52 kg
	-57 kg	Half-middleweight	over 52 kg up to and including 57 kg
	-63 kg	Middleweight	over 57 kg up to and including 63 kg
	-70 kg	Half-heavyweight	over 63 kg up to and including 70 kg
	+70 kg	Heavyweight	over 70 kg
Senior and Junior Men	-60 kg	Extra-lightweight	up to and including 60 kg
	-66 kg	Half-lightweight	over 60 kg up to and including 66 kg
	-73 kg	Lightweight	over 66 kg up to and including 73 kg
	-81 kg	Half-middleweight	over 73 kg up to and including 81 kg
	-90 kg	Middleweight	over 81 kg up to and including 90 kg
	-100 kg	Half-heavyweight	over 90 kg up to and including 100 kg
	+100 kg	Heavyweight	over 100 kg
	Open	Open-weight	no weight limit
Cadet Men under 18 years	-50 kg	Featherweight	up to and including 50 kg
	-55 kg	Extra-lightweight	over 50 kg up to and including 55 kg
	-60 kg	Half-lightweight	over 55 kg up to and including 60 kg
	-66 kg	Lightweight	over 60 kg up to and including 66 kg
	-73 kg	Half-middleweight	over 66 kg up to and including 73 kg
	-81 kg	Middleweight	over 73 kg up to and including 81 kg
	-90 kg	Half-heavyweight	over 81 kg up to and including 90 kg
	+90 kg	Heavyweight	over 90 kg



1.9 Weight Categories for Mixed Team Competitions

Senior and Junior Mixed	-57 kg	Women	up to and including 57 kg
	-73 kg	Men	up to and including 73 kg
	-70 kg	Women	over 57 kg up to and including 70 kg
	-90 kg	Men	over 73 kg up to and including 90 kg
	+70 kg	Women	over 70 kg
	+90 kg	Men	over 90 kg
Senior Mixed Olympic Games	-57 kg	Women (48 kg, 52 kg, 57 kg*)	up to and including 57 kg
	-73 kg	Men (60 kg, 66 kg, 73 kg*)	up to and including 73 kg
	-70 kg	Women (57 kg, 63 kg, 70 kg*)	up to and including 70 kg
	-90 kg	Men (73 kg, 81 kg, 90 kg*)	up to and including 90 kg
	+70 kg	Women (70 kg, 78 kg, +78 kg*)	over 70 kg
	+90 kg	Men (90 kg, 100 kg, +100 kg*)	over 90 kg
Cadet Mixed	-48 kg	Women	up to and including 48 kg
	-60 kg	Men	up to and including 60 kg
	-63 kg	Women	over 48 kg up to and including 63 kg
	-81 kg	Men	over 60 kg up to and including 81 kg
	+63 kg	Women	over 63 kg
	+81 kg	Men	over 81 kg

*Athletes qualified only in these individual categories can take part in the mixed team category.

1.10 Weight Categories for Team Competitions

Senior and Junior Women	-52 kg	Half-lightweight	up to and including 52 kg
	-57 kg	Lightweight	over 52 kg up to and including 57 kg
	-63 kg	Half-middleweight	over 57 kg up to and including 63 kg
	-70 kg	Middleweight	over 63 kg up to and including 70 kg
	+70 kg	Half-heavyweight	over 70 kg
Cadet Women	-48 kg	Half-lightweight	up to and including 48 kg
	-52 kg	Lightweight	over 48 kg up to and including 52 kg
	-57 kg	Half-middleweight	over 52 kg up to and including 57 kg
	-63 kg	Middleweight	over 57 kg up to and including 63 kg
	+63 kg	Half-heavyweight	over 63 kg
Senior and Junior Men	-66 kg	Half-lightweight	up to and including 66 kg
	-73 kg	Lightweight	over 66 kg up to and including 73 kg
	-81 kg	Half-middleweight	over 73 kg up to and including 81 kg
	-90 kg	Middleweight	over 81 kg up to and including 90 kg
	+90 kg	Half-heavyweight	over 90 kg
Cadet Men	-60 kg	Half-lightweight	up to and including 60 kg
	-66 kg	Lightweight	over 60 kg up to and including 66 kg
	-73 kg	Half-middleweight	over 66 kg up to and including 73 kg
	-81 kg	Middleweight	over 73 kg up to and including 81 kg
	+81 kg	Half-heavyweight	over 81 kg

1.11 Age Groups

Athletes under 15 years of age are not allowed to compete in any official IJF event, or events organised either under the auspices of the IJF or sanctioned by the IJF. The lower age limit for all IJF competitions is 15 years (calendar year).

The following age categories are recognized by the IJF:

- Cadets - **men** and **women** under 18, age 15, 16 and 17 years (calendar year).
- Juniors - men and women under 21, age 15 to 20 years (calendar year).
- Seniors – men and women, there is only the lower age limit of 15 years (calendar year).

National Federations should use the term youth to define cadets and juniors and any age groups from 15-20 years that are different to the IJF cadet and junior ages.

1.12 Time Duration of Contests

Regulations related to weight categories, age, contest duration and recommendations for Youths.

Note: no athlete less than 15 years old (calendar year) is allowed to take part in any IJF official competition. The additional categories (13/14, 11/12, 9/10 years) are recommendations only.

Female					
SENIORS	-21 YEARS	-18 YEARS	13/14 YEARS	11/12 YEARS	9/10 YEARS
4 minutes	4 minutes	4 minutes	3 minutes	2 minutes	No competition
				- 22 kg	
				- 25 kg	
				- 28 kg	
			- 32 kg	- 32 kg	
			- 36 kg	- 36 kg	
		- 40 kg	- 40 kg	- 40 kg	
		- 44 kg	- 44 kg	- 44 kg	
- 48 kg	- 48 kg	- 48 kg	- 48 kg	- 48 kg	
- 52 kg	- 52 kg	- 52 kg	- 52 kg		
- 57 kg	- 57 kg	- 57 kg	- 57 kg		
- 63 kg	- 63 kg	- 63 kg	- 63 kg		
- 70 kg	- 70 kg	- 70 kg			
- 78 kg	- 78 kg	+ 70 kg			
+ 78 kg	+ 78 kg				

Male					
SENIORS	-21 YEARS	-18 YEARS	13/14 YEARS	11/12 YEARS	9/10 YEARS
4 minutes	4 minutes	4 minutes	3 minutes	2 minutes	No competition
				- 24 kg	
				- 27 kg	
				- 30 kg	
			- 34 kg	- 34 kg	
			- 38 kg	- 38 kg	
			- 42 kg	- 42 kg	
			- 46 kg	- 46 kg	
		- 50 kg	- 50 kg	- 50 kg	
		- 55 kg	- 55 kg		
- 60 kg	- 60 kg	- 60 kg	- 60 kg		
- 66 kg	- 66 kg	- 66 kg	- 66 kg		
- 73 kg	- 73 kg	- 73 kg			
- 81 kg	- 81 kg	- 81 kg			
- 90 kg	- 90 kg	- 90 kg			
-100 kg	-100 kg	+ 90 kg			
+ 100 kg	+ 100 kg				

The IJF do not hold competitions for athletes in the 11/12 years and 13/14 years. The National Federations should design their own national concept.

1.13 Event Outlines

For each IJF WJT event outlines will be published on the IJF website and sent to the National Federations. The deadlines in the outlines must be respected.

1.13.1 Visas

The local organisers will assist with visas where possible but having the correct visa is the responsibility of each participant. Visa applications will only be accepted for people who are inscribed in judobase for the event.

1.13.2 Transportation

The organiser will provide transportation for competing delegations during the competition. This transportation service (including airport transfers) is only offered on the days when the delegations are booked in an official hotel through the organisers. If the delegation misses the transport deadline the organisers are not obliged to provide airport, train or bus station transfers.

1.13.3 Accommodation

All delegates inscribed for an IJF WJT event must stay in one of the official hotels, offered in the outlines by the organisers, for a minimum of two (2) nights, e.g. Total of 4 people inscribed in judobase = 8 nights or more must be reserved.

This rule does not apply to the host National Federation delegates.

The organisers will do their best to provide the first choice of accommodation but as rooms might be limited this cannot be guaranteed. After the accommodation deadline, the organiser cannot promise rooms in the hotels detailed in these outlines and another official hotel may be added. Accommodation cancellation fees will be detailed in the event outlines.

Any damage to hotel property resulting from the stay of a national delegation will be charged to the national federation and must be paid in full.

Delegations are kindly requested not to dry clothing (including judogi) or have training sessions in the corridors of the official hotels.

According to the IJF rule enacted on the 2 December 2012 in Tokyo, "the organising country should not request penalties fee for participating countries who cannot make bank transfers but can pay in cash upon arrival. Those countries who cannot make bank transfers should inform the organisers well in advance that they will pay cash on arrival".

All bank fees and bank transfer costs must be paid by the participating National Federation. If payment is being made by bank transfer the bank information must be inserted correctly and completely on the transfer document and any procedures related to amendment of the bank transfer must be done before arrival. Delegations must ensure that all bank charges are paid at their end so that the organisers receive the correct amount of funds without any deductions. The person attending accreditation must bring proof of the bank transfer.

1.13.4 Training

Training is the responsibility of the organising federation. Planning and scheduling of training sessions will be organised taking into consideration requests made by delegations daily on a first request made first served basis. To book training contact the organisers.

1.13.5 Insurance

National Federations are responsible to ensure their delegates during any IJF WJT event. The organiser of the event and the IJF will not be responsible for any insurance. Nevertheless, the National Judo Federation staging the event shall take all necessary actions to provide insurance coverage against civil liability for the entire duration. The organiser of the event and the IJF have no liability for any claims of injury, illness or death arising from the travelling to and the participation in this event.

1.13.6 Consent for photography/videos/filming

Delegates inscribed by their National Federations for WJT events consent to the IJF and its media partners to use content of them, including data, live results, photographs and/or video recordings (hereafter referred to as Media). This media may be obtained from National Federations and IJF. It will also be acquired by the IJF and its media partners from in and around all IJF WJT event venues. Media could be used in print and digital media formats including print publications, websites, e-marketing, posters banners, advertising, film, broadcast, social media, education purposes and other purposes.

The National Federation must ensure that they have the permission of each delegate or in the case of a minor the permission of the parent/guardian.

If a delegate does not give consent, then the National Federation must inform the International Judo Federation by writing to registration@ijf.org

1.14 Official Notice Boards

All event information (transport times, training schedule, departure schedule etc.) for the delegations will be communicated and posted on the official notice boards in each official hotel and in the warm up area.





COMPETITION SCHEDULES AND SYSTEMS

The competition schedules and systems are the responsibility of the IJF Sport Commission.

2.1 Competition Format and Schedules for the IJF World Judo Tour

The IJF WJT competitions: Grand Prix, Grand Slam, Masters, World Championships Cadets, Juniors, Seniors and Open normally consist of two sessions, the preliminaries and the final block. The competition phases that take place in the sessions depend on the type of event. Any changes to this will be agreed and approved by the IJF Head Sport Director. Depending on the number of participants some rounds may not be required for every category. The competition schedule for non IJF WJT events should be agreed by all interested parties.

IJF Events planned for 2 days (Grand Prix, Grand Slam, Masters)		
	Women	Men
Day 1	-48 kg, -52 kg, -57 kg, -63 kg	-60 kg, -66 kg, -73 kg
Day 2	-70 kg, -78 kg, +78 kg	-81 kg, -90 kg, -100 kg, +100 kg
IJF Events planned for 1 or 2 days (World Championships Open)		
Day 1	Women or Men, Women and Men	
Day 2	Men or Women	
IJF Events planned for 3 days (Grand Prix, Grand Slam, Masters)		
Day 1	-48 kg, -52 kg, -57 kg	-60 kg, -66 kg
Day 2	-63 kg, -70 kg	-73 kg, -81 kg
Day 3	-78 kg, +78 kg	-90 kg, -100 kg, +100 kg
IJF Events planned for 5 days (World Championships Cadets)		
Day 1	-40 kg, -44 kg	-50 kg, -55 kg
Day 2	-48 kg, -52 kg	-60 kg, -66 kg
Day 3	-57 kg, -63 kg	-73 kg, -81 kg
Day 4	-70 kg, +70 kg	-90 kg, +90 kg
Day 5	Mixed Teams	
IJF Events planned for 5 days (World Championships Juniors)		
Day 1	-44 kg, -48 kg	-55 kg, -60 kg
Day 2	-52 kg, -57 kg	-66 kg, -73 kg
Day 3	-63 kg, -70 kg	-81 kg, -90 kg
Day 4	-78 kg, +78 kg	-100 kg, +100 kg
Day 5	Mixed Teams	
IJF Events planned for 8 days (World Championships Seniors)		
Day 1	-48 kg	-60 kg
Day 2	-52 kg	-66 kg
Day 3	-57 kg	-73 kg
Day 4	-63 kg	-81 kg
Day 5	-70 kg	-90 kg
Day 6	-78 kg	-100 kg
Day 7	+78 kg	+100 kg
Day 8	Mixed Teams	

2.2 Competition Systems

The IJF recognises men's and women's competitions. Contests between men and women are not permitted.

There are many different competition elimination bracket systems (refer to Appendix G) that can be used for competitions, direct knockout, quarter-final (last 8) repechage, double repechage, full repechage, round robin etc. Gold, silver and two (2) bronze medals will be awarded except in the case of low numbers.

For all events where world ranking points can be given a uniform system must be used. On the draw sheet the athlete/team on top wears a white judogi and the one below wears a blue judogi.

2.2.1 Direct Knockout

This is a direct elimination format without a repechage. The losers of the semi-finals will both be awarded bronze medals. The winners of the semi-finals will compete for the gold and silver medals. The four athletes losing the quarter-finals are classified equal fifth.

2.2.2 Quarter-final Repechage

In a quarter-final repechage, for each category, the athletes will be divided into two tables by means of a draw, and an elimination system will be used to produce two finalists, who will compete for the gold medal. The athletes defeated in the quarter-final will compete in two repechage contests. The winners of each of these two repechage contests will compete in bronze medal contests against the loser of the semi-final contest of the respective opposite table. The winners (2) of those contests are placed third. The losers (2) are placed fifth. The losers (2) of repechage contests are placed seventh.

2.2.3 Double Repechage

In a double repechage, for each category, the athletes will be divided into two tables by means of a draw, and an elimination system will be used to produce two finalists, who will compete for the gold medal. Athletes who lost to the four semi-finalists compete in the two repechage pools. The winners of each of these two repechage contests (pools) will compete in bronze medal contests against the loser of the semi-final contest of the respective opposite table. The winners (2) of those contests are placed third.

2.2.4 Full Repechage

All participants can compete at least twice, athletes are divided into two tables (pools), A and B, by means of a draw, and then into two groups (sub-pools) within each table: A1, A2, B1 and B2. The elimination system will be used to produce two finalists. All judoka defeated after each round of competition will take part in the repechage of their respective table according to the elimination system. The winner of each repechage will compete against the loser of the final of the opposite table for the two bronze medals. The winners of table A and table B compete for the gold and silver medals.

2.2.5 Round Robin

If there are low numbers a "Round Robin" system may be used, and this is defined as a system where each athlete or team will compete against the other.



The following Round Robin rules to define the winners are used:

Rule 1. Number of wins.

Rule 2. If equal the sum of points for scores: Ippon/waza-ari-awasete-ippou = 10, Waza-ari = 1. All scores achieved will be counted for both the winner and loser for each contest in the category. A player can get a maximum of 10 points per contest. Points are same regardless if they are achieved in the regular contest time or during golden score.

Rule 3. Direct comparison: if two contestants have an equal number of wins and sum of points for scores, the contestant who won the contest between them is defined as better.

Rule 4. If there are an equal number of wins and no direct comparison possible because of "beating in circle": the shortest accumulated time of all winning contests will decide.

Rule 5. If there is a case of equal time: weight at the weigh-in. The athlete with the lower weight is defined as better.

Rule 6. In case of same weight at the weigh-in: decision contests. A knockout system between the involved players will be used. A new draw must be performed. For example in the case of three athletes: one contest between two players will be held. The winner of this contest will compete against the third player to get a final decision.

2.3 Regulations for Low Numbers of Athletes or Teams

If there are one (1) to five (5) athletes or teams the low numbers rules are applied.

If there are six (6) athletes in a category and one or more does not pass the weigh-in, then the category should be redrawn to follow the low number rules.

If there are five (5) or four (4) athletes in a category and one or more does not pass the weigh-in, then the category should be redrawn.

If there are six (6) teams and one or more teams cannot compete, then there should be a redrawn to follow the low number rules.

If there are five (5) or four (4) teams in a category and one or more teams does not comply with the weigh-in, then the category should be redrawn.

2.3.1 Low Numbers Rules for IJF World Ranking List Individual and Mixed Team Events

a) If there are five (5) athletes or teams, there will be two (2) athletes on one side of the table who will have a single contest for the access to the final, the three others on the other side of the table compete in the round robin system to classify them. The defeated athlete of the single contest must compete with the second one coming from the round robin elimination for the bronze medal (only one bronze medal awarded). The winner of the single contest meets the winner coming from the round robin system for gold and silver.

b) If there are four (4) athletes or teams, there will be two single contests, then a contest between the two losers for the single bronze medal and a contest between the two winners for the gold and silver medals.

c) If there are three (3) athletes or teams a round robin system will be held in the elimination round. The best and the second best will compete in a final. A bronze medal will be given if one contest was won.

d) If there are two (2) athletes or teams one final will be held and a gold and silver medal will be awarded.

2.3.2 Low Numbers Rules for Other Individual and Team Events

For all other events, the following round robin rules can be applied instead:

a) If there are 5 athletes or teams - gold and silver and one bronze for the single 3rd place.

b) If there are 4 athletes or teams - gold and silver and one bronze for the single 3rd place.

c) If there are 3 athletes or teams - gold and silver and no bronze for the 3rd place except if they have won one contest.

d) If there are 2 athletes or teams it will be the best of two contests and if the wins are equal (1-1), the third contest will decide. Gold and silver medals given.

Events	System of competition for 6 or more athletes	System of competition for 5 or less athletes
Senior and Mixed Teams World Ranking List events	Quarter-final repechage	Low numbers rules for WRL events
Continental Opens		
Continental Championships		
Grand Prix		
Grand Slam		
Masters		
World Championships Senior		
World Championships Open		
World Championships Mixed Teams Continental Championships Mixed Teams		
World Championships Cadet	Quarter-final repechage	Low numbers rules for WRL events
World Championships Junior		
World Championships Cadet Mixed Teams		
World Championships Junior Mixed Teams		
Cadet and Junior World Ranking List events	Double repechage	Low numbers rules for WRL events
Continental Cups		
Continental Championships		
Continental Championships Mixed Teams	Full repechage	Low numbers rules for WRL events
Youth Olympic Games	Direct knockout	Not applicable
Youth Olympic Games Mixed Teams	Quarter-final repechage	Not applicable
Olympic Games Individual and Mixed Teams	Organiser's choice	Low numbers rules for WRL events or low numbers rules for other events
Non-World Ranking List Events		

2.4 Competition System for Mixed Team and Team Events

The system of competition for IJF Mixed Teams events will be the elimination system with quarter-final repechage (refer to section 2.2.2 for a full description). For other team events, different types of systems can be used such as double repechage, full repechage or direct knockout. Gold, silver and two (2) bronze medals will be awarded except in the case of low numbers.

2.4.1 Regulations for Mixed Team Events

Mixed Teams senior, junior and cadet: all nations having a full team (must have athletes able to compete in all 6 categories) can enter. Each team will consist of up to six (6) athletes (3 women and 3 men) and has the possibility to have up to six (6) reserves (3 women and 3 men). If there are injuries or illness during the competition a team can compete with a minimum of four (4) athletes. A total of 12 athletes can be inscribed with a maximum of two (2) athletes per category. The top four (4) teams from the IJF Mixed Teams World Ranking List (WRL) will be seeded.

Weigh-in rules can be found in section 6. During **senior and junior mixed teams competitions** each athlete is entitled to compete in their own weight category or in the next higher category. **During cadet mixed team competitions athletes have to compete in their inscribed mixed team category and cannot be moved one team category higher.**

During the contests, the non-competing athletes must stay within a marked area on the field of play behind the coaches' chair. Reserve athletes must not enter the field of play.

Two (2) coaches per team will be allowed to enter the Field of Play.

A draw will be made for the starting category for the first round. The following rounds will start with the next category in the sequence.

Example: Senior Mixed Teams - drawn category is -73 kg

1st round: -73, -70, -90, +70, +90, -57 kg

2nd round: -70, -90, +70, +90, -57, -73 kg

Quarter-final: -90, +70, +90, -57, -73, -70 kg

Repechage and semi-final: +70, +90, -57, -73, -70, -90 kg

Bronze and final: +90, -57, -73, -70, -90, +70 kg

Before each match the team leader must select the athletes for each contest. From the maximum of two athletes inscribed in each category they can select one. If the team has the possibility to put an inscribed athlete in a category, they must do so. An athlete cannot be rested for one match and return for the next unless they have been replaced by the other inscribed athlete.

If the team has no athlete in a category, they should select the "no competitor" option.

For the first round the lists must be returned at least 30 minutes before the start of the competition. For other rounds it must be returned 5 minutes after receiving the list from competition management. Once it is returned to competition management it cannot be changed.

Duration of each contest: women four (4) minutes and men four (4) minutes (real time). After the team bow the byes are displayed on the scoreboard and wins are given.

Example: If blue team has one category empty: 1:0

Example: if both teams have a different category empty: 1:1

Example: if both teams have the same category empty: 0:0 (this is the only case when we stop a match when a team has reached 3 wins).

These byes are skipped later, no player needs to return to the tatami to bow again if there is no contest to be fought.

The first team reaching the majority of wins is declared the winner. The remaining contests will not be fought.

It is compulsory that all athletes listed for the match compete until the team reaches the winning result. If an athlete refuses to compete the team will be disqualified.

If one team does not arrive for a match, the other team will be declared the winner.

If there are an equal number of wins at the end of the match, a draw is done from all categories regardless if the team has a player or not (if both teams don't have a player in the same category, this category will be not included in draw). The athletes in the drawn category will refight a golden score contest. The draw is done by computer and displayed on the athlete and public (big screen) scoreboards.

Youth Olympic Games Mixed Teams - the team will consist of four (4) men and four (4) women from different NOCs. For Youth Olympic Games Mixed Teams, there will be no seeding.

2.4.2 Regulations for Female and Male Team Events

Each team will consist of up to five (5) athletes and has the possibility to have up to five (5) reserves. A team must consist of a minimum of three (3) athletes. A total of 10 athletes can be inscribed with a maximum of two (2) athletes per category. One (1) coach per team will be allowed to enter the Field of Play.

Weigh-in rules can be found in section 6. During female and male team events each athlete is entitled to compete in their own weight category or in the next higher category.

During the contests, the non-competing athletes must stay within a marked area on the field of play behind the coaches' chair. Reserve athletes must not enter the field of play.

Two (2) coaches per team will be allowed to enter the Field of Play.

The contests in female and male team matches will be fought from the lightest weight to the highest weight. Before each match the team leader must select the athletes for each contest. From the maximum of two athletes inscribed in each category they can select one. If the team has the possibility to put an inscribed athlete in a category, they must do so. An athlete cannot be rested for one match and return for the next unless they have been replaced by the other inscribed

athlete.

If the team has no athlete in a category, they should select the “no competitor” option.

For the first round the lists must be returned at least 30 minutes before the start of the competition. For other rounds it must be returned 5 minutes after receiving the list from competition management. Once it is returned to competition management it cannot be changed.

Duration of each contest: women four (4) minutes and men four (4) minutes (real time). After the team bow the byes are displayed on the scoreboard and wins are given.

Example: If blue team has one category empty: 1:0

Example: if both teams have a different category empty: 1:1

Example: if both teams have the same category empty: 0:0 (this is the only case when we stop a match when a team has reached 3 wins).

These byes are skipped later, no player needs to return to the tatami to bow again if there is no contest to be fought.

The first team reaching the majority of wins is declared the winner. The remaining contests will not be fought.

It is compulsory that all athletes listed for the match compete until the team reaches the winning result. If an athlete refuses to compete the team will be disqualified.

If one team does not arrive for a match, the other team will be declared the winner.

If there are an equal number of wins at the end of the match, a draw is done from all categories regardless if the team has a player or not (if both teams don't have a player in the same category, this category will be not included in draw). The athletes in the drawn category will refight a golden score contest. The draw is done by computer and displayed on the athlete and public (big screen) scoreboards.





WORLD RANKING LIST AND IJF RANKING EVENTS

The world ranking lists (WRL) are the responsibility of the IJF Sport Commission and are managed by the IJF IT Team. The WRL can be found at www.ijf.org and for assistance please contact registration@ijf.org

3.1 IJF Senior World Ranking List

Athletes can earn WRL points by competing in IJF WJT events, World Championships Juniors and Continental Opens.

		Continental Open International Entry	Continental Championships Continental Entry	World Championships Juniors International Entry	Grand Prix International Entry	Grand Slam International Entry	Masters Top 36 Invitation Entry	World Championships Seniors International entry	
GENERAL	Seeding	WRL TOP 8 placing Rest: Nation Distribution	WRL TOP 8 placing Rest: Nation Distribution	WRL TOP 8 placing Rest: Nation Distribution	WRL TOP 8 placing Rest: Nation Distribution	WRL TOP 8 placing Rest: Nation Distribution	WRL TOP 8 placing Rest: Nation Distribution	WRL TOP 8 placing Rest: Nation Distribution	
	System	Quarter-final Repechage	Quarter-final Repechage	Quarter-final Repechage	Quarter-final Repechage	Quarter-final Repechage	Quarter-final Repechage	Quarter-final Repechage	
	Repechage	Last 8 Repechage	Last 8 Repechage	Last 8 Repechage	Last 8 Repechage	Last 8 Repechage	Last 8 Repechage	Last 8 Repechage	
	Bronze	2 Bronze	2 Bronze	2 Bronze	2 Bronze	2 Bronze	2 Bronze	2 Bronze	
	Number of athletes (per category per country)	No limit	Maximum of 2 per category per country (not exceeding the total number of 9 men and 9 women per country).	Maximum of 2 per category per country (not exceeding the total number of 9 men and 9 women per country). max. 2 per country max. 2 domestics = 28 total (best 9 men and 9 women only for ranking list)	max. 2 per country max. 4 domestics (best 2 only for ranking list)	max. 2 per country max. 4 domestics (best 2 only for ranking list)	No limit	Maximum of 2 per category per country (not exceeding the total number of 9 men and 9 women per country).	
WRL Points	1st place	100	700	700	700	1000	1800	2000	
	2nd place	70	490	490	490	700	1260	1400	
	3rd place	50	350	350	350	500	900	1000	
	5th place	36	252	252	252	360	648	720	
	7th place	26	182	182	182	260	468	520	
	1/16th	16	112	112	112	160	288	320	
	1/32nd	12	84	84	84	120	-	240	
	1 contest won	10	70	70	70	100	216	200	
	Participation	-	6	6	6	6	10	200	20

The five best results during the 12-month period will count plus one extra (6th) result from the Continental Championships or Masters. In a case where the athlete competes in both events (Continental Championships and Masters) then the higher point score will count as the 6th result, and the lower point score may count for the five best results in the WRL.



The points will count as follows:

Look back 12 months from today	• Five best results plus one result	100%
Look back 13-24 months	• Five best results plus one result	50%

The points for each tournament will expire as follows:

In the first 12 months after the tournament the points will count 100%.

After 12 months, the points will be reduced to 50%.

After 24 months, the points will be reduced to 0. The dividing line is the following week (week number) in which the tournament was held.

Example: If a tournament is held in week 17 of 2010, the points are reduced to half on the beginning of week 18 in 2011 and expire at the beginning of week 18 in 2012. The beginning of the week is defined as Monday.

Exception: For the equal treatment of all Continents, the Continental Championships Senior are treated as if they were held in week number 17 regardless of the actual week number that they are organised in. The points reduction or expiration will therefore be done on Monday of week number 18.

Participation points will be given for Grand Prix, Grand Slam, Masters, Continental Championships and World Championships. In a Continental Open a minimum of one contest must be won to get points.

At Grand Prix and Grand Slam events only the two best domestic athletes can obtain points for the WRL. In case of equality the points will be automatically given to the highest ranked athlete. If still equal, the domestic federation will decide.

In case of equality of total points, the higher ranking will be decided by:

The highest sum of the current points from all World Championships.

The highest sum of the current points from all Grand Prix, Grand Slams and Masters.

The highest current points from one single event, then, if needed, the second highest, and so on.

If the athletes are still equal the IJF Executive Committee, in the case of Olympic Qualification, will make the decision.

Athletes participating in the World Championships Juniors, will be added to the senior WRL and will be given the same points as those given for a Grand Prix. For the junior WRL the points will be as in section 3.4.

Tokyo 2020 Olympic Games:

For the World Ranking List from 25 May 2020 the points of

- Hohhot Grand Prix 2018 will be included at 50% and Hohhot Grand Prix 2019 will be included at 100%
- Guangzhou Masters 2018 will be included at 50%, Masters 2019 and Masters 2020 will both be included at 100% as these events are part of the Olympic Qualification period.

The WRL points will return to their normal expiry dates from 1 June 2020.

3.2 IJF Mixed Teams World Ranking List

The Mixed Teams World Ranking List for cadets, juniors and seniors will consist of points from the Continental Championships Mixed Teams and World Championships Mixed Teams.

Seniors

Placing	Continental Championship points	World Championship points
1st place	4200	12000
2nd place	2940	8400
3rd place	2100	6000
5th place	1512	4320
7th place	1092	3120
1/16th	672	1920
1/32nd	504	1440

Juniors and cadets

Placing	Continental Championship points	World Championship points
1st place	700	2000
2nd place	490	1400
3rd place	350	1000
5th place	252	720
7th place	182	520
1/16th	112	320
1/32nd	84	240

The Ranking :

The results will count starting from the World Championships Mixed Team 2017. Points will be allocated even if no match was won.

The points for each Mixed Teams Championships will expire as follows :

- In the first 12 months after the Championship the points will count 100%
- After 12 months points will be reduced to 50%
- After 24 months points will be reduced to 0%

The dividing line is the following week (week number) in which the Championship was held. The beginning of the week is defined as Monday.

Exception: For the equal treatment of all Continents, the Continental Championships Senior Mixed Teams are treated as if they were held in week number 17 and the Continental Championships Junior Mixed Teams and Cadet Mixed Teams week number 26 regardless of the actual week number that they are organised in. The points reduction or expiration will therefore be done, for seniors on Monday of week number 18 and for juniors and cadets on Monday of week number 27.

Additional rules in the case of equality of total points, the higher ranking will be decided by:

- The highest sum of the current points from all World Championships Mixed Teams.
- The highest sum of the current points from all Continental Championships Mixed Teams.

3.3 Nation World Ranking List

The WRL for nations was established and this ranking consists of the sum of the current WRL points for all athletes plus the sum of the current Mixed Team WRL for that nation.

3.4 IJF Junior and Cadet World Ranking Lists

Athletes can earn WRL points by competing in Continental Cups, Continental Championships and World Championships for Junior and Cadet.

	Continental Cup	Continental Championships	World Championships Junior/ Cadet
1st place	100	200	500
2nd place	60	120	300
3rd place	40	80	200
5th place	20	40	100
7th place	16	32	80
Each contest won	2	6	12
Participation	-	2	4

The three best results during the 12-month period will count plus the result from the Continental Championships Junior and Cadet and the World Championships Junior and Cadet, if applicable.

The points will count as follows:

Look back 12 months from today	<ul style="list-style-type: none"> • Three best results from Continental Cup • Result from last Continental Championships • Result from last World Championships 	100%
Look back 13-24 months	<ul style="list-style-type: none"> • Three best results from Continental Cup • Result from previous Continental Championships • Result from last World Championships 	50%

The points for each tournament will expire as follows:

- In the first 12 months after the tournament the points will count 100%.
- After 12 months, the points will be reduced to 50%.
- After 24 months, the points will be reduced to 0. The dividing line is the following week (week number) in which the tournament was held.

Example: If the tournament is held in week 17 of 2014, the points are reduced to half at the beginning of week 18 in 2015 and expired at the beginning of week 18 in 2016. The beginning of the week is defined as Monday.

Exception: For the equal treatment of all Continents, the Continental Championships Junior and Cadet are treated as if they were held in week number 26 regardless of the actual week number that they are organised in. The points reduction or expiration will therefore be done on Monday of week number 27.

Participation points will be given for Continental Championships Junior and Cadet and World Championships Junior and Cadet. In a Continental Cup Junior and Cadet a minimum of one contest must be won to get points.

In case of equality of total points, the higher ranking will be decided by:

- The highest sum of the current points from all World Championships.
- The highest sum of the current points from all Continental Championships.
- The highest sum of the current points from all Continental Cups.
- The highest current points from one single event, then, if needed, the second highest, and so on.

Note: For the Youth Olympic Games only the last three criteria above are relevant as there are no World Championships during the qualification period.

If the athletes are still equal the IJF Executive Committee, in the case of Youth Olympic qualification, will make the final decision.

3.5 Additional Rules

An athlete is considered to be in the competition only once they pass the official weigh-in. Anyone not passing the weigh-in will be removed from the contest sheet. The contest order will be re-numbered. Possible opponents will be moved forward to the next round with a bye. If the opponent wins no other contests, then no WRL points will be given for this bye except participation points (if applicable).

If an athlete, who passed the official weigh-in, does not come to the tatami his opponent must come to the tatami and bow. He will be declared the winner by fusen-gachi and WRL points will be given.

When an athlete loses a contest by a direct hansoku-make for acts against the spirit of judo, ranking points will be assigned for the position that the athlete reached in the competition. However, points, medals and prize money may be removed depending on the results of any further disciplinary action.

If athletes change their nationality out of the Olympic Qualification period, they will keep all WRL points for seeding purposes.

If athletes change their nationality during the Olympic Qualification period, they will lose all WRL points and will start with zero (0) points.



ENTRIES AND ACCREDITATION

Entries for IJF events are the responsibility of the IJF Sport Commission and are managed by the IJF IT Team. For assistance on the entries please contact registration@ijf.org

4.1 Entries for IJF WJT Events

Only entries of member National Judo Federations will be accepted.

In some exceptional cases, the IJF can, in order to protect an athlete's career, inscribe an athlete into an IJF event, under his/her National Federation Flag or under the IJF flag, according to the specificity of the case.

The name and date of birth of each delegate should match that of their passport. If the person wishes to be known by another name, they should write to the IJF General Secretariat (gs@ijf.org) with copy to registration@ijf.org for approval. If someone has a name change or their name/date of birth is incorrect, the National Federation should send a copy of the **valid** passport to registration@ijf.org so that their judobase record can be updated.

It is the responsibility of the National Federation to ensure that the athletes are of the correct age for the competition that the athlete wants to enter. Any National Federation entering athletes that are not of the correct age will be subject to an investigation and possible disciplinary action.

An athlete classified in any IJF WRL (either cadet, junior and senior) is not authorised to take part in an international competition of any combat sport, other than judo, unless authorisation has been given by the IJF.

The automatic sanction system for athletes who did not ask the IJF for authorisation or did not respect the IJF decision is applicable as follows:

- 1st violation: 2 months suspension from IJF and Continental Unions competitions and other judo activities e.g. training camp.
- 2nd violation: 2 years suspension from IJF and Continental Unions competitions and other judo activities e.g. training camp.

All participating delegates must have a valid IJF card and be inscribed in judobase (www.judobase.org) by their National Federation by the event deadline. Any delegate is eligible to inscribe in a competition provided he is:

- Not under a disciplinary suspension.
- Not under suspension for anti-doping rule violation.
- Not under medical suspension.
- Healthy and do not carry any communicable diseases that may risk other delegates' health.

The President of a National Federation cannot act as a coach or referee during events organised by the IJF.

A National Federation coach can be accredited for **ONLY** one country per event except when prior permission has been given by the IJF after confirmation that all National Federations involved agree.

Athletes can be entered in **ONLY** one weight category per IJF WRL event. Each person can only be inscribed with one function (i.e. athlete, coach, referee, team official etc.) per event. This rule is not the same for veteran events (Appendix A).

After the deadline changes can be made one to one, like for like, due to injury or illness. For example, an injured athlete can be replaced by another athlete regardless of gender or weight category. An ill team official can be replaced by

another team official etc. The process is as follows:

- Until 20 days before draw, the correct names of the complete delegation (athletes and officials) must be registered online at IJF registration page (www.judobase.org). During the period of Olympic qualification, for events where Olympic qualification points can be earned, no additional athletes (under any circumstances) can be inscribed after this deadline.
- Until 5 days before draw if a delegation has replacements and/or cancellations these changes must be entered online at www.judobase.org.
- Until start of accreditation, any last-minute replacements or cancellations must be sent to the IJF registration e-mail: registration@ijf.org. A confirmation will be sent from the IJF. Emails to registration@ijf.org only cancel the delegate for the competition, for accommodation cancellations you must email the local organising committee directly.

During accreditation, registered athletes can be replaced by other athletes and registered officials can be replaced by other officials.

4.2 Cancellation of Athletes

Where possible, cancellations should be made before accreditation. Any cancellation of an athlete during accreditation without replacement will result in a penalty (see below):

- If registered athletes are cancelled during accreditation without previous notification to IJF, a penalty of 100 USD per athlete will apply.
- This penalty will be charged by the IJF to the National Federation.
- The local organiser has the right to charge cancellation fees as detailed in the event outlines.

4.3 Number of Entries

For IJF events the number of entries permitted will be limited as follows:

World Championships Seniors

Each National Federation may enter:

- Up to 9 entries for women with maximum 2 athletes per category.
- Up to 9 entries for men with maximum 2 athletes per category.

There is no open category.

World Championships Open

Each National Federation may enter:

- Up to 4 entries for women.
- Up to 4 entries for men.

World Championships Juniors

Each National Federation may enter:

- Up to 9 entries for women with maximum 2 athletes per category.
- Up to 9 entries for men with maximum 2 athletes per category.

The host country may enter:

- Up to 14 entries for women with maximum 2 athletes per category.
- Up to 14 entries for men with maximum 2 athletes per category.

However, from the host country only the best results from 9 men and 9 women will be considered for the World Ranking List Juniors and Seniors.

There is no open category.

World Championships Cadets

Each National Federation may enter:

- Up to 10 entries for women with maximum 2 athletes per category.
- Up to 10 entries for men with maximum 2 athletes per category.

The host country may enter:

- Up to 16 entries for women with maximum 2 athletes per category.
- Up to 16 entries for men with maximum 2 athletes per category.

However, from the host country only the best results from 10 men and 10 women will be considered for the World Ranking List Cadets.

There is no open category.

World Championships Mixed Teams

Each National Federation may enter:

- 2 athletes per category.

World Masters

- 36 athletes in the WRL in each weight category will be invited.

If an athlete qualifies in more than one category, the National Federation can decide in which category they will take part. The National Federation will be given a deadline for this decision. If they do not decide on time, the IJF will take the decision based on the highest-ranking position and that will be the category that is chosen.

Athletes can only be entered in the weight category for which they have been selected.

The organising country has the right to have a minimum of two (2) athletes in each category. If they do not qualify anyone in the top 36 up to two domestic athletes can participate as the 37th and 38th athlete.

No reserve athletes will be invited.

Grand Prix and Grand Slam

Each National Federation may enter:

- Up to 14 entries for women with maximum 2 athletes per category.
- Up to 14 entries for men with maximum 2 athletes per category.

The host country may enter:

- Up to 28 entries for women with maximum 4 athletes per category.
- Up to 28 entries for men with maximum 4 athletes per category.

However, from the host country only the best results from 14 men and 14 women will be considered for the World Ranking Seniors.

Continental Opens and Cups

There is no limit to the number of athletes from the same country that can be inscribed in a category.

4.4 Accreditation

The purpose of accreditation is to identify people and their roles at events and allow them necessary access to perform their roles.

At least one team delegate must attend on time to confirm the entries of all athletes and officials with a signature on the delegation confirmation list. A delayed appearance or no-show may result in the exclusion of all participants from the draw and the event. In case of unforeseen delay of arrival or cancellation, the National Federation must immediately contact both the organiser and the IJF registration team (registration@ijf.org).

For each official team member from a national delegation (athletes, coach, team official, doctor etc.) an accreditation card is issued by the IJF during the official registration. A delegate should never wear another delegate's accreditation card. The accreditation card remains the property of the IJF and can be withdrawn, with immediate effect, at the IJF's sole discretion.

The accreditation card is valid for the duration of the competition and is the personal identity document of the delegate for all security and access controls. This card contains: last (family) name, first (given) name, country, IJF ID number, a picture and for athletes their weight category and WRL position.

At World Championships and whenever it is necessary to verify the age and/or nationality of an athlete a member of the IJF Sport Commission or its representative will check the passport or national identity card (a high-quality photocopy or scan will also be accepted).

Quota for officials for accreditations (includes team officials, coaches, doctors and physiotherapists):

- One – four (1-4) competitors = three (3) officials.
- Five – nine (5-9) competitors = five (5) officials.
- 10 or more competitors = seven (7) officials.

The accreditations for National Federation president, referee and judoka are not included in the above calculation. The fee for additional team official(s) (who must be inscribed in judobase) is 100 US\$ per accreditation, to be paid to the organisers.

At the accreditation stage the local organising committee must organise at least two stations for financial payments. One for teams with no changes and one or more for teams that need to make changes.





DRAW

The draw is the responsibility of the IJF Sport Commission.

Men: 242

Women: 147

Total: 389
Nations: 54

5.1 Draw Regulations

For all IJF World Championships, Masters, Grand Slams and Grand Prix the draw will take place at 14:00 the day before the competition. For other events, such as the Olympic Games and other Multi-Sport events, the date and time of the draw will be agreed by the IJF Sport Commission.

After the closing of accreditation and before the start of the draw the lists of athletes by category will be posted outside the draw room. Any errors or omissions should be reported to the IJF IT Team before the start of the draw.

A maximum of **two (2)** delegates per National Federation may attend the draw.

Dress code: formal suit (jacket, trousers, shirt and tie for men; jacket, trousers/skirt/dress, blouse for women) and formal shoes.

The draw will be carried out by computer with the use of the IJF software (or other software if IJF authorised) under the direction of the IJF Sport Director assisted by the IJF IT Team and Sport Commission.

The organising committee shall distribute copies of the draw to each participating delegation no later than 30 minutes after the draw is finished.

5.2 Seeding for IJF WJT Events

For the World Championships, Masters, Grand Slams, Grand Prix, Continental Opens and Cadet and Junior Continental Cups up to a maximum of the top eight athletes among the entered athletes in each weight category will be seeded based on their IJF WRL position.

For the rest of the draw separation by nations will be respected. However, seeding position will take priority over separation by nation.

For the World Championships Open there will be no seeding only separation by nations.

For the World Mixed Team Championships teams the top four (4) teams, from the IJF Mixed Teams WRL will be seeded.

In theory, seeding should separate the strongest competitors in each category, so that they meet at as late a stage as possible in the chosen method of elimination.

For example, the best two players should not meet until the final and the top four until the semi-final and the top eight until the quarter-finals.

Where athletes/teams have the same ranking position, the draw system will automatically do a pre-draw to define the athlete seeding position.

Seeding in elimination bracket system is set up in order to have the draw placing the:

- Number one (1) seed vs. the number eight (8) seed in Pool A.
- Number two (2) seed vs. the number seven (7) seed in Pool C.
- Number three (3) seed vs. the number six (6) seed in Pool D.
- Number (4) seed vs. the number five (5) seed in Pool B.

Seeded athletes are always placed in the same position on the draw sheet.

Seeding in the low numbers 3+2 system is set up in order to have the draw placing the number one (1) seed vs. the number five (5) seed in the lower half while the number two (2), three (3) and number four (4) seeds are in the upper Round Robin half.

Seeded athletes/teams, when possible, do not have to compete in the first round.

In a category, seeding position has the priority over nationality division of the athletes. This means that athletes of the same country may end up in the same pool because of their seeding position or because there is no other possible position for them due to other ranking of the other athletes.

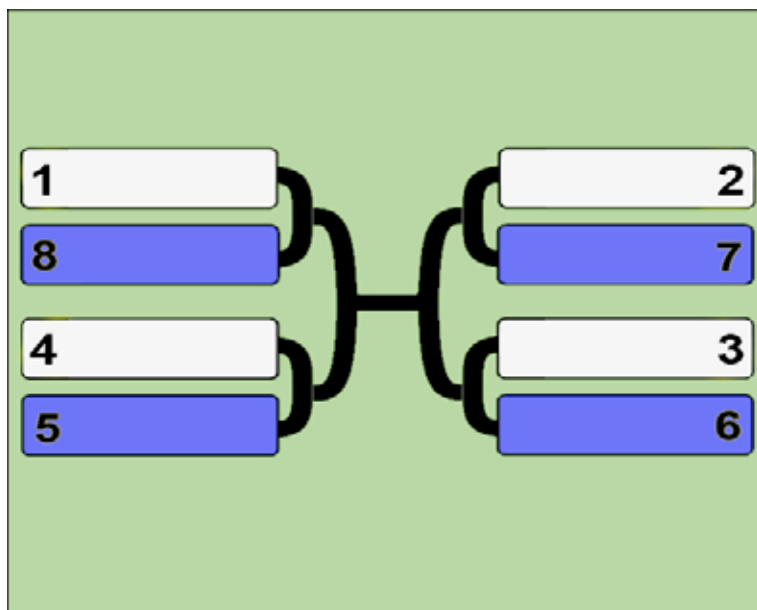

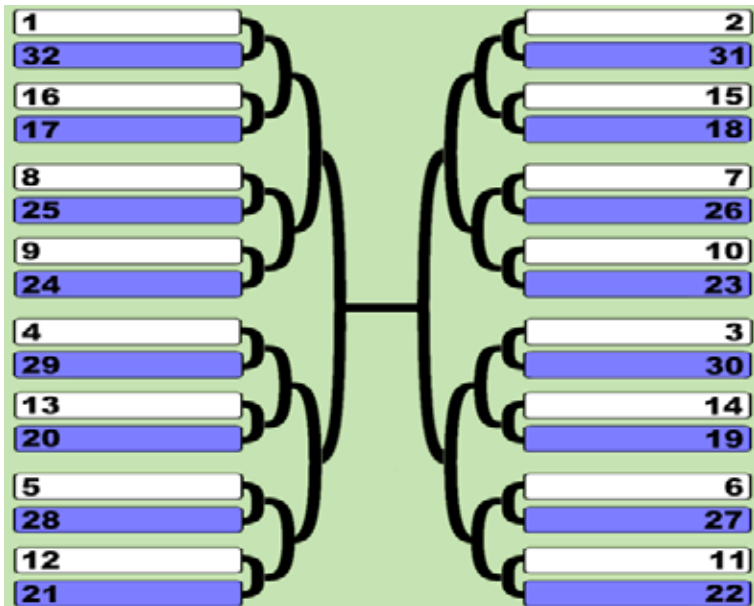
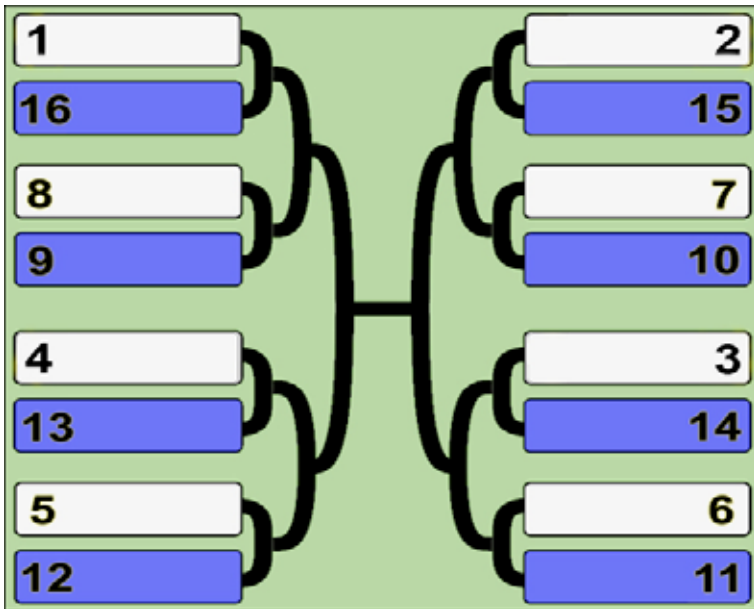



WEIGH-IN AND JUDO GI BACKNUMBER CONTROL

The weigh-in is the responsibility of the IJF Sport Commission. The judogi backnumber control is the responsibility of the IJF Education and Coaching Commission.

6.1 Location of the Weigh-in and Judogi Backnumber Control

The judogi backnumber control and weigh-in can take place in a maximum of two locations simultaneously, either in the competition venue or in the official hotels allocated by organisers for participating delegations.

The members of the Education Commission will check both judogi (white and blue). They will control any worn-out areas particularly on the collar and lapel, the colour, the IJF official label (obligatory), judogi brand (obligatory), national emblem, advertising, backnumber stitching, any visible stains. This service will start 30 minutes before the unofficial weigh-in. Only if the judogi are compliant with the IJF rules will sponsor labels be given. Organisers should provide for the backnumber check a room, with sufficient space, and volunteers. Waste basket papers should be provided.

Organisers should provide for the backnumber check a room, with sufficient space, and volunteers.

The official weigh-in should be held in separate rooms for men and women and enough calibrated electronic scales showing only one decimal place i.e. 51.9 kg, 154.6 kg. If the scales show more than one decimal place the additional decimal places must be covered by tape. If more than one scale is being used, then the weight category to be controlled should be clearly indicated beside that scale. A solid floor is preferred but if the room has a carpet the scales should be placed on a large piece of solid wood.

6.2 Weigh-in Rules

For IJF events the official weigh-in is organised one day before the competition at 20:00. If for any reason (i.e. Olympic Games opening ceremony) a different time is proposed, it shall be agreed by the IJF Sport Commission.

The official weigh-in period shall be between 30 – 60 minutes. At least one set of test scales should be available (from the arrival of the first delegation) in all official hotels between 08:00 – 22:00 for athletes to check their weight.

Athletes are allowed to check their weight on the official weigh-in scales 30 minutes before the official weigh-in commences. There is no limit to the number of times each athlete may check their weight during the time of the unofficial weigh-in.

6.2.1 Individual Events Weigh-In

Junior and senior athletes must be within the weight limits of a category in which they are inscribed. There is no tolerance.

In the cadets age category athletes are NOT allowed to remove their underclothing (men – underpants, women – underpants and bra); to compensate an additional 100 grams will be allowed i.e. for the category -44 kg the limit will be -44.1 kg.

6.2.2 Female and Male Teams and Mixed Teams Weigh-in

The athletes must be within the weight limits of the category in which they are inscribed.

There is 2 kg tolerance for athletes who competed in the preceding individual competition (they must have competed in at least one contest) and NO tolerance for athletes who are only inscribed for the team competition.

The details of the weigh-in will be described in the outlines for the event. Event organisers should take into consideration that if an athlete is competing in an individual event the day before a team competition and is not registered in the plus categories they should not have to weigh-in on that day.

During the competition, an athlete may compete in one category higher than the category in which they are inscribed. Before the start of the official weigh-in the coach can update the team list.

6.3 Official Weigh-in Procedure

The organisers shall make available a minimum of two national referees/officials per each official scale. One to check the passport and weight of the athlete and one to record the exact weight on the official weigh-in list. An additional official/volunteer should also be available to control the flow of athletes. To protect the privacy of the athletes, officials supervising the weigh-in must be of the same gender as the athletes.

The IJF IT team in charge of the event shall make available one copy of the weigh-in list for each weight category for the organiser and one copy for the members of the Sport Commission conducting the weigh-in before the scheduled start of the official weigh-in period.

Photography or filming is not permitted in the weigh-in area.

Procedure:

- All coaches and other team delegates must leave the weigh-in room before the start of the official weigh-in.
- Athletes can stand on the scales only once during the official weigh-in period.
- Athletes shall bring to the weigh-in their IJF accreditation card issued for the competition and their passport or an official identification document with photo. Athletes shall present both documents to the official who will verify their identity.
- The official then invites the athletes to stand on the scales.
- Athletes shall weigh-in wearing only underclothing (men – underpants, women – underpants and bra). Any head covering, watches, glasses, socks, jewellery and body piercings must be removed.
- Athletes are allowed to remove their underclothing – without stepping off the scales - to ensure they reach the minimum or the maximum weight limit of the weight category in which they are entered.
- The official supervising the weigh-in shall note and record the weight of the athlete in kilograms to one decimal point i.e. 51.9 kg, 73.0 kg.
- Athletes steps off the scales.

6.3.1 Failure to Appear for the Weigh-in

Should an athlete fail to appear for weigh-in during the official weigh-in period, this shall be noted beside his name on the official weigh-in list. A weigh-in official and the IJF delegate shall sign the notation. The athlete will be excluded from competing in that weight category.

6.3.2 Failure to Weigh-in Within the Prescribed Limits of a Category

Should an athlete weigh either above or below the prescribed limits for the category in which he is entered, the exact weight shall be recorded in the usual manner. The weight shall be circled and signed by a weigh-in official, and a member of the Sport Commission and by the athlete himself or a member of his delegation. The athlete shall be excluded from competing in that weight category.

6.3.3 Failure to Comply with Official Directions or with the Requirements of the IJF SOR

If at any stage during the weigh-in period, an athlete fails to comply with the directions of any weigh-in official or an IJF delegate or fails to comply with the requirements of the IJF SOR, the athlete shall be prevented from participating in the weigh-in and the nature of the infraction brought immediately to the attention of the Sport Director of the IJF.

6.3.4 After Weigh-in Procedure

Anyone not passing the official weigh-in (through not appearing, failing the weight or failing to comply with official directions) will be removed from the competition and the revised draw sheet will be posted on the official notice board in the warm up area. Their original opponent will pass to the next round and this will be considered their first contest.

6.4 Random Weigh-In

The random weigh-in is the responsibility of the IJF Education and Coaching Commission. Random weight checks for cadets, junior and senior athletes may be organised before the first contests on each day. If the competition has different starting blocks scheduled, then the relevant random weigh-in times can also be different. For IJF WJT events the random weigh-in takes place one hour before the start of the competition each day. The weigh-in will last 45 minutes.

The rules will be the same as those of the official weigh-in with the exception that the athletes do not need to bring their passports, as their accreditation is sufficient for identification. The weight of the athlete cannot be more than 5 % higher than the official maximum weight limit of the category. The drawn athletes will be given only one chance for an unofficial weigh in. There will be no random weigh-in for IJF Mixed Team events.

6.4.1 Draw of the Athletes (individual events)

The draw of the athletes will be done by means of software on a laptop, one (1) hour before the start of the competition. This will be done at the place of the IJF IT person running the competition. Four athletes per category (except those that are plus categories) will be drawn.

6.4.2 Collecting the Athletes

The list of named athletes drawn for the random weigh-in will be officially posted on the official notice board placed near the warm up area.

6.4.3 Weigh-in Procedure

Four volunteers (two men and two women) will operate the weigh-in. Two volunteers will identify the athletes and the two others will proceed with the weigh-in in two separate private rooms, one (1) hour before the start of the preliminaries each day. Test scales should be available for the duration of the weigh-in so that the athletes can test their weight before they choose to go to the official weigh-in.

6.4.4 After Weigh-in Procedure

The Sport Director should be informed if an athlete does not pass the random weigh-in (either by not appearing within the time limit, failing the weight or failing to comply with the official's directions). The athlete will not be allowed to take part in the competition and the athlete's opponent will report to judogi control and go onto the tatami where they will be declared the winner by fusen-gachi and the WRL points will be given.

Senior and Junior Women		+ 5 % Tolerance
-48 kg	up to and including 48 kg	50.4 kg
-52 kg	over 48 kg up to and including 52 kg	54.6 kg
-57 kg	over 52 kg up to and including 57 kg	59.9 kg
-63 kg	over 57 kg up to and including 63 kg	66.2 kg
-70 kg	over 63 kg up to and including 70 kg	73.5 kg
-78 kg	over 70 kg up to and including 78 kg	81.9 kg
Senior and Junior Men		+ 5 % Tolerance
-60 kg	up to and including 60 kg	63 kg
-66 kg	over 60 kg up to and including 66 kg	69.3 kg
-73 kg	over 66 kg up to and including 73 kg	76.7 kg
-81 kg	over 73 kg up to and including 81 kg	85.1 kg
-90 kg	over 81 kg up to and including 90 kg	94.5 kg
-100 kg	over 90 kg up to and including 100 kg	105 kg
Cadet Women under 18 years		+ 5 % Tolerance + 0.1 kg allowed for underwear
-40 kg	up to and including 40 kg	42.1 kg
-44 kg	over 40 kg up to and including 44 kg	46.3 kg
-48 kg	over 44 kg up to and including 48 kg	50.5 kg
-52 kg	over 48 kg up to and including 52 kg	54.7 kg
-57 kg	over 52 kg up to and including 57 kg	60 kg
-63 kg	over 57 kg up to and including 63 kg	66.3 kg
-70 kg	over 63 kg up to and including 70 kg	73.6 kg
Cadet Men under 18 years		+ 5 % Tolerance + 0.1 kg allowed for underwear
-50 kg	up to and including 50 kg	52.6 kg
-55 kg	over 50 kg up to and including 55 kg	57.9 kg
-60 kg	over 55 kg up to and including 60 kg	63.1 kg
-66 kg	over 60 kg up to and including 66 kg	69.4 kg
-73 kg	over 66 kg up to and including 73 kg	76.8 kg
-81 kg	over 73 kg up to and including 81 kg	85.2 kg
-90 kg	over 81 kg up to and including 90 kg	94.6 kg



TBIL





EDUCATION AND COACHING

Education and Coaching is the responsibility of the IJF Education and Coaching Commission.

7.1 Coaches' Code of Conduct

Coaches must respect the Code of Ethics, statutes and regulations of the IJF. In the case of an infringement proven, penalties may range from a simple verbal warning to exclusion of competition.

The coach is responsible for their athletes' conduct from entering to the event until leaving it, in particular before and after each contest.

The coaches must make sure that their athletes follow the instructions of the organisers, the schedules and different protocols.

Coach positions is provided for each tatami and the coach must remain seated on the chair throughout the contest.

Coaching is authorised only during the pause after mate and before hajime. It is strictly limited to communication with his athlete, for tactical advice, encouragements and instructions.

If a coach gives indications during the contest, he receives a first warning. In case of repetition he will be excluded from the competition area. Any attitude contrary to the spirit of judo will be penalised.

If an accredited coach communicates from the tribunes, his accreditation will be withdrawn, and he will be suspended for the next IJF event.

The coach during the contest must not be in possession of a communication device. If this is the case, it will be excluded immediately from the competition area.

In the event that a coach is sanctioned by a referee, the Referee Director will inform the Director of Education for a sanction to be applied.

7.2 Coaches' Dress Code

Coaches must respect the following dress code:

- Draw: formal suit (jacket, trousers, shirt and tie for men; jacket, trousers/skirt/dress, blouse for women) and formal shoes.
- Preliminary rounds: national tracksuit with trousers reaching down to shoes. Coaches can wear national official short sleeved or long-sleeved T-shirts.
- For the final block program (TV time): formal suit (jacket, trousers, shirt and tie for men; jacket, trousers/skirt/dress, blouse for women) and formal shoes.

7.3 Contest Review Process

A delegate can request to review a contest at the end of the preliminaries or final block. A form, available from the person in charge of judogi control, must be completed and returned to judogi control. Only one coach can attend and may be accompanied by a translator.



COMPETITION VENUE

The competition venue is the responsibility of the IJF Sport Commission.

SECTION 8

8.1 Venue

The competition venue should be large enough to host the event and have adequate seating for spectators, VIPs, delegations and media. For the Olympic Games the seating capacity should be a minimum of 10,000. The venue should be well lit and of a constant temperature of between 18 – 22°C. Information for event organisers can be found in the IJF EOG.

8.2 Training Venue

The organising committee shall provide training areas and transport for all delegations. The training areas should be sufficient to accommodate the number of participants; it should be adequately ventilated and a temperature of 18 - 22°C maintained. Tatami used in the training venue should be approved by the IJF Head Sport Director. The tatami need to be placed on a resilient floor at ground level. If the floor is concrete, there should be Taraflex (or similar) underneath the tatami. The minimum height above the tatami must be 5 m.

During World Championships and Olympic Games training areas should be provided that are separate from the warm up area.

For Olympic Games and other large Multi-Sport events curtain or screen separation should be provided for privacy between the delegations with sufficient circulation space for coaches and support staff and benches for sitting.

Scales and medical provision must be provided. Additional facilities can include changing rooms with lockers, showers, saunas, fitness equipment and a lounge area with drinks and snacks.

Training times should be coordinated between the organising committee and the delegations.

8.3 Warm Up Area and Judogi Control

Check-in and judogi control are the responsibility of the IJF Education and Coaching Commission. The Commission must inform, by email, the IJF General Secretary of any cases where there is a breaching of the rules. The full IJF Judogi Rules can be found in Appendix C.

The warm up area must have the same rules as a dojo. Television cameras may film there so it should be kept tidy with NOTHING on the tatami except the competing athletes warming up. For other activities (eating, resting etc.) alternative spaces will be used. It is a shared space for all athletes to use. Delegations should not guard a space for their team.

If there is no other training venue those athletes competing the next day can train two (2) hours after the start of the competition.

Coaches are responsible for their delegation and must educate their athletes. If a delegation does not follow the rules ALL coaches from that delegation will have their accreditation removed for that day and if found coaching from the tribune will be subject to a disciplinary sanction.

There must be a warming up area(s) the size of which will be agreed by the IJF Sport Commission. Tatami used in the warm up area should respect the IJF tatami

rules (see 8.6). The tatami need to be placed on a resilient floor at ground level. If the floor is concrete, there should be Taraflex (or similar) underneath the mats. The minimum height above the mats must be 5 m. The main purpose of the tatami is for the athletes competing that day to warm up and there will be a strict nothing on the tatami policy. The Sport Commission will restrict warm up area access to those athletes that are competing that day. If there are no other training venue(s) then non-competing athletes will not be allowed to access the warm up area until two (2) hours after the start of the competition.

Screens showing the contest order and live contests should be available in both the warm up area and the judogi control areas so that coaches and athletes can always follow the competition.

A notice board should be placed in or near the warm up area so that information for the delegations can be displayed.

For the first contests of the day the athlete must be at the judogi control five (5) minutes before the official start time. If they do not arrive at the appointed time their coach will not be allowed to enter the field of play.

For the next rounds athletes must pass judogi control and be on time for their contests. If they do not arrive on time the 30 second rule will be applied (see Appendix D, Article 19). Athletes arriving during the 30 second countdown will not be allowed to have their coach accompany them onto field of play.

If any athlete is not able to continue in the competition the Sport Director must be informed immediately. The IJF Medical Commission delegate will verify the withdrawal if it is due to a medical reason.

8.4 Athlete Seating and Facilities

The athlete tribune, changing rooms, toilets and other facilities etc. should be as close as possible to the warm up area.

8.5 Entry to and Exit from Field of Play

The venue speaker(s) announce the players as they enter the field of play and the also the result of the contest. The athletes go onto the tatami on the side opposite that of the technical table. If the athletes walk from the left the first athlete called is the one in the blue judogi followed by white. If it is from the right the first athlete called is the one in the white judogi followed by blue.

In individual competitions an athlete can be accompanied onto the field of play with one coach and one doctor who must follow the dress code (for team competitions refer to section 2).

Athletes must enter and leave the field of play wearing their judogi in the proper way. It is not allowed to remove any part of the judogi or the belt **or to add items of clothing or accessories (caps, sunglasses etc.)** until the athlete has left both the field of play and the mixed zone. **The wearing of athlete prescription glasses in the field of play will be permitted but they must be removed before entering the tatami.**

If an athlete refuses to leave the tatami at the end of the contest, in serious cases both the athlete and the coach may be subject to a suspension of up to one year.

Religious, political, personal or commercial connotation is prohibited for everyone on the field of play.

8.6 Field of Play and Competition Area

A minimum of three entrances to the field of play are needed to run the competition and if there are less than this, it must be approved by the IJF Sport Commission. The contest areas are numbered from left to right from the side where the technical table is located.

Each competition tatami is divided into two zones: the contest area and the safety area. Each area is a different colour with sufficient contrast to avoid misleading edge situations. The IJF Sport Commission must agree the number of contest areas required. The contest area for IJF events shall be a minimum of 8 m x 8 m and a maximum of 10 m x 10 m. The safety area shall be a minimum of 3 m. Where two or more adjoining contest areas are used, a common safe zone may be used to satisfy the minimum distance of 4 m between them. A free zone of 50 cm minimum must be maintained around the entire competition area. Any requests to change the size of the contest and safety area must be approved by the IJF Head Sport Director.

All tatami for IJF events must be IJF approved (the list of official suppliers is available at www.ijf.org). Each tatami should measure 1 m x 2 m x 5 cm and be made of pressed foam. They must be firm under foot, have the property of absorbing shock during ukemi, and not be slippery or too rough. The tatami need to be placed on a resilient floor at ground level. The elements making up the floor surface must be aligned without space in between; the surface must be smooth and fixed in such a way that the individual mats cannot be displaced. If the floor is concrete, there should be Taraflex (or similar) underneath the mats. The minimum height above the tatami must be 12 m from the lowest hanging object.

The official tatami colours, for IJF WJT events, are yellow (123C) and red (1795C). Any other colours proposed by the local organising committee must be approved by the IJF before use. If a tatami needs to be changed, reserve tatami should be available close to the field of play.

For Masters, World Championships Seniors and Olympic Games, the contest area shall be 10 m x 10 m with a minimum common safety area of 4 m and a minimum exterior safety area of 4 m. This size is also recommended for Continental Championships.

Any decoration on the tatami, such as the host city name, year or event logos, can only be placed on the safety area, never on the contest area. This decoration should not be slippery.

The local organising committee must give the IJF all TV feeds for the refereeing CARE system, live streaming and TV archives. Refer to the EOG for further information.

For each competition area there shall be two (2) scoreboards that indicate the scores horizontally, placed outside the competition area where they can be easily seen by the competitors, referees, commission members, officials and spectators. Manual scoreboards, manual timers, bell or similar audio device and flags (yellow and green) must be available as backup.

When using several competition areas at the same time - the use of different audible signals is required. The time signal must be loud enough to be heard over the noise of the spectators.

For certain events e.g. Olympic Games the tatami may be placed on a solid platform. The platform must be made of wood or a similar material. It must be one metre wider and longer than the tatami dimensions. The height will depend on the sightlines in the sport hall. When using a platform, the exterior safety area must be 4 m.

8.7 Officials

All refereeing matters are the responsibility of the IJF Refereeing Commission. Refer to the IJF Refereeing Rules in Appendix D. A draw system is used for the referees to ensure neutrality and contest shall be conducted by one referee and two judges of different nationalities to the two competing athletes. One referee on the tatami with a radio communication system is connected to the IJF Supervisors and Referee Commission Members. Two technical officials are required per tatami for timing and scoring.

8.8 Medical

All medical matters are the responsibility of the IJF Medical Commission. Refer to the IJF Medical Handbook in Appendix E.

8.9 Media

All media matters are the responsibility of the IJF Media Director. It is expressly forbidden for all media including photographers to live stream at any time during the draw, competition or any other official IJF activity. Mobile devices must not be used for any function while mat side. Media are not allowed to access the warm-up area unless special access has been granted from the IJF. This must be proposed and granted by the IJF at least two weeks before the competition. Any member of the media who does not follow the above risks losing their accreditation and access to the competition.

8.10 Awarding Ceremonies

Each athlete who has won a medal must be present at the ceremony to receive their medal personally. The athlete should go to the awarding area immediately after their medal contest. Any athlete who is absent from the awards ceremony without a good reason may forfeit the medal and prize money.

Athletes must attend the medal ceremony barefoot, without any hat, cap or any similar head covering and wearing their IJF approved white judogi that conforms to the IJF judogi rules with special attention being paid to the publicity rule. If it is not clean, then they must wear a reserve judogi.

It is strictly prohibited for athletes on the podium to have a mobile phone (or similar device), national flags or similar items other than those on their judogi. Any demonstration with religious, political, personal or commercial connotation is also prohibited.

For each event the amount of prize money can be found in the outlines. For the prize money to be paid, each medallist must bring a copy of their passport and their

personal tax number to the awarding ceremony. Prize money will be given to the athletes who are then responsible to give 20% to their coach.

Athletes must also be available for interview after the last awarding ceremony if requested by the IJF Media Team. If they do not attend disciplinary action may be taken.

The flags should be hung from left to right - silver, gold, bronze A, bronze B. For a double hansoku-make in the final the flags should be hung silver A, silver B, no flag, bronze A, bronze B.

8.11 Delay, Postponement or Cancellation of a Competition

In the event of a delay (a competition has not started at its scheduled start time or is interrupted after the scheduled start) the competition will be restarted if it can be completed within the scheduled session or an extended session.

If there is a postponement (the competition which was underway cannot be completed within the scheduled session timings or in an extended session) or a cancellation (the competition cannot be rescheduled prior to the end of the event) the IJF Ad Hoc Commission will decide the best course of action.



REGULATIONS FOR VETERANS

The IJF Veterans Commission is responsible for all IJF veteran activities.

A1.1 Organisation

The Veteran Championships should be a sport festival, a sport competition and a social event. All rules are based on the IJF SOR, but there must be some tolerance towards those paying their own costs in order that they can still follow and support the sport of judo.

The championships will be held in June, September or October and will take place on a Friday, Saturday, and Sunday.

The championships will take place, as far as possible, in a resort or a city that is a tourist venue, as the IJF want to merge the judo event with a family and social event.

The venue should be large enough to accommodate four mats for a maximum of 800 competitors and a minimum of five mats for more than 800 competitors.

A1.2 Competition Rules for Veterans

The IJF competition rules will apply with the exception of modifications made to age divisions (section A4), category combining (section A7), contest and golden score duration (section A6) and judogi (section A11). A registered competitor can use their athlete accreditation to coach. An additional coach accreditation is not required.

A1.3 Eligibility to Participate

All the following conditions must be met in full for an individual to be considered eligible to participate in these Championships.

The minimum age for participation in the World Veterans is to be 30 years or over in the year of the event. This defines the age at which players first become eligible to compete. Once a player has become eligible, they will be allocated into their appropriate five-year age category i.e. M1/F1 will consist of competitors who have their 30th, 31st, 32nd, 33rd or 34th birthday and the M2/F2 will consist of players who have their 35th, 36th, 37th, 38th or 39th birthday at any date during the year of the World Championships.

- Hold a current and valid licence (membership) issued by a National Federation currently affiliated to the IJF.
- Pay the appropriate entry fees in full before the deadline set in the event outlines.
- Check in at registration (see schedule of Registration in the event outlines).
- Meet the specific weigh-in requirements.
- Provide photographic proof of their identity and date of birth using a valid current passport or a current national I.D. Card.
- A competitor must not have represented any national team in a competition at international senior level at any time in the twelve months' period before the start date of the particular World Veterans Championships.

The nationality of competitors will be taken as that which is indicated in their current passport or current national I.D. Card. Competitors may only represent one country, and in any cases of changing nationality, a one-year ineligibility period must be served prior to registration on site. In these circumstances, both National Federations involved must have already agreed and confirmed their agreement in writing conforming to the current IJF SOR regulations in section 1.8.

The appropriate documentation must be supplied with the application for competition entry.

- All players must have obtained the minimum grade of first kyu.
- Eligibility criteria from Section 4 will apply to veterans.

It is recommended that all competitors should have had a recent medical examination prior to participating in this championship.

A1.4 Age Divisions for Veterans

Players will be allocated an Age Division based on:

- Meeting the entrance criteria of a minimum of 30 years of age within the year of the event and,
- Their date of birth in line with a five-year age range:

Age division	Actual Age (in the year of the event)
F1/M1	30 -34
F2/M2	35 - 39
F3/M3	40 - 44
F4/M4	45 - 49
F5/M5	50 - 54
F6/M6	55 - 59
F7/M7	60 - 64
F8/M8	65 - 69
F9/M9	70 - 74
F10/M10	75 - 79
F11/M11	80 and over

In order to facilitate the best possible application of the category combining policy (section A1.7) in situations of potentially a small number of entries and all the female categories will be held on the same day.

A1.5 Weight Categories for Veterans

The weight categories are the same as those for senior men and women.

A1.6 Time Duration of Contests for Veterans

Duration (minutes) for individual events will be as follows:

- M1/F1 to M6/F6: three (3) minutes.
- M7/F7 and over: two and a half (2.5) minutes.

Age range	Age Division	Contest Duration	Golden Score
30-59	M1/F1 to/including M6/F6	3 minutes	No limit
60-79	M7/F7 to/including M10/F10	2.5 minutes	1 minute*

*If a tie exists at the end of the 1 minute golden score time, the referee, in consultation with the table jury will determine the winner without calling hantei.

A1.7 Category Combining for Veterans

A Technical Official from the IJF will delegate responsibility to a suitable individual, representing the Host Organisation, who will be responsible for operating the category combining policy. This policy applies to all weight categories within all age divisions.

Category combining may only be applied to categories where there are less than three entrants. If category combining cannot be achieved safely and according to the guidelines, then a pool of two elimination system may be considered. The best of three contests between the two players, if the result is 2-0 then the third contest will not be fought.

- Combining within the same age division - competitors should remain within their age division if possible.
- Combining using weight categories – competitors should only be combined with other competitors who are no more than one weight category lighter or one weight category heavier. Special consideration should be given to the actual weight differences when dealing with the lightest and the heaviest female and male categories (as a guideline a maximum of 10 kg actual difference when combining the lightest weight category and a maximum of 20 kg actual difference when combining the heaviest weight category should be considered as a limit unless there are other compensatory factors such as experience etc.). Weight should be the primary consideration when moving players about within their own age division or combining them with other age divisions in accordance with the guidelines below.

Age divisions:

- Competitors in age divisions M7 or F7 and above (for example M8/F8, M9/F9 etc.) may only be combined with other competitors who are no more than one age division higher or more than one age division lower i.e. competitors in M7/F7 may only be combined with competitors from M6/F6 or M8/F8.
- Competitors in divisions M6 or F6 may be combined with competitors no more than one age division higher or two age divisions lower. i.e. M7/F7, M5/F5 and M4/F4.
- Competitors in divisions M5 or F5 may be combined with competitors no more than one age division above or two age divisions below i.e. M6/F6, M4/F4 and M3/F3.
- Competitors in divisions M4 or F4 may be combined with competitors no more than two age divisions above or two age divisions below i.e. M5/F5, M6/F6, M3/F3 and M2/F2.
- Competitors in divisions M3 or F3 may be combined with competitors no more than two age divisions above or two age divisions below i.e. M4/F4, M5/F5, M1/F1 and M2/F2.
- Competitors in age divisions M2 or F2 may only be combined with competitors two age divisions above and one age division below i.e. M3/F3, M4/F4 and M1/F1.
- Competitors in age divisions M1 or F1 may only be combined with competitors in two age divisions above i.e. M2/F2 and M3/F3.

Age Division

M1/F1
 M2/F2
 M3/F3
 M4/F4
 M5/F5
 M6/F6
 M7/F7
 M8/F8
 M9/F9
 M10/F10
 M11/F11

Higher Age Division

M2/F2 M3/F3
 M3/F3 M4/F4
 M4/F4 M5/F5
 M5/F5 M6/F6
 M6/F6
 M7/F7
 M8/F8
 M9/F9
 M10/F10
 M11/F11
 M12/F12

Lower Age Division

Not applicable
 M1/F1
 M1/F1 M2/F2
 M2/F2 M3/F3
 M3/F3 M4/F4
 M4/F4 M5/F5
 M6/F6
 M7/F7
 M8/F8
 M9/F9
 M10/F10

A1.8 Draw for Veterans

The draw for the individual weight categories will take place at 19.00 hours on the day before the competition. Information on the exact location of the individual weight category draws will be displayed in registration.

A complete list of competitors who have successfully fulfilled the weight requirements will be displayed outside the room where the official draw will take place a minimum of 15 minutes prior to the draw starting.

Officials from each country should check this list to ensure that all their players are on the list who should be on the list, and that they have been correctly allocated to their age divisions and weight categories.

Only accredited officials will be entitled to attend the draw.

A1.9 Seeding for Veterans

In the veterans' event, there is no seeding, because competitors move into a new age category every five years and therefore enter in a new group of competitors.

A1.10 Weigh-in for Veterans

The weigh-in will take place the day before the competition as indicated in the outlines. There is no random weigh-in for veterans.

A1.11 Judogi Rules for Veterans

White and blue judogi are obligatory and all competitors must have both types. All judogi must conform to the current regulations regarding size, materials etc., but it is not required that a judogi is purchased from the currently selected IJF manufacturers list of suppliers.

A1.12 Backnumbers for Veterans

- Competitors must wear a back number on both their competition judogi jackets and these must be of the type currently recommended by the IJF or the host organisation.

A1.13 Competition System for Veterans

The type of competitions system to be applied in the competition will depend on the number of entries as follows:

Competition systems according to number of participants:

- 6 and more entries: double repechage
- 3, 4, 5 entries: round robin
- 2 entries: best of 2 contests, if 1-1 the third contest will decide.

In case the number of participants in a category is not sufficient, (age and/or weight) categories will be combine according to IJF SOR.

All the contests in any one age division will be held on the same day.

A1.14 Awarding of Medals for Veterans

Medals will only be awarded to competitors who have actually fought in the category. The number of players competing determines the eventual medal allocation.

The medal distribution rule is as follows:

- One player - no medal will be awarded (the competitor will receive a participation medal from IJF. There will be no flag, national anthem during this awarding ceremony)
- Two players – two medals awarded
- Three players – three medals will be awarded only if the third-place player has won at least one contest. In the case of no contest won there will only be two medals awarded
- Four players – three medals awarded
- Five players – three medals awarded
- Six or more players – four medals awarded

If a category has been combined the only medals awarded will be the one set of medals for the competitors in that combined category.



REGULATIONS FOR KATA

The IJF Kata Commission is responsible for all IJF kata activities.

B1.1 Eligibility to Participate

There are five officially recognised kata for the IJF Kata World Championships:

- Nage-no-kata.
- Katame-no-kata.
- Ju-no-kata.
- Kime-no-kata.
- Kodokan-goshin jutsu.

The IJF Kata Competition Rules will be used to judge the kata with reference also to the official Kodokan kata textbooks.

Each National Federation may enter in the competition a maximum of 10 pairs and a maximum of three (3) pairs in a kata per age category.

The pairs can be composed of two males, two females, or a male and a female.

For the U-23 age division both tori and uke will have to be under 23 years old and at least 16 years of age. They will have the possibility to perform up to two (2) kata, between Nage-no-kata and Katame-no-kata.

Senior division will be at least 16 years of age with no upper age limit. They will only have the opportunity to do one of the following kata: Nage-no-kata, Katame-no-kata, Ju-no-kata, Kodokan-goshin jutsu and Kime-no-kata.

Nationality - Refer to section 1.8. Competitors must have a minimum of 1st Dan and be at least 16 years of age on 1 January of the year in which the competition is organised; there is no upper age limit.

B1.2 Accreditation

The times and place for check-in and accreditation will be specified in the event outlines.

Number of accreditations for officials:

One – three (1-3) pairs: five (5) officials

Four – seven (4-7) pairs: 10 officials

B1.3 Draw

The draw to establish the groups and the sort of each group will be done the day before the competition. The pairs medallists from the previous world championships will be considered seeded and will be divided into two groups. The draw of the finals will be done in the Sports Hall after the preliminary rounds.

B1.4 Competition Formula

Each kata will be divided into two groups: the top three pairs with the maximum points from each group (that is six pairs for each kata) will compete in the finals. Three or four mats will be used for the preliminary rounds and three mats for the final. If the number of pairs is less than 10, there will be only one group: the top six pairs from the group will compete in the final. For each kata, the pair with the maximum points in the final will be awarded the gold medal, the pair with the second most points will be awarded the silver medal; and the third pair, the bronze medal.

B1.5 Judges and the System of Judging

The contests will be judged by IJF qualified kata judges. The number of judges per National Federation is limited to:

Participating countries may enter four (4) judges.

Non-participating countries may enter two (2) judges.

A judge cannot be a competitor.

The judges have to attend the technical meeting the afternoon before the first day of competition to confirm participation as judge in these championships. Time and place are stated in the event outlines.

There are five judges and they will award points on the official IJF scoring sheet. For each technique, the total score of three Judges will be totalled to produce the score for the technique: the maximum score and the minimum score for each technique will be cancelled. The final score of the whole Kata will be the sum of the score totalled by the judges for each technique.

The evaluation of every technique of Kata must consider the principle and the opportunity of execution: the evaluation (including the opening and closing ceremony) has to be comprehensive. In the nage-no-kata, right and left techniques will be evaluated comprehensively (only one score).

The five judges will be positioned on the shomen side and they will sit at about 1 m apart. The rule of neutrality will be applied so the judge must be of a different nationality than the competing pair. The position of the five judges will be the same throughout the competition. If a judge is temporarily replaced, he will take place in the same original position when he returns to the competition. The judges must take up their position before the arrival of the pair in the competition area.

The pair enters and leaves the competition area at the opposite side of shomen: the start and end of kata (opening and closing ceremony) is at an 8 m or 10 m distance apart depending on the dimension of the tatami (bow to the tatami). Any behaviour of tori or uke inside the competition area that is contrary to the spirit of kata will reduce the score of the ceremony.

In case of equal score between pairs, the following criteria will be applied considering the scoring sheets of five judges:

Total value of big mistakes - the pair who makes fewer mistakes wins.

If still equal, total value of medium mistakes will be considered - the pair who makes fewer mistakes wins.

If still equal, total value of small mistakes will be considered – the pair who makes fewer mistakes wins.

The pair who has the better score will win.

If two pairs, both placing 3rd in the eliminations (or 6th place in case of only 1 group) are still equal after all the above-mentioned criteria, both pairs will qualify for the final. If two pairs placing 1st, 2nd or 3rd during the final are still equal after the above-mentioned criteria, the kata will be repeated so that the medal can be assigned.

B1.6 Competition Area

The competition area dimension is 10 m x 10 m or 8 m x 8 m and shall be covered by tatami. A strip of visible coloured adhesive tape, approximately 5 cm wide and 50 cm long, shall be fixed on the centre of the competition area 6 m apart, to indicate the starting position of tori and uke. The centre of the competition area shall be indicated with a strip of adhesive tape of the same colour.



IJF JUDOGI RULES

Judogi control during IJF events is the responsibility of the IJF Education and Coaching Commission.

C1.1 IJF Approved Judogi

Competitors participating in IJF official events should comply with the IJF Judogi regulations. National Federations of the competing athletes are responsible for ensuring that the athletes are wearing approved IJF judogi that comply with the IJF judogi rules. The list of IJF approved judogi suppliers is available at <https://www.ijf.org/supplier-list>.

The judogi consists of a jacket and a pair of trousers and must be worn with a belt. The brand of both the jacket and trousers must be the same. Female competitors shall also wear a white T-shirt.

C1.1.1 Backnumber Control (refer to section 6.1)

Athletes have to bring both judogi (white and blue) for an unofficial control for the IJF official label (obligatory), judogi brand (obligatory), national emblem, advertising and backnumber. This service will start 30 minutes before the unofficial weigh-in. Only if the judogi are compliant with the IJF rules will sponsor labels be given.

If an athlete fails to show up for the judogi backnumber control the day before their competition, without a valid reason, the athlete will not be allowed to have a coach in the chair.

If an athlete does not have their judogi due to it being lost or stolen, on production of an airline (or train) lost baggage claim or a police report, reserve judogi will be given and the coach permitted to sit in the chair.

C1.1.2 Consequences of Failing Judogi Control

On each competition day the official judogi control will take place for each contest. Athletes and their coaches have to arrive together at judogi control. If the coach is not present for a valid reason (such as coaching another athlete at the same time) they will be allowed to join the athlete later. Athletes must arrive at judogi control wearing their judogi exactly as it should be to enter the tatami. Footwear is permitted at this point.

The markings of the logo, emblem and advertising etc. have to be made with a material that does not prevent good judo practice. It is not permitted to cover up/patch any part of the judogi or belt with tape, stickers or other material such as a sewn patch except under particular circumstances agreed by the IJF Executive Committee.

Note: In case an athlete wears a belt other than black, it has to be made of soft material and is exempt from having the IJF official label.

Following the contest order that shall be displayed in the judogi control area, the Education and Coaching Commission is responsible for calling the athletes to the judogi control area. The local organising committee must provide a public announcement system for this purpose. Athletes and their judogi shall be checked prior to each contest ensuring that they are in accordance with the IJF judogi rules. If the judogi does not comply with the current judogi rules the athlete will wear a reserve judogi and cannot have a coach in the chair.

The IJF Ad Hoc Commission will make a decision on the consequences for an athlete who deliberately avoids passing through judogi control and goes to the tatami.

C1.1.3 Judo Control Verification Positions

Control position 1 (see picture 11) - The athletes to be checked need to be in a standing position the arms must be straight put in front at chest height, palms open, fingers pointed upwards. Thumbs and forefingers of both hands should be in contact with each other to form a lozenge shape.

In this position the following will be controlled:

- The length of the sleeves.
- The distance between the arm and the sleeve.

Control position 2 - Athletes must be in a standing position with their arms straight down by the side of their body with open hands as close to the body as possible. If there is doubt, the official should ask the athletes if they are ready to be checked.

In this position the following will be controlled:

- The distance between the sternum top and the lapel crossing point of the jacket vertically.
- The length of the skirt.
- Length of the trousers.
- Distance between the leg and the trousers.
- Belt length.

C1.1.4 Judogi Control Procedure

1. Competitors' judogi must be dry, exempt from stains, must not show any worn-out signs, particularly on the collar and the lapel. If the condition of the judogi is assessed as unsatisfactory, the athlete must wear a spare judogi.

2. The "IJF Approved" label on the jacket, the trousers and the belt is controlled with a UV lamp.

3. The "IJF Official Supplier" logo of the judogi manufacturer must appear on the jacket, the trousers and the belt. The brand of the judogi manufacturer must be identical for the jacket and the trousers and the judogi should be of a uniform colour.

4. The name of the athlete on the accreditation card has to correspond with the name on the backnumber.

5. Only the national emblem can appear on the left-hand side of the jacket at chest level.

6. Control of the corresponding advertising, including the advertising reserved for the athlete.

7. Control of jacket, trousers (the malleolus must be visible and accessible for checking the length of the trousers) and belt size.

8. Control of any protections (knee pad, elbow pad, shin pad etc.). The protection cannot have any metallic/rigid parts. The control of the size of the judogi is done with the athlete wearing any protections.

9. Athletes can wear, from waist (below belt level) to knee length, underwear or shorts. It is forbidden to wear tights. Protective pads for the arms or legs level must be of soft material and not be visible.

10. Long hair must be tied up out of the way and not prevent the grip of the opponent.

In case the first judogi control is not conclusive, only one more control will be allowed.

C1.2 IJF Label

Each jacket and trousers must have an unforgeable optical label (see picture 1) which certifies that the judogi complies with the current IJF rules.



The label is fixed:

- On the bottom of the jacket, front left side, near or in the reinforced edge.
- On the top front side of the trousers, close to the centre.
- At one of the two edges of the belt.

One (1) possible location
Only one (1) logo allowed

Two (2) possible locations
Only one (1) logo allowed

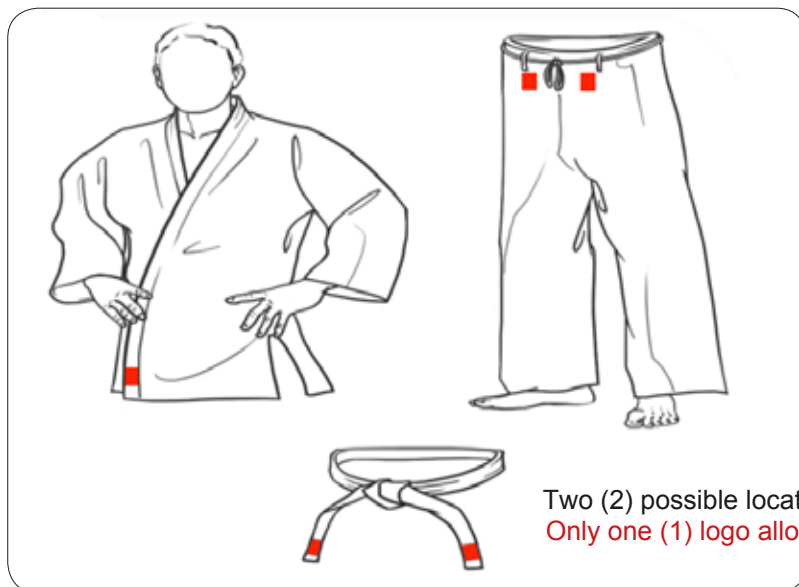

Picture 1 - IJF Label

C1.3 Location of the Manufacturer's Logo

Only one manufacturer's logo per clothing item is allowed (jacket, trousers, and belt). It must be a maximum 30 cm².

It should be fixed:

- On the jacket in a visible area either on the bottom, front left side, near or in the reinforced edge or at the bottom edge and inside the publicity zone (25 cm x 5 cm) permitted on the shoulders (see picture 2).

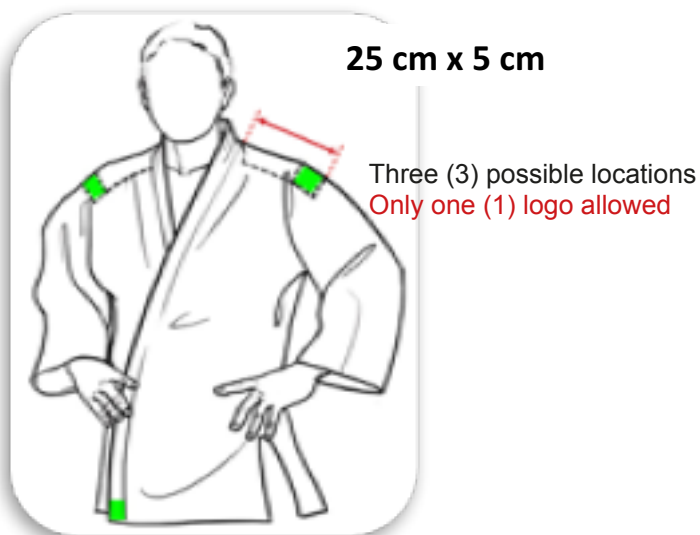

Picture 2 - Manufacturer's Logo

- On one of the two edges of the belt, in a visible area, maximum 9 cm² (see picture 3).



Picture 3 - Manufacturer's Logo

- On the trousers, in a visible area either at the top, at the front side or outside (maximum 20 cm from the waist string) or at the bottom, on one of the two trouser legs at the front side or outside, a maximum of 20 cm from the bottom of the lower edge of the trousers (see picture 4).

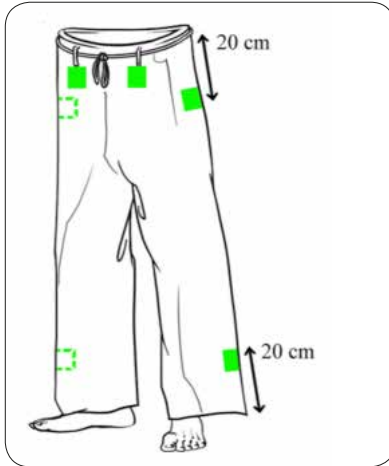

Six (6) possible locations
Only one (1) logo allowed

Picture 4 - Manufacturer's Logo

C1.4 National Emblem

This must be the official identification of a nation, a National Olympic Committee or an IJF affiliated National Federation. No commercial brand can be associated to it. It is fixed on the left-hand side, at the chest level (see picture 5) with a maximum surface of 100 cm². It can also appear in the publicity space (see picture 6).



One (1) possible location
Only one (1) emblem allowed

Picture 5 - National Emblem

C1.5 Advertising

Advertising is allowed only on the jacket. It must respect the practical provisions of IJF. The advertising cannot mention political, denominational or sport organisations other than the IJF, its Continental Unions, member National Federations, their organisations and affiliated clubs. On the visible part of the jacket the advertising can appear in 4 advertising spaces:

- On the sleeves, inside the surface of maximum 10 cm x 10 cm, situated at 25 cm from the lower part of the collar.
- On the shoulders, a stripe of 25 cm x 5 cm. The stripe must be calculated from the lower part of the collar down the sleeve.
- A maximum of 4 different publicities are permitted. Only one publicity is allowed per space.

Four (4) possible locations

10 cm x 10 cm

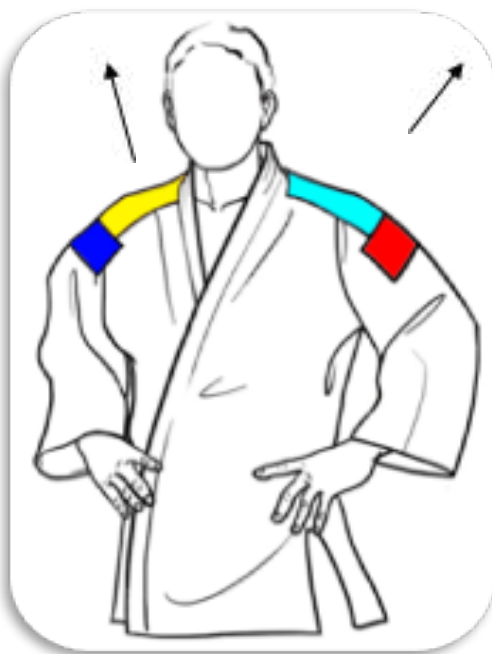

25 cm x 5 cm

Picture 6

C1.6 Additional Advertising Reserved for the Athlete

On the judogi jacket (right-hand side lapel only) there is an advertisement space reserved for the athlete (see picture 7). It must be a rectangle of 10 cm x 5 cm maximum, either a vertical or horizontal orientation is allowed.

Unless there is a specific agreement with the National Federation, the advertising cannot conflict with the brand of judogi that the athlete is wearing, the sponsors of the National Federation and if the sponsor of the National Federation has multi-activities, in the area concerned by the sponsorship.

This advertising shouldn't be an organisation that is in competition with the National Federation unless it is agreed with the National Federation.

It is not permitted, in the advertising spaces, to promote tobacco, alcohol, any prohibited substances listed in the Prohibited List of the World Antidoping Agency, or any product, goods or service contrary to morality or good ethics.

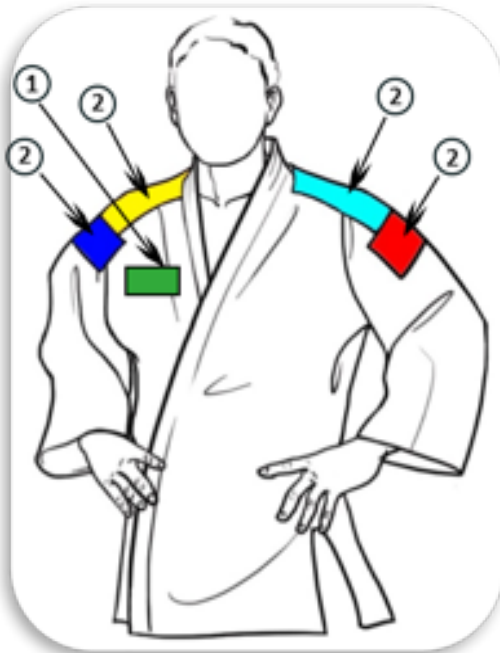

Picture 7

C1.7 Marking

The name of the athlete is permitted:

- On the bottom of the jacket (see picture 8 number 1)
- On the top of the trousers (see picture 8 number 2)
- On one of the two extremities of the belt (see picture 8.3)

The letters composing the name of the athlete should not exceed a height of 4 cm and a length of 20 cm. No other marking will be accepted.

Two (2) possible locations
Only one (1) text allowed

Four (4) possible locations
Only one (1) text allowed



Picture 8

Two (2) possible locations
Only one (1) text allowed

C1.8 Backnumber

Each competitor is obliged to have sewn on the back of his judogi a backnumber bearing their last (family) name and National Olympic Committee abbreviation (see picture 9). The last (family) name (and any part of their given (first) name) on the back number must have the same letters as that registered in judobase.org as this database provides the accreditation cards, athlete name on TV graphics and scoreboard etc. The back number can have a symbol on a letter, but the letters must be the same - for example:

In judobase Muller = back number Muller or Müller (letters match).

In judobase Weiss = back number Weiss but NOT Weiß (letters do not match).

Olympic champions are entitled to wear a gold backnumber and world champions a red one. The backnumber is provided by the IJF, world champions will receive four and Olympic champions will receive eight. This is valid only while the athlete is the current holder of the title and must be changed to the blue backnumber if the title is lost. One month will be allowed for the athlete to return to the blue backnumber. The backnumber should be stitched around the entire perimeter and the lower and upper edges should be crossed to form an X or alternatively six (6) straight

equidistant parallel horizontal lines can be stitched across. The backnumber needs to be clean and free from any stains or sticky residue (picture 9).

NOTE: On the pictures, the stitches are marked in red for a better understanding of how the sewing should be.

For Olympic Games and other Multi-Sport Games the sewing pattern will be specified the IJF Education and Coaching Commission.

The top of the backnumber must be fixed horizontally and centrally three (3) cm from the bottom of the collar. During the competitions organised by IJF, it must include the publicity of the competition (which is different for white and blue judogi).

Backnumbers must be ordered from the official IJF backnumber partner:

- www.officialbacknumber.com



Picture 9

C1.9 Judogi Colour

The jacket and the trousers should be of a uniform colour and correspond to the following colour references:

- White: Snow white reference.
- Blue: maximum pantone colour: 285M, minimum pantone colour: 286M.

C1.10 Judogi Size

The judogi and belt size is controlled by sokuteiki (see picture 10).

Picture 10



Jacket (see picture 11)

The “skirt” has to cover the buttocks completely.

With the arms level, the SOKUTEIKI must slip inside entirely and smoothly inside the sleeves. The judogi sleeves must cover up the full arm including wrist.

The width of the crossed distance of the jacket lapels at belt level must be at least 20 cm (see picture 12).

- The thickness of the lapel side must be less or equal to 1 cm.
- The width of the lapel side must be 4 cm.
- The distance between the sternum top and the lapel crossing point of the jacket vertically must be less than 10 cm.

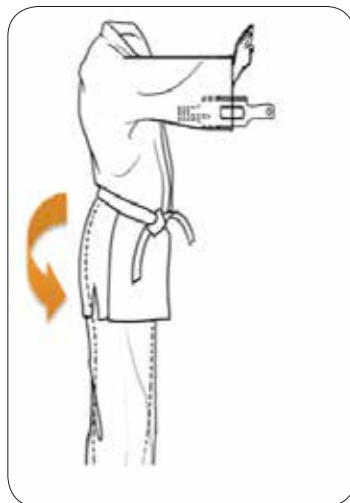

Picture 11

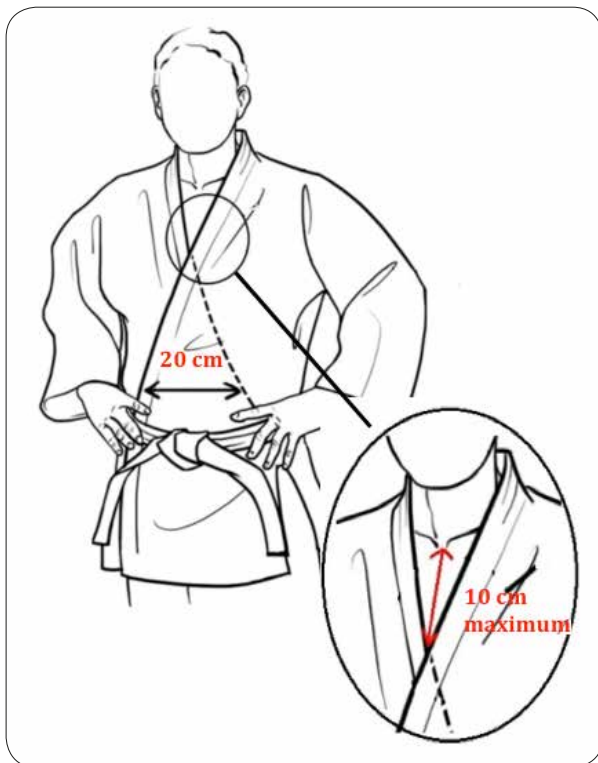

Picture 12

Trousers (see picture 13)

- The distance between the bottom of the trousers and the exterior malleolus (ankle bone) must be less or equal to 5 cm.
- The width must be between 10 and 15 cm at the knee level.

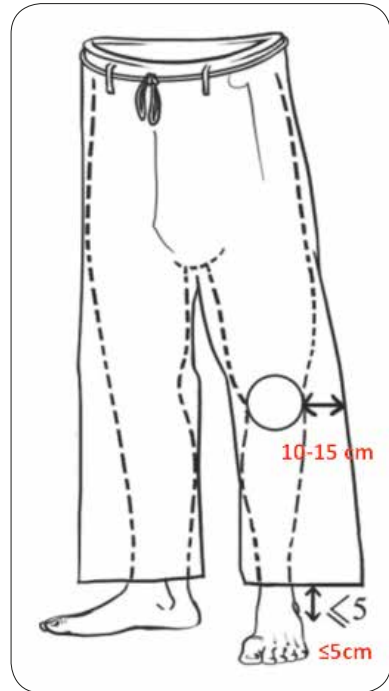

Picture 13

Belt (see picture 14)

- The thickness must be between 4 and 5 mm.
- The tips starting from the central knot must have a length between 20 and 30 cm.
- The belt must not be made of a stiff and/or slipping material and the knot must be correctly and tightly made.

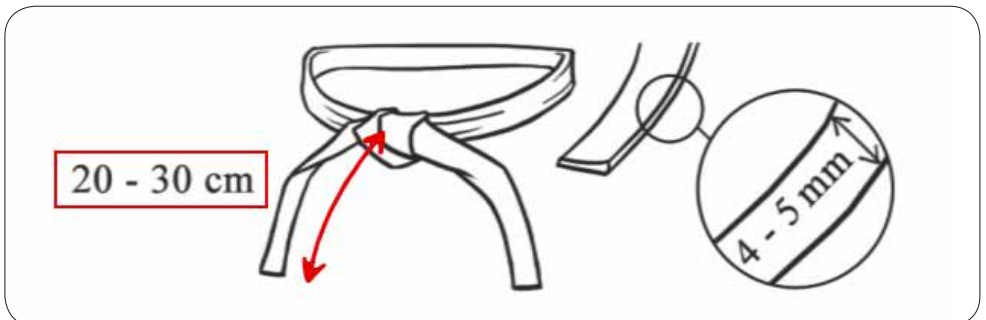

Picture 14

C1.11 T-shirt (for Women)

- White in colour (not transparent), short-sleeved and round-necked.
- Marking of the manufacturer logo, of maximum 30 cm² is authorised. It cannot be visible when the judogi is fastened.
- The national emblem representing the official identification of a nation, a National Olympic Committee or a member National Federation member of IJF, of a surface area of 100 cm² can be fixed on the chest, on the left side.
- No commercial marking can appear.

C1.12 Spare Judogi Supply

During the competitions organised by IJF, the organisers will supply spare belts, blue and white judogi of different sizes. Judogi will be available in the “call room” so that any change requirement could be met as quickly as possible. A closed structure for any changing requests must be located in the control zone.

The replacement judogi must be used only in the following cases:

- Torn judogi during a contest.
- Bloodstains or any other apparent stains.
- Irregular size.
- Irregular or missing backnumber.
- Inappropriate advertising.
- Inappropriate emblem.
- Unofficial brand.
- Jacket and trousers not the same brand.
- Inappropriate colour.
- Worn out judogi.
- Lost or stolen judogi.
- When the name on the backnumber is different from the one on the accreditation.

The judogi are supplied by the organisers for a contest. The competitor must leave his accreditation card and the part(s) of their judogi that do not comply with the rules with the organisers in exchange for the spare judogi. The spare judogi must be returned immediately after the contest it was used for. If a competitor refuses to comply with the rules, he will be excluded from the competition.

Note : The spare judogi are supplied for the competitors as a “service”. The organisers cannot be blamed if a competitor cannot find a judogi with a suitable size, whatsoever.

C1.13 National Technical Officials’ Duties

- Check athlete’s ID to correspond to the backnumber and check sponsor label (The backnumber and event sponsor label are compulsory).
- Check the ID which should be yellow of the accompanying coach. For preliminary rounds the coaches should wear a national tracksuit with trousers reaching down to shoes. They can wear national official short sleeved or long-sleeved T-shirts. For the final block, they must wear a formal suit (jacket, trousers, shirt and tie for men; jacket, trousers/skirt/dress, blouse for women) and formal shoes.
- The following are forbidden at any time: shorter trousers, undressed upper body, any kind of head caps and cover, jeans, sweaters or similar sports unrelated dress, flip- flops. In case a doctor appears with the athlete he should have an accreditation with the doctor’s symbol (a first aid kit box).

- Check the condition of the backnumber and sponsor label (it should not be torn off).
- Check judogi condition (should be dry, not torn or showing any blood stains).
- Check judogi colour (blue judogi should not look light blue).
- Check judogi brand (jacket, trousers and belt).
- Jacket and trousers should be of the same brand. The belt can be a different brand to that of the jacket and trousers.
- Check “IJF APPROVED” label with a UV lamp. The label should be red. The belt label can be red or blue. The logo of the judogi manufacturer must appear on the jacket, trousers and belt.
- Check belt ends length from central knot (between 20 cm and 30 cm).
- Check name of competitor on belt (allowed on one side only). The name of the athlete is not compulsory.
- Check name on jacket and trousers. One location allowed on each piece of competition clothing.
- Check length of the sleeves. They need to cover up the full arms including the wrists in the control position.
- Check the distance between the sternum top and the lapel crossing point of the jacket vertically. It must be less than 10 cm. The distance between the two lapels of the jacket at belt level, needs to be of a minimum of 20 cm.
- Check with a Sokuteiki the width of the sleeves, width of lapel, and length of trousers (the ankle bone, the malleolus, must be accessible for checking).
- Check length of the jacket (to cover the buttocks).
- Athletes can wear any underwear or leggings below the belt. These should not go below the knee, except if it is a separate protection made of soft material. The protection should not appear below the judogi trousers.
- Check for athletes’ advertisements to meet requirements.
- Check national emblem (100 cm²) on left side of the jacket).
- Female athletes must wear short sleeved white T-shirt (round necked). No visible advertisement should appear when judogi is done. Only logo of manufacturer (maximum 20 cm²) and national emblem can appear inside. No other marking allowed.
- If an athlete presents themselves with a tattoo mentioning political, religious or sporting bodies or promoting tobacco, alcohol, any prohibited substances listed in the Prohibited List of the World Antidoping Agency or any product, property or service contrary to good moral and ethical customs, it should to be covered with an adhesive bandage or medical tape.
- Verify the length of hand and foot nails and personal hygiene of the athlete. Long hair must be tied up with a non-metallic hair tie.
- Control any protective clothing (knee pad, elbow pad, shin pad etc.). No metallic part or any other part made of rigid material is allowed.
- Check that male athletes are not wearing any clothing under their jacket, on upper body.
- Ensure that the athlete is not carrying a prohibited object. This includes the holding or wearing of any electronic devices.
- Any head covering, jewellery or body piercings must be removed.

Note: For Multi-Sport events (e.g. Olympic Games, Youth Olympic Games etc.) there may be special judogi rules and these will be published separately and sent to all National Federations.

C1.14 World Champion and/or Olympic Champion Titles Enhancement

The International Judo federation gives the opportunity to athletes who are World and/or Olympic champions to enhance their title(s) with a marking on the judogi jacket at the level of the country's emblem (left side chest).

The World Champion title(s) is/are enhanced by a gold star, above the national emblem. The Olympic Champion title(s) is/are enhanced by a gold circle, below the national emblem.

C1.14.1 Procedure regarding World Champion title(s)

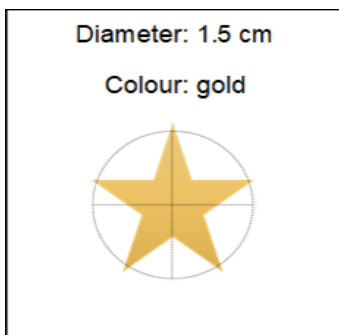

The star(s) are placed above the emblem. This symbol must not be in contact with a part of this emblem, plan a space between 0.5 cm and 2 cm. This symbol must be harmoniously placed in a circular arc, around the emblem in its upper part.

- Size: It must be in a 1.5 cm diameter circle.
- Colour: Gold.
- Positioning:
 - One star: at the centre.
 - Two stars: spaced from 1.5 cm to 2 cm beside the centre.
 - Three stars: one at the centre and 2 on each side.
 - Maximum 5 stars per line.
 - More than 5 stars: superimpose them with a space of 0.5 cm.
- Space between two stars: From 1.5 cm to 2 cm.

C1.1.4.2 Procedure regarding Olympic Champion title(s)

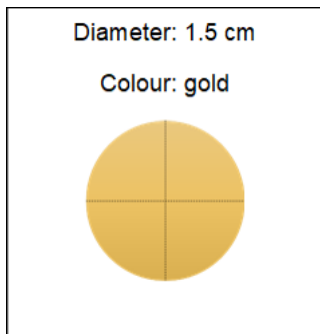

The circle(s) are placed below the emblem. This symbol must not be in contact with a part of this emblem, plan a space of 0.5 cm. This symbol must be harmoniously placed, in line below the national emblem in its lower part.

- Size: 1.5 cm diameter.
- Colour: Gold.
- Positioning:
 - One circle: at the centre.
 - Two circles: spaced from 1.5 cm to 2 cm beside the centre.
 - Three circles: one at the centre and 2 on each side.
- Space between the circles: From 1.5 cm to 2 cm.

Examples:





IJF REFEREEING RULES

All refereeing matters are the responsibility of the IJF Refereeing Commission.

APPENDIX D

D1.1 Refereeing - Culture, History and Principles

Jujitsu is the generic term that regroups all of the methods of empty hand combat that the warriors of the Japanese Middle Ages practiced.

The fierce fights between the various schools of jujitsu contributed to the notoriety of their masters and pupils; it was in general duels between the schools that opposed the best practitioner of each among them.

Jigoro Kano at the end of the 19th century developed a school of jujitsu, that he called "JUDO", different from the other "Ryu" by its target. Like the other schools, Judo cultivated the maximal efficiency, but the goal was not the same.

"The improvement of man and society "

Judo is a method of physical, intellectual and moral education, by the practice of a martial art.

Judo is the only martial art derived from Jujitsu where the grip of the opponent is obligatory; this is what gave its technical wealth, finesse and intelligence. The confrontation in jujitsu didn't allow real fighting since the goal was to kill without being killed oneself.

Jigoro Kano created a discipline where the confrontations allowed techniques to be applied completely, without ever injuring the opponent.

Ippon was granted only if the fall of the opponent was controlled until they hit the ground, or they submitted.

Apart from the elbow joint where one must leave the possibility for their adversary to quit, all techniques are executed in the sense of articulation and never in hyper extension.

The control of the fall direction, the impact and the speed of execution are the definition of the perfect success of the throwing technique.

Judo is not a struggle where one accumulates advantages or points, whether standing up or on the ground, judo is a duel with a code. The only goal is ippon; all other values can be counted only if there is a will to score Ippon.

The evolution of contests and refereeing through the years

Of the challenges inter-schools of jujitsu without mercy, one passed, a little more than 100 years later, to be a member discipline of the International Olympic Committee.

The competition is today extremely well regulated and fully corresponds to the "Olympic Charter" humanist, educational and social. Judo remains nevertheless a martial art where a 100% duel must be the rule. An accumulation of points doesn't give the victory, it is the perfect technique that is rewarded with an ippon that puts an end to the contest.

The only exception was "Waza-ari-awazete - ippon" where, in this case two techniques were executed and were evaluated as nearly Ippon. It is judged that they can correspond to "out of contest" (as at the time of the warriors of the Middle Ages) and counted in judo like "Ippon".

The refereeing must take into account the philosophical aspect of the duel between the two competitors and reward them by the correct value or the correct sanction.

The rewards are:

- Ippon or nearly Ippon (Waza-ari)

The sanctions are:

- A warning or disqualification, according to the severity, for those who put in danger their own health or that of their opponents, those who refuse to contest, those who stop the contest from taking place fairly, who comes out of the contest area. All actions contrary to the spirit of judo must also be punished.

The one who wins is the one who executed “THE” best technique or for “Hansoku-make” of the opponent (technical penalties or due to action against spirit of Judo).

Culturally and in complement, judo doesn't reduce itself to its Olympic expression, judo remains a martial art, judo is more than a sport, all the techniques of the Gokyo are part of the judo heritage and must always be taught.

It is the same for the “kappo”, techniques of resuscitations and joint mobilisations practiced about forty years ago by the judo teachers and the referees which are these days forbidden in some countries. Their practice is not allowed but their knowledge is part of the judo heritage and should under no circumstances be forgotten. Their practice isn't allowed for referees in IJF WJT competitions.

The referees are the guards of the physical, cultural and philosophical expression of Judo.

Judo must be understood to be appreciated

Article 1 - Referees and Officials

To referee at an IJF event a referee must hold an IJF international licence and be active in their nation and continent. The IJF Referee Commission will select the referees for the IJF events. The selection is based on:

The IJF referee ranking list.

The level of the event.

The period in which the event takes place (e.g. during or out of Olympic qualification).

The development stage of the referee.

Generally, the contest shall be conducted by three referees of different nationalities to the two competing athletes. For team competitions the same principle applies. In advance of the competition, before the weight category per mat distribution, the selected referees are allocated to a tatami. The assignment of the referees and judges to each contest is done using the IJF tournament software. The selection is done to guarantee nation neutrality and gives, in the long run, approximately the same number of assignments to be a referee on the mat and a judge on the technical table. After following these conditions, the selection done is completely random.

At each IJF WJT event there are 2 independent assessors whose sole function is to evaluate the referees based on their knowledge of the rules, their performance during each contest and the number of times corrections need to be made. The



best referees from the preliminaries, on that day, are selected for the final block. At the end of the competition each referee is given an evaluation (score). This score is then added to the IJF referee ranking list.

No one shall exercise the function of a referee during the events organised by the IJF or Continental Union if he holds the position of National Federation President, coach, doctor, official of the national team, National Refereeing Director and /or is responsible for the selection of the referees and of their evaluation; except National Federations Referee Directors can referee at cadet and junior continental cups and competitions excluding Continental Championships (IJF Executive Committee decision 17 January 2019).

The referees shall be assisted by technical officials who will operate the timing and scoring system and complete the competition paperwork.

The referee on the tatami has a radio communication system that is connected with the two judges on the technical table.

The IJF Supervisors and/or the IJF Refereeing Commission members who can possibly intervene, are sitting at their reserved places with their own CARE system. They are connected with the referee and the judges via headphones. The procedure is detailed in Article 13.6.

Article 2 - Position and Function of the Referee

Before officiating a contest, the referees should familiarise themselves with the sound of the gong or means of indicating the end of the contest on their particular tatami and with the position of the medical table. He should also check that his radio and headset are working. The referee has to ensure that the surface of the competition area is clean and in good condition and there are no gaps between the tatami. The referee should ensure that there are no spectators, supporters or photographers in a position to cause a nuisance or a risk of injury to the contestants.

The referee should ensure that all is in good order (e.g. competition area, equipment, uniforms, hygiene, technical officials etc.) before starting the contest.

The referee shall generally stay within the contest area. He shall conduct the contest and administer the decisions. He shall ensure that the decisions are correctly recorded.

In exceptional cases (e.g. when both contestants are in ne-waza and facing outwards) the referee may observe the action from the safety area.

The referee should leave the competition area during presentations or any lengthy delay in the programme.

The contestant wearing the blue judogi is to the left of the referee and the contestant wearing the white judogi is to the right of the referee.

Article 3 - Position and Function of the Judges

Two referees, acting as judges, will be seated at the technical table and will be refereeing together with the referee. They are connected by radios and will act according to the 'majority of three' rule.

Should a judge notice that the scoreboard is incorrect he should draw the referee's attention to the mistake and it should be corrected.

Should a contestant have to change any part of the judogi outside the competition area or need to temporarily leave the competition area after the contest has started for a reason considered necessary by the central referee, giving this authorisation only in exceptional circumstances, a judge must obligatorily go with the contestant to see that no anomaly occurs.

In case that the judges are not of the same gender, an official designated by the Refereeing Director shall substitute for the judges and accompany the contestant.

Article 4 – Gestures

The referee shall make gestures as indicated below when taking the following actions:

1. Ippon: shall raise one arm high above the head with the palm of the hand facing forward.
2. Waza-ari: shall raise one of his arms sideways to shoulder height with the palm of the hand facing downwards.
3. Waza-ari-awasete-ippou: first waza-ari, then the ippon gesture.
4. Osaekomi: shall point his arm, with the palm of the hand facing downwards, out from his body down towards the contestants while facing the contestants and bending his body towards them.
5. Toketa: shall raise one of his arms, with the fingers of the hand straight and forward and the thumb up, to the front and wave it from right to left quickly two or three times while bending his body towards the contestants.
6. Mate: shall raise one of his arms to shoulder height approximately parallel to the tatami and display the flattened palm of his hand (fingers up) to the timing and scoring technical officials.
7. Sono-mama: shall bend forward and touch both contestants with the palms of his hands.
8. Yoshi: shall firmly touch both contestants with the palms of his hands and bring pressure on them.
9. To indicate the cancellation of an expressed opinion: shall repeat with one hand the same gesture while raising the other hand above the head to the front and wave it from right to left two or three times. There should be no announcement made when cancelling an expressed opinion (score or penalty).

Should a rectification gesture be required, it shall be done as quickly as possible after the cancellation gesture.

If the situation allows, the referee will signal the cancellation when the fighters can see this gesture.

10. To indicate the winner of a contest: shall raise one hand, palm in, above shoulder height towards the winner.

11. To direct the contestant(s) to re-adjust the judogi: shall cross left hand over right, palms facing inwards, at belt height. To award a penalty towards the contestant who does not re-adjust their judogi correctly between the mate and the subsequent hajime: point towards the contestant (s) to be penalised with the forefinger extended from a closed fist while announcing the penalty and, then, cross left hand over right, palms facing inwards, at belt height.

12. To call the doctor: shall face the medical table, wave an arm (palm upwards) from the direction of medical table towards the injured contestant.

13. To award a penalty (shido or hansoku-make): shall point towards the contestant to be penalised with the forefinger extended from a closed fist.

14. Non-combativity: shall rotate, with a forward motion, the forearms at chest height then point with the forefinger at the contestant to be penalised.

15. False attack: shall extend both arms forward, with hands closed and then make a downward action with both hands.

16. Further gestures in case of penalties: they will be executed in compliance with the action to be sanctioned (see Article 18 - Prohibited Acts and Penalties).

When it is not clearly apparent, the referee may, after the official signal, point to the blue or white contestant (starting position) to indicate which contestant scored or was penalised.

To indicate to the contestant/s that he may sit cross-legged at the starting position if a lengthy delay in the contest is envisaged, the referee should signal towards the starting position with an open hand, palm upwards.

The waza-ari gesture should start with the arm across the chest, then sideways to the correct finishing position.

The waza-ari gestures should be maintained for three (3) to five (5) seconds while moving to ensure that the score is clearly visible to the judges. However, care should be taken when turning to keep the contestants within view.

Should both contestants be given a penalty, the referee should make the proper gesture and point alternately at both contestants (left forefinger for contestant on his left and right forefinger for contestant on his right).

To indicate the winner, the referee shall return to his position at start of the contest, take one step forward, indicate the winner and then take one step back.



Bow entering and leaving the tatami



Standing before the contest



Inviting the contestants onto the tatami



Ippon



Waza-ari



Waza-ari-awasete-ippon



Osaekomi



Toketa



Mate



Sono-mama \Leftrightarrow Yoshi



Stand up



To cancel expressed opinion



Not valid



Hajime
Sore-made



Kachi



To award a
penalty



Non combativity



False attack



To call the doctor



Penalty for a blocking attitude with two hands



Penalty for a blocking attitude with one hand



Penalty for cross gripping on one side



Penalty for refusing kumi-kata by covering lapel



Penalty for stepping out



Penalty for a pistol grip



Penalty for fingers inside sleeve



Penalty for not taking a grip



Penalty for leg grabbing



Fix judogi



Penalty for not fixing judogi

Article 5 - Location (Valid Areas)

The contest shall be fought in the contest area.

All actions are valid and may continue (no mate) as long as either contestant has some part of their body touching the contest area and the action started inside the contest area.

Any new technique applied when both contestants are outside the contest area shall not be recognized.

Exceptions

a) When a throw is started with only one contestant in contact with the contest area, but during the action both contestants move outside the contest area, the action may be considered for point scoring purposes if the throwing action continues uninterrupted.

Similarly, any immediate counter technique by the player who was not in contact with the contest area when the throwing action started inside, may be considered for point scoring purposes if the action continues uninterrupted.

b) Ne-waza action (aimed at osaekomi, kansetsu-waza or shime-waza) is valid and may continue outside of the contest area if it was started from inside.

The kansetsu-waza and shime-waza initiated inside the contest area and recognized as being effective to the opponent can be maintained, even if the contestants are outside the contest area, as long there is progression.

c) Ne-waza outside the contest area: if the throwing action is finished outside the competition area and immediately one of the players applies osaekomi, shime-waza or kansetsu-waza, this technique shall be valid as long there is progression.

If during ne-waza, outside the contest area, uke takes over the control with one of these nominated techniques in a continuous succession, it shall also be valid.

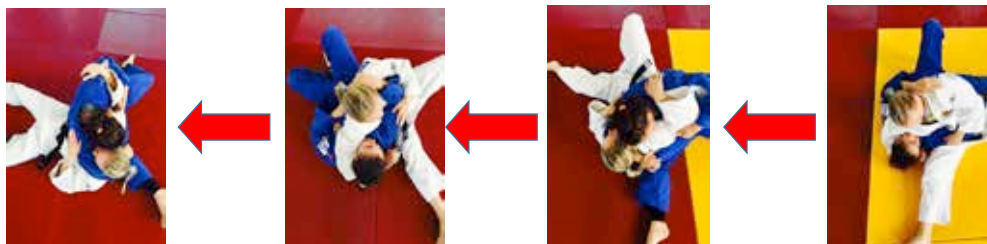

d) If during ne-waza outside the contest area the contestants go out of the safety area, this situation shall be dealt with and a decision given by the referees after consultation with the IJF Supervisors and/or IJF Refereeing Commission members.

Once the contest has started, if permission is given by the referee, the contestants can leave the competition area. Permission will only be given in very exceptional circumstances, such as the necessity to change a judogi or which has become damaged or soiled.

The same permission will be given in the case of an accident for which the doctor is required; this intervention will be done off of the tatami, near the area itself or close to the medical facility; the athlete will be accompanied by a judge or a referee not involved in the trio.

Article 6 - Duration of the Contest

1. The duration of the contests and the paperwork shall be determined according to the rules of the tournament.

For all IJF competitions the time duration of the contests will be:

Senior Men / Team:	4 minutes real contest time
Senior Women / Team:	4 minutes real contest time
Junior under 21 Men and Women /Team:	4 minutes real contest time
Cadet under 18 Men and Women / Team:	4 minutes real contest time

These times should be followed by National Federation for senior, junior and cadet competitions.

2. Any contestant is entitled to a 10 minutes rest between contests.

Article 7 - Osaekomi Time

- a) Ippon: 20 seconds.
- b) Waza-ari: 10 seconds or more but less than 20 seconds.

Article 8 - Technique Coinciding with the Time Signal

1. Any immediate result of a technique started simultaneously with the time signal shall be valid.

2. Although a throwing technique may be applied simultaneously with the bell, if the referee and the judges or the IJF Supervisors and/or the IJF Refereeing Commission members decide that it will not be effective immediately, the referee shall announce sore-made, without any value for scoring purposes.

3. Any technique applied after the ringing of the bell to indicate the expiry of the time of the contest shall not be valid, even if the referee has not yet announced sore-made.

4. Simultaneous osaekomi with the time signal: when osaekomi is announced simultaneously with the bell or similar audible device indicating the time signal allotted for the contest or when the remaining time is insufficient to allow for the completion of the osaekomi, the time allotted for the contest shall be extended until either ippon (or equivalence) is announced or the referee announces sore-made.

During that time the contestant who receives the osaekomi (uke) can counterattack by applying shime-waza or kansetsu-waza. In case of getting a give up or incapacity of the contestant making the osaekomi (tori), the one who's under osaekomi (uke) will win the contest by ippon.

Article 9 - Start of the Contest

1. The referee and the judges shall always be in position to start the contest before the arrival on the contest area of the contestants.

In individual competition the referee shall be at the tatami centre 2 m back from the line from which the contestants start and shall be facing the timekeepers' table and the judges will be seated at their respective table.

In team competitions, before the start of the contests from every encounter, it shall proceed to the bowing ceremony between the two teams as follows:

- a) The referee will remain in the same place as in the individual competitions. At his indication, the two teams will come in on the side allotted, in line for the outer edge of contest area, in descending order and the heaviest weight being closer to the referee, standing face-to-face team.
- b) On the order of the referee the two (2) teams will move ahead to the starting position on the mat.
- c) The referee shall order the teams turn towards the technical table, extending his arms in parallel forward, with open palms, and will announce rei, to be held simultaneously by all components of both teams. The referee shall not bow.
- d) Then the referee shall order, in a gesture of arms at right angles forearms up and palms facing each other "otagai-ni" (bow to each other), the two teams again be face to face, announcing rei, to be held the same way as in the previous section.
- e) After finishing the bowing ceremony, the components of the two teams will come out through the same place which they entered, waiting, on the outer edge centred of the contest area, the contestants of each team must make the first contest. In each contest, they will perform the same procedure of bowing that in individual competition.
- f) After finishing the last contest of the encounter, the referee will order the teams to proceed as described in paragraph a) and b), announcing, then the winner. The bowing ceremony will be held in the reverse - order of the start, bowing first to each other and, finally, to the technical table.

2. The contestants are free to bow when entering or leaving the contest area, although it is not compulsory.

When entering the tatami area, athletes should walk to the entrance of the contest area at the same time.

The contestants must NOT shake hands before the start of the contest.

3. The contestants shall then walk to the centre of the edge of the contest area (on the safety area) at their respective side according the fighting order (judoka in the white judogi on the right side and judoka in the blue judogi on the left side of the referee's position) and remain standing there.

At the signal from the referee, the contestants shall move forward to their respective starting positions and bow simultaneously towards each other and take a step forward from the left foot.

Once the contest is over and the referee has awarded the result, the contestants shall simultaneously take a step back from the right foot and bow to each other.

If the contestants do not bow or do so incorrectly, the referee shall direct the contestants to do so. It is very important to perform the bow in a very correct way.

4. The contest always starts with the athletes in the standing position, wearing their judogi correctly with the belt tied tightly above their hip bones, then the referee announces hajime.

During the contest the judoka should always fix their judogi quickly between “mate” and “hajime”.

5. The accredited doctor may request that the referee stops the contest in the cases and with the consequences regulated in Article 20.

6. The IJF Supervisors and/or the IJF Refereeing Commission members may interrupt the contest and will interfere only when there is a mistake that needs to be rectified.

The intervention and any change to the decisions of the referees by the IJF Supervisors and/or the IJF Refereeing Commission members will be made only in exceptional circumstances.

The interventions of the IJF Supervisors and/or the IJF Refereeing Commission members should take place in three (3) cases:

- A mistake of awarding the action between the white and the blue competitor.
- On the awarding of hansoku-make for actions contrary to the spirit of judo or which may have further consequences for the athlete who has committed them.
- Exceptional cases.

There is no appeal procedure for coaches, but they can, after submitting a “request of coach to review a contest on video by IJF Supervisors and/or the IJF Refereeing Commission members”, at the end of the session, to watch the reason for the change to the final decision.

Article 10 - Transition from Tachi-waza into Ne-waza (A) and from Ne-waza into Tachi-waza (B)

It is considered to be tachi-waza when both athletes are in a standing position and are not in any of the following ne-waza positions.

Both athletes must have two knees on the floor, for it to be considered ne-waza (picture 1). If there is a loss of contact between the athletes and there is no possibility of continuation, mate must be called (picture 2). Lying on the stomach on the ground, the blue athlete is considered to be in ne-waza (picture 3). Grip control from the standing athlete (white), we still consider the athlete (blue) on the knees to be in tachi-waza and consequently tachi-waza regulations would be applied (picture 4). However, if white does not attack immediately, then the referee must

call mate! The kneeling athlete (blue) on cannot grab the legs to defend the throw with his arms, if this happens, shido will be given.



1

2

3

4

In this position (below) the blue athlete can touch the leg. A throw (by white or blue) from this position cannot be considered for a score.

If the blue athlete has two elbows and two knees on the floor, the white athlete can do a technique but **ONLY** to transition into ne-waza.



In this position (below) the white athlete can throw his opponent, but the attack must be done immediately.





1



2



3



4



5



1



2



3



4

Grip control from standing athlete (white). The athlete on his knees (blue) in tachi-waza so tachi-waza rules will be applied. If the white athlete does not attack immediately the referee must call mate!

In this position (below) the athlete on the knees (blue) cannot grab the legs with the hands/arms to defend the throw. If this happens, shido will be given.



A1. The contestants shall be able to change from nage-waza to ne-waza as far as it is done by one of the cases referred to in this Article. However, if the technique used is not continuous, the referee shall announce mate and order both contestants to resume the contest from the standing position.

A1. Exceptions

Situations that are not allowed during tachi-waza

a) To apply kansetu-waza or shime-waza (alone or combined with a judo throwing technique) when both athletes are in a standing position or move with this technique from tachi-waza to newaza (See Article 18).

A2. Situations that allow the transition from tachi-waza to ne-waza

a) When one of the contestants, lands on the ground and there is no score or waza-ari is given, either contestant can, without interruption, take the offensive and continue in ne-waza.

Example: in this position tori can apply sutemi-waza that can continue into ne-waza.



Example: in this position tori can apply a throwing technique and can continue with kansetsu-waza, shime-waza or osaekomi-waza (not shown).



b) When one contestant takes his opponent down into ne-waza by the particularly skilful application of a movement which does not qualify as a throwing technique.

c) In any other case where one contestant falls down or is about to fall down, not covered by the preceding sub-sections of this article, the other contestant may take advantage of his opponent's unbalanced position to go into ne-waza.

A2. Exceptions

When one contestant pulls his opponent down into ne-waza not in accordance with the above rules and his opponent does not take advantage of this to continue into ne-waza, the referee shall announce mate, and penalise with shido the contestant who has infringed Article 18. If instead, the opponent takes advantage of the action of tori, the ne-waza work may continue.

B1. The contestants shall be able to change from ne-waza to tachi-waza as far as it is done by the case below. However, if the technique used is not continuous, the referee shall announce mate and order both contestants to resume the contest from the standing position.

B2. The situation is not dangerous for both athletes with or without grips and both athletes are more or less face to face.

The kata-sankaku grip in ne-waza action is allowed (picture 1). It is prohibited to block the opponents body with the legs and must be mate (picture 2). If the kata-sankaku grip is used in tachi-waza mate will be called (picture 3).



1



2



3

Article 11 - Application of Mate

1. General

The referee shall announce mate in order to stop the contest temporarily in the situations covered by this article. To recommence the contest, the referee shall announce hajime.

The contestants must quickly return after mate to their starting positions in the following cases:

- The referee will give shido for stepping outside.
- The referee will give a third (3rd) shido - hansoku-make.
- The referee will ask the contestants to adjust their judogi.
- The referee is of the opinion that a contestant(s) requires medical attention.

When a mate must be given for a shido to the athlete deserving it, contestants will remain in place, without having to return to the starting position (mate – shido – hajime).

The referee having announced mate, must take care to maintain the contestants within his view in case they did not hear the announcement and continue fighting or if any other incident arises.

2. Situations where the referee shall announce mate:

a) When both contestants go completely outside the contest area without continuous action that started from inside the contest area.

b) When one or both of the contestants perform one of the prohibited acts listed in Article 18 of these rules.

c) When one or both of the competitors are injured or taken ill. Should any of the situations of Article 20 occur, the referee, after announcing mate, shall call the doctor to perform the necessary medical attention according to said article, either upon the request of the contestant, or directly depending on the seriousness of the injury. In cases of “minor” injury, the medical intervention will be carried out outside the contest area, near the area itself or close to the medical facility; the Athlete will be accompanied by a judge or referee not involved in the trio.

d) When it is necessary for one or both of the contestants to adjust their judogi.

e) When during ne-waza there is no evident progress.

f) When one contestant regains a standing or semi-standing position from ne-waza bearing his opponent on his back, with the hands completely clear of the tatami and without his opponent being able to progress the action.

g) When one contestant in, or from ne-waza regains a standing position and lifts the opponent, who is lying on their back with one (1) or both legs around any part of the standing contestant, clear of the tatami.

h) When a contestant performs or attempts to perform kansetsu-waza or shime-waza from the standing position.

i) When one of the contestants starts or perform any preparatory moves of a kind of fighting or wrestling technique (not genuine judo) the referee shall call immediately mate, trying to stop and not to let the contestant who performs, finishes the action.

j) When tori applies shime-waza or kansetsu-waza by stretching uke's leg.

k) When in any other case that the referee deems it necessary to do so.

3. Situations where the referee shall not announce mate:

a) To stop the contestant(s) going outside the contest area unless the situation is considered dangerous.

b) When there is a throwing that started inside the contest area and both judoka continue to go outside as part of the action.

c) When a contestant, who has escaped from osaekomi-waza, shime-waza or kansetsu-waza, appears in need of or calls for a rest.

These are valid actions and mate should not be called.

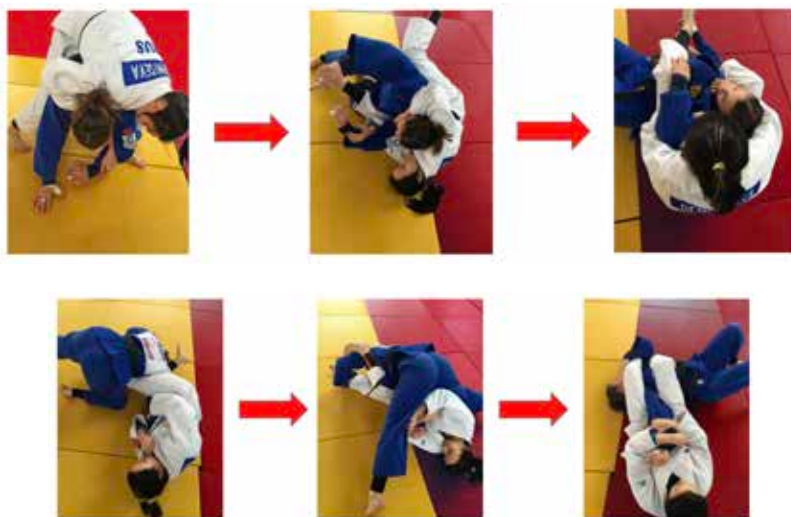

Mate should not be given as the action started in the valid area.

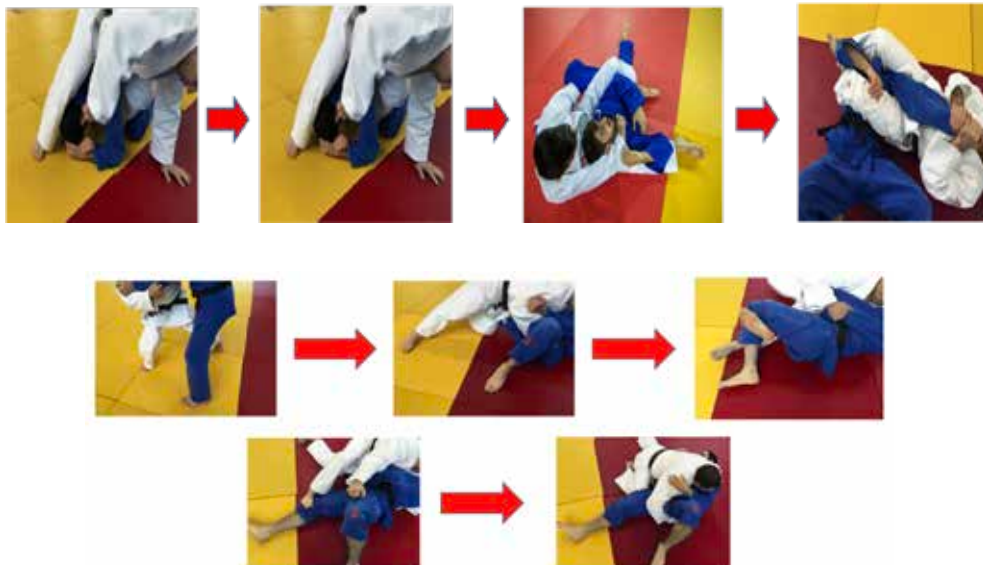

Article 12 – Sono-mama

1. Sono-mama can only be applied in situations where contestants are working in ne-waza.
2. In any case where the referee wishes to temporarily stop the contest without causing a change in their positions, he/she shall announce sono-mama, making the gesture under Article 4.7 while he must ensure that there is no change in the position or grip of either contestant.
3. To recommence the contest, the referee shall announce yoshi making the gesture under Article 4.8.

Article 13 - End of the Contest

1. In regular time (4 minutes), a contest can only be won by a technical score or scores (waza-ari or ippon).

A penalty or penalties will not decide the winner, except for hansoku-make (direct or accumulative). A penalty never corresponds to a score. The referee shall announce sore-made to indicate the end of contest in the cases covered in this article. After this announcement the referee shall always keep the contestants within his view in case they do not hear his announcement and continue fighting. The referee shall direct the contestants to adjust their judogi, if necessary, prior to indicating the result.

After the referee has indicated the result of the contest making the gesture under Article 4, the contestants shall take one step backwards, make the bow and leave the contest area by the sides of the mat, particularly around the security area.

When the athletes are leaving the mat, they must be wearing their judogi in the proper way and must not remove any part of the judogi or the belt before leaving the field of play.

Should the referee award the victory to the wrong contestant in error, the judges must ensure that he changes this erroneous decision before the referee leave the competition area; if this doesn't happen the IJF Supervisors and/or the Refereeing Commission members can intervene to solve this mistake.

All actions and decisions taken in accordance with the "majority of three" rule by the referees and agreed by the IJF Supervisors and/or Refereeing Commission members shall be final and without appeal.

2. Situations of sore-made:

- a) When one contestant scores ippon or waza-ari-awasete-ippon (Articles 15 & 16).
- b) In the case of kiken-gachi (Article 19).
- c) In the case of hansoku-make (Article 18).
- d) When one contestant cannot continue due to injury (Article 20).
- e) When the time allotted for the contest has expired.
- f) Waza-ari from a throwing action in golden score.

3. The referee shall award the contest as follows:

- a) When one contestant has scored ippon or equivalent, he shall be declared the winner.
- b) When both players have no technical score, or the technical scores are equal at the end of the regular contest time, the contest shall continue in golden score regardless number of shido given.

4. Golden score period

In individual and team competitions when contest time ends with the circumstances of paragraph 3b. of this article, the referee shall announce "sore-made" to end the contest temporarily and the contestants shall return to their starting positions.

The referee shall announce "hajime" to restart the contest. There shall be no rest period between the end of the original contest and the start of golden score.

There is no time limit for golden score. Any existing score(s) and/or numbers of shido from regular time are carried into the golden score period and will remain on the score board.

Golden score can only be won by a technical score (waza-ari or ippon) or hansoku-make (direct or by accumulative shido). If direct hansoku-make is given, the consequences are the same as those in regular time.

The referee will then announce sore-made.

In the golden score period osaekomi is going until the end (20 seconds). When one contestant is being held down and osaekomi has been announced, the referee



shall allow the hold down to continue as long as possible (giving the athlete the opportunity to score ippon) or until toketa, mate or until shime-waza/ kansetsu-waza is applied by either contestant with immediate result.

However, if the hold is broken before ippon is scored but waza-ari has been scored the contest will be finished and the winner declared.

5. Special situations during golden score.

a) Should only one contestant exercise his right to participate in the “golden score” period, and the other contestant declines, the contestant who wishes to compete shall be declared the winner by “kiken-gachi”.

b) In the case where both contestants score ippon simultaneously during the time allotted for regular time, the contest shall be decided by a “golden score” period. In the case of simultaneous ippon during the “golden score” period the referee shall announce mate, continuing the contest without taking into account these actions for scoring purposes.

c) For direct hansoku-make given to both contestants, the IJF Ad Hoc Commission will decide.

6. CARE system

Viewing of the CARE system and subsequent communication with the referees as regulated in this article shall be up to the discretion of the IJF Supervisors and/or IJF Refereeing Commission Members that oversee the mat. The IJF Supervisors are responsible for all rules and decisions during the contest. In exceptional circumstances the decision will be made by the IJF Supervisors and IJF Refereeing Commission Members.

Supervisors with the collaboration of the IJF Head Referee Directors must intervene in extreme circumstances and let the referees do their work in accordance with the rule of the “majority of the three”. The intervention must be immediate without loss of time or hesitation as follows: immediately all agree, the decision is validated or corrected; the situation is not clear and there is no unanimity, no intervention is carried out (hajime).

Mandatory reviewing using the CARE system in support of the decision on the mat will be done under the following circumstances:

1) Any decision involving the end of the contest, during the contest time as well as in the period of “golden score”.

2) In a kaeshi-waza situation: the judoka receiving the attack and starting the counter attack, CANNOT use the impact of landing on the tatami to finish his kaeshi-waza action and have it evaluated. If the action allows it, he can however continue in ne-waza:

- If the two athletes land together without clear control for either one, no score will be given.
- Any action after landing will be considered as a ne-waza action.

There shall be no unauthorised use or request of use of the CARE system other than by the IJF Supervisors and/or Refereeing Commission members.



Article 14 – Ippon

Evaluation of the points in nage-waza.

The four criteria for ippon are speed, force, on the back and skilfully controlled until the end of the landing.

1. Ippon will be given when the contestant throws his opponent on the back, applying a technique or countering his opponent's attacking technique, with considerable ability with maximum efficiency (*).

* "ikioi" = momentum with both force and speed and "hazumi" = skilfulness with impetus, sharpness or rhythm.

Rolling can be considered ippon only if there is no break during landing. The difference of the rolling makes the evaluation of the points. It is Ippon when uke rolls on his back.



2. All situations in which one of the contestants deliberately makes a "bridge" (head and one foot or both feet in contact with the tatami) after having been thrown will be considered ippon.



This decision is taken for the safety of the contestants, so they do not try to escape from the technique and endanger their cervical spine. Also, an attempt of a bridge (arching the body) should be counted as a "bridge".

No score or penalty will be given if the landing of uke occurs on the body of tori, in such a way that not all parts of uke's body involving the bridge situation (head, foot or feet) touch the tatami.

Evaluation of the points in ne-waza

a) When a contestant holds with osaekomi-waza the other contestant, who is unable to get away for 20 seconds after the announcement of osaekomi.

b) When a contestant gives up by tapping twice (2) or more with his hand or foot or says maitta (I give up!) generally as a result of osaekomi-waza, shime-waza or kansetsu-waza.

c) When a contestant is incapacitated by the effect of a shime-waza or kansetsu-waza.

Should one contestant be penalised with hansoku-make, the other contestant shall immediately be declared the winner with a score equivalent to ippon.

Special situations

a) Simultaneous techniques - when both contestants fall to the tatami after what appears to be simultaneous attacks and the referees cannot decide which technique dominated there should be no score awarded.

b) In the case where both contestants score simultaneous ippon the referee will act as regulated in article 13 paragraph 5.b.

Article 15 - Waza-ari

Evaluation of the points in nage-waza. The referee shall announce waza-ari when in his opinion the applied technique corresponds to the following criteria:

- When the four ippon criteria are not fully achieved.

These landings are considered to be waza-ari.



In order not to give a bad example for young judokas, landing on both elbows or two hands or one elbow and one hand is considered valid and should be evaluated with waza-ari.



- Landing only on one elbow cannot be used for assessment.
- Landing on the side of the upper body should be evaluated with waza-ari.
- Landing on one elbow, on the bottom or the knee with immediately continuation on the back will be waza-ari.
- Rolling can be considered waza-ari if there is a break during landing. The difference of the rolling makes the evaluation of the points it is waza-ari when uke rolls on his side or hips.
- Two waza-ari are the equivalent of one ippon (waza-ari-awasete-ippon) and the contest will be finished (Article 16).



These landings are not considered to be waza-ari.



Evaluation of the points in osaekomi-waza.

a) When a contestant holds with osaekomi-waza the other contestant who is unable to get away for 10 seconds or more, but less than 20 seconds.

Article 16 - Waza-ari-awasete-ippon

Should one contestant gain a second waza-ari in the contest, the referee shall announce waza-ari-awasete-ippon.

Article 17 - Osaekomi-waza

Evaluation of ippon in osaekomi-waza is given when a contestant holds the other contestant who is unable to get away for 20 seconds, waza-ari is given for 10 seconds or more but less than 20 seconds.

The referee shall announce osaekomi for an applied technique when the contestant being held is controlled from every direction (from the side, rear or on top) by his opponent and must have his full back or complete upper back (scapular region) in contact with the tatami. The contestant applying the hold must not have his leg(s) or body controlled by his opponent's legs. The contestant applying osaekomi must have his body on and over opponent's body in covering it to hold opponent down underneath his body, with applying pressure onto opponent's front upper body with his front upper body in either the kesa, the shiho or ura position, i.e. similar to the techniques kesa-kami-shiho-ura-gatame and sankaku-waza.

Should a contestant who is controlling his opponent with an osaekomi-waza, changed without losing control, into another osaekomi-waza, the osaekomi time will continue until the announcement of ippon (or equivalence), toketa or mate.

When osaekomi is being applied and tori commits an infringement meriting a penalty (shido):

If the osaekomi time is less than 10 seconds, the referee shall announce mate, return the contestants to their standing positions, award the penalty then recommence the contest by announcing hajime.

If the osaekomi time is 10 seconds or more, but less than 20 seconds, the referee shall announce mate, return the contestants to their standing positions, award the contestant who was in an advantageous position with the penalty (shido) and the score (waza-ari); then recommence the contest by announcing hajime.

However, should the penalty to be awarded be hansoku-make, the referee shall, after announcing sono-mama, consult with the judges, announce mate to return the contestants to their starting positions, then award hansoku-make and end the contest by announcing sore-made.

When osaekomi is being applied and uke commits an infringement meriting a penalty, the referee shall announce sono-mama, award the penalty, then recommence the contest by touching both contestants and announcing yoshi.

When the situation permits and in order not to interrupt the positive action of tori, the referee will award directly the penalty pointing uke without interrupting the contest with sono-mama.

However, should the penalty to be awarded be hansoku-make, the referee shall, after announcing sono-mama, consult with the judges, announce mate to return the contestants to their starting positions, then award hansoku-make and end the contest by announcing sore-made.

If both table judges agree that an osaekomi exists, but the referee has not announced osaekomi, they shall inform the referee and by the “majority of three” rule, the referee shall announce osaekomi immediately.

Toketa should be announced if, during osaekomi, uke succeeds in “trapping” the leg(s) of tori, either from above or from below the leg.

The referee should pay attention to the following situations where osaekomi is still valid and toketa must not be announced.



In situations where the back of the contestant being held is no longer in contact with the tatami, (e.g. “bridging”), but the contestant applying the hold maintains control, the osaekomi shall continue.

If uke escapes from osaekomi outside the contest area the referee must call toketa.

If there is no immediate continuation from either tori or uke in applying osaekomi waza, shime waza or kansetsu waza, he must call mate.

This kind of osaekomi-waza is not valid and the referee must call mate if there is no progression in the action.



This kind of osaekomi-waza is not valid and the referee must call mate immediately.



It is never allowed to hold an osaekomi just around the head/neck without control of at least one arm.

Article 18 - Prohibited Acts and Penalties

The prohibited acts are divided into:

- Slight infringements will receive a penalty of shido.
- Grave infringements will receive a penalty hansoku-make.

If the referee decides to penalise the contestant(s), (except in the case of sono-mama in ne-waza) he shall temporarily stop the contest by announcing mate, indicate the appropriate gesture for transgression and announce the penalty while pointing to the contestant(s) who committed the prohibited act.

During the contest there will be two shido, and the third will be hansoku-make (2 warnings and then disqualification). Shido do not give a score to the other contestant, only technical scores can give points on the scoreboard.

Shido will be given to the competitor deserving it, in place, without having both competitors return to the formal start position (mate – shido – hajime) except when a shido is given for leaving the contest area.

There are several possibilities for disqualification (hansoku-make). When an athlete receives a hansoku-make they may or may not be allowed to continue in the competition if applicable.

In the case of hansoku-make resulting from progressive penalties, the contestant penalised with three shido is allowed to continue in the competition.

In the case of direct hansoku-make for protection of the judoka (diving head first onto the mat), the judoka is allowed to continue in the competition.

In the case of direct hansoku-make for acts against the spirit of judo the judoka cannot continue in the competition. The referee and judges must inform the person running the competition of this.

A penalty or penalties will not decide the winner, except for hansoku-make (direct or accumulative).

Double hansoku-make (three shido)

In regular time or golden score if both athletes receive three shido, both athletes will be considered losers, the contest result will be recorded as 0-0, with the following consequences:

- Final – both athletes will be awarded 2nd place.
- Bronze medal contest – both athletes will be awarded 5th place.
- Semi-final – both athletes will be awarded 5th place.
- Quarter-final or last 8 repechage – both athletes will be awarded 7th place.
- Rounds prior to the quarter-final – both athletes considered to be losers and will remain in the position they reached on the draw sheet. They can compete in the team event if it follows an individual competition i.e. World Championships, Olympic Games etc.
- Relevant ranking points will be assigned in the case of previous wins.

In a round robin, if both athletes are given three shido, they are considered losers for that contest only and the contest result is recorded as 0-0. They can both compete in the next contest if applicable.

In a team event, if both athletes are given three shido, they are considered losers for that match only and the contest result is recorded as 0-0. They can both compete in the next round if applicable.

Double direct hansoku-make

For a direct hansoku-make given to both contestants (in regular time or golden score), the IJF Ad Hoc Commission will decide the consequences.

Whenever a referee awards a penalty, he should demonstrate with a simple gesture the reason for the penalty.

A penalty can be awarded after the announcement of sore-made for any prohibited act done during the time allotted for the contest or, in some exceptional situations, for serious acts done after the signal to end the contest.

Referees are authorised to award penalties according to the “intention” or situation and in the best interest of the sport.

Should the referee decide to penalise the contestant(s), (except in the case of sono-mama in ne-waza) he shall temporarily stop the contest by announcing mate, should penalise or return the contestants to their starting positions (Article 11) and announce the penalty while pointing to the contestant(s) who committed the prohibited act.

Before awarding hansoku-make, the referee must consult with the judges and make his decision in accordance with the “majority of three” rule. When both contestants infringe the rules at the same time, each should be awarded a penalty according to the seriousness of the infringement.

When both contestants have been given two (2) shido and subsequently each receives a further penalty, they should both be declared hansoku-make. A penalty in ne-waza should be applied in the same manner as in osaekomi.

Shido (Slight Infringements Group):

If a judoka (blue) commits a slight infringement and his opponent (white) throws him (blue) for waza-ari, both the penalty of shido for blue and the waza-ari for white will be given. If it is ippon (white) only the positive score will be assigned.

If a judoka (blue) commits a slight infringement and throws his opponent (white) but the latter (white) takes advantage of the situation to continue in newaza, the referee must announce the penalty for blue and at the same time allow the action to continue in favour of white until it reaches a conclusion either or score or mate. If blue counterattacks (e.g. breaks the osaekomi and takes over the control, breaks the osaekomi by applying shime-waza or kansetsu-waza) the referee must announce mate.

Shido is given to any contestant who has committed a slight infringement:

1. Negative positions, against the fighting spirit, will be penalised by shido (to adopt in a standing position, after kumi-kata, an excessively defensive posture, not searching for an attack, a defensive attitude etc.).
2. To make an action designed to give the impression of an attack but which clearly shows that there was no intent to throw the opponent (false attack). False attacks are defined as:
 - Tori has no intention of throwing.
 - Tori attacks without kumi-kata or immediately releases the kumi-kata.
 - Tori makes a single fake attack or a number of repeated fake attacks with no breaking of uke's balance.
 - Tori puts a leg in between uke's legs to block the possibility of an attack.
3. To pull the opponent down in order to start ne-waza unless in accordance with Article 10. When one contestant pulls his opponent down into ne-waza not in accordance with Article 10 and his opponent does not take advantage of this to continue into ne-waza, the referee shall announce mate and give shido to the contestant who has infringed Article 10 (without returning to the starting position).
4. In a standing position, before or after kumi-kata has been established, not to make any attacking moves. Recognizing the difficulty of preparing a throwing action, the time between kumi-kata and making an attack is 45 seconds as long as there is a positive progression. The referees should penalize strictly the contestant who does not engage in kumi-kata or who tries not to be gripped by the opponent
5. To put a hand, arm, foot or leg directly on the opponent's face. The face means the area within the line bordered by the forehead, the front of the ears and the jaw-line.
6. To go outside the contest area or intentionally force the opponent to go outside the contest area either in standing position or in ne-waza (see Article 5 - Exceptions).

If a contestant puts one foot outside of the contest area without immediate attack or not returning immediately inside the contest area, he is penalised by shido. Two feet outside the contest area is penalised by shido.



If the contestant is pushed outside the contest area by his opponent, then the opponent will receive a shido. (If the competitors leave the contest area, they are not penalised by shido when the attack is engaged in a valid position).

7. To force the opponent with either one or both arms to take a bending position without immediate attack will be penalised by shido for a blocking attitude.



8. To intentionally avoid taking kumi-kata in order to prevent action in the contest. Normal kumi-kata is taking hold the right side of the opponent's judogi, be it the sleeve, collar, chest area, top of the shoulder or back with the left hand and with the right hand the left side of the opponent's judogi be it the sleeve, collar, chest area, top of the shoulder or back and always above the belt or vice versa.

As long as a contestant makes a cross grip, that means with two hands, one hand on the opposite side of the back, shoulder or arm of the other contestant, he should attack immediately, or the referee must penalise with shido. Under no circumstances it is permitted to grab below the belt.

Cross gripping should be followed by an immediate attack. Same rule as for belt gripping and one side gripping.

A contestant must not be penalised for holding with an abnormal grip if the situation has been brought about by his opponent ducking his head beneath the holder's arm. Instead, the judoka who ducking beneath the holder's arm without an immediate attack will be penalised with shido (2).

Hooking one leg between the opponent's legs unless simultaneously attempting a throwing technique is not considered to be the normal kumi-kata and the contestant must attack immediately or the referee must penalise with shido.

9. Unconventional kumi-kata (cross grip, one side grip, belt grip, pocket grip, pistol grip etc.) will be penalised if there is no immediate attack (see the following examples of unconventional kumi-kata).





10. In a standing position, to continually hold the opponent's sleeve end(s) for a defensive purpose or to grasp by "screwing up" the sleeve end(s).

11. In a standing position, to continually keep the opponent's fingers of one or both hands interlocked, in order to prevent action in the contest or to take the wrist or the hands of the opponent only to avoid the grip or the attack on him.

12. To insert a finger or fingers inside the opponent's sleeve or of his trousers either in the ends of the trouser legs or in the waistband.

13. To bend back the opponent's finger(s) in order to break his grip.

14. Breaking the grip of the opponent with two hands (the referee should give shido only in the case of done infringement, not for supposed infringement).



15. Breaking the grip of the opponent with the knee or leg.



16. Cover the upper part of the lapel of the judogi jacket to prevent the grip.



17. Avoid uke's grip with a blow on his arm or hand.



18. Blocking the opponent's hand.



19. Athletes must enter and leave the field of play wearing their judogi in the proper way. If the judogi and/or belt becomes disarranged during the contest the judoka is obliged to quickly rearrange it back to the correct position. This can be between mate and hajime or during any break in action. The referee will award a penalty (shido or hansoku-make if it is the third penalties) towards the contestant (s) who does not re-adjust their judogi correctly between the mate and the subsequent hajime.

To intentionally disarrange his own or his opponent's judogi; to untie or retie the belt or the trousers without the referee's permission; to intentionally lose time arranging his judogi and belt. The referee should never touch a judoka's judogi or belt.



20. Leg grabbing, grabbing the trousers, blocking or pushing the opponent's leg(s) with their hands or arms. It is possible to grip the leg only when the two opponents are in a clear ne-waza position and the tachi-waza action has stopped.



These are valid actions and no shido will be given.



Tori in this tachi-shisei position can apply kansetsu-waza or shime-waza because uke is in a ne-waza position.



21. To encircle the end of the belt or jacket around any part of the opponent's body. The act of "encircling" means that the belt or jacket must completely encircle. Using the belt or jacket as an anchor for a grip (without encircling), e.g. to trap the opponent's arm, should not be penalised.

22. To take the judogi in the mouth (either his own or his opponent's judogi).

23. To put a foot or a leg in the opponent's belt, collar or lapel.

24. To apply shime-waza using either your own or your opponent's belt or bottom of the jacket or using only the fingers.



25. In shime-waza or kansetsu-waza while over-stretching the leg is forbidden: the referee will announce mate immediately and sanction the contestant with shido.



Shime-waza while over-stretching a straight leg is forbidden. Special attention will be given to situations: where tori, whilst applying a shime-waza, also over-stretches and straightens uke's leg. Mate must be called immediately and a shido given.

26. To hug directly the opponent for a throw (bear hug).

Precision: To attack with a bear hug the athlete must have a minimum of one grip.



It is not valid to make a second grip simultaneously. Only touching the judogi or the opponent's hands in order to avoid grips, is not considered as kumi-kata, gripping is necessary.

Bear hug - double points: if, after a blue bear hug, white throws blue for a waza-ari, the score (white waza-ari) and the penalty (blue shido) will be given.

These are valid grips for bear hug.



27. To apply leg scissors to the opponent's trunk (dojime), neck or head (scissor with crossed feet, while stretching out the legs. In shime-waza (e.g. ryote-jime) it is forbidden to use the legs to assist the grip.

28. To kick with the knee or foot, the hand or arm of the opponent, in order to make him release his grip or to kick the opponent's leg or ankle without applying any technique

29. If both of the athletes are in a tachi-shisei (standing position) and one or both apply kansetsu-waza or shime-waza, mate and shido should be announced. However, if the action is dangerous or can injure the opponent, it will be hansoku-make.



30. The act of entangling the leg without making an immediate attack must be penalised with shido.



Hansoku-make (Grave Infringements Group):

Hansoku-make is given to any contestant who commits a grave infringement or who having been given two (2) shido, commits a further slight infringement.

Direct hansoku-make for protection of the judoka: the competitor loses this contest but can continue in the competition if applicable.

1. To “dive” head first, onto the tatami by bending forward and downward while performing or attempting to perform techniques such as uchi-mata, harai-goshi, kata-garuma etc. it is forbidden to somersault forward when uke is on the shoulders or the back of tori.

2. Head defence, to ensure that judo has as little trauma as possible, if uke attempts voluntarily to use the head with any movement which is dangerous for the head, neck or spine, for defence and to avoid landing in / escaping from a score he shall be penalised with hansoku-make.





Special attention will be given to situations where tori attempts to throw his opponent during tachi-waza with, for example, seoi-otoshi (drop seoi-nage), sode-tsurikomi-goshi with the grip on both sleeves and koshi-guruma with both grips on the collar and uke makes an involuntary head defence. These are examples and this situation can occur with other throwing techniques. In this situation there is no penalty for either tori or uke.

Direct hansoku-make for acts against the spirit of judo: judoka are NOT allowed to continue in the competition and will remain in the position they reached on the draw sheet.

1. To apply kawazu-gake (to throw the opponent by winding one leg around the opponent's leg, while facing more or less in the same direction as the opponent and falling backwards into him). Even if the thrower twists/turns during the throwing action, this should still be considered "kawazu-gake" and be penalised. Techniques such as o-soto-gari, o-uchi-gari, and uchi-mata where the foot/leg is entwined with opponent's leg will be permitted and should be scored.



2. To apply kansetsu-waza anywhere other than to the elbow joint. To attempt such throws as harai-goshi, uchi-mata, etc., with only one hand gripping the opponent's lapel from a position resembling ude-hishigi-waki-gatame (in which the wrist of the opponent is trapped beneath the thrower's armpit) and deliberately falling, face down, onto the tatami is likely to cause injury and will be penalised.

No intent to throw an opponent cleanly onto his back is a dangerous action and will be treated in the same way as ude-hishigi-waki-gatame.

3. To fall directly to the tatami while applying or attempting to apply techniques such as ude-hishigi-waki-gatame (see point 2 above).

4. To reap the opponents supporting leg from the inside when the opponent is applying a technique such as harai-goshi etc.

5. To make any action this may endanger or injure the opponent especially the opponent's neck or spinal vertebrae or may be against the spirit of judo.

6. To intentionally fall backwards when the other contestant is clinging to his back and when either contestant has control of the other's movement.
7. To lift off the tatami the opponent who is lying on the tatami and to drive him back into the tatami.
8. To disregard the referee's instructions.
9. To make unnecessary calls, remarks or gestures derogatory to the opponent or referee during the contest.
10. To wear a hard or metallic object (covered or not).
11. Any action against the spirit of judo (this includes anything that can be described as anti-judo) may be punished by a direct hansoku-make at any time in the contest.

When a contestant has repeated slight infringements and is to be penalised with his third (3rd) shido the referee, after consultation with the judges, shall give the contestant hansoku-make, that is to say that the third (3rd) shido is not announced as shido, but shall be announced directly as hansoku-make. The contest ends according to the Article 13.

Article 19 - Default and Withdrawal

The decision of fusen-gachi shall be given to any contestant whose opponent does not appear for his contest according to the 30 seconds rules.

Forfeit of a contest: If one contestant is ready on time and the opponent is missing an IJF Sport Director (or nominated person) will ask the speaker to announce, the last call for the missing athlete.

The referee will then invite the prepared contestant to wait at the edge of the competition area. The scoreboard will start to count down 30 seconds. If at the end of 30 seconds the opponent is still not present the mat referee will invite the athlete to enter the competition area and will be declared the winner by fusen-gachi.

The Referees must be sure before awarding fusen-gachi that they have received the authority to do so by the IJF Sport Director or nominated person.

The IJF Ad Hoc Commission can decide if an athlete forfeiting a contest may participate in the repechage.

The decision of kiken-gachi shall be given to any contestant whose opponent withdraws from the competition for any reason, during the contest.

Any contestant not willing to comply with the requirements of hygiene, hair and head cover regulation (see E1.3 Hygiene) shall be refused the right to compete and the opponent shall win the contest by fusen-gachi, if the contest has not yet started, or by kiken-gachi, if the contest has already started, according to the "majority of three" rule.

If a contestant loses a contact lens during the contest and cannot immediately recover it, and if he then informs the referee that he cannot continue competing

without the contact lens, the referee shall give the victory to his opponent by kiken-gachi after consulting with the judges and IJF Supervisors and/or IJF Refereeing Commission Members.

Article 20 - Injury, Illness or Accident

In this article the person in the role of the doctor is defined in Appendix E.

The decision of the contest where one contestant is unable to continue because of injury, illness or accident during the contest shall be given by the referee after consultation with the judges according to the following clauses:

a) Injury

1. Where the cause of the injury is attributed to the injured contestant he/she shall lose the contest.

2. Where the cause of the injury is attributed to the uninjured contestant the uninjured contestant shall lose the contest.

3. Where it is impossible to determine which of the contestants was the cause of the injury, the contestant unable to continue shall lose the contest.

4. Where there is an injury caused by athletes from another contest that takes place on a nearby tatami. The injured athlete has the right to ask the referee to see the doctor and receive treatment if necessary and is able to continue in the contest if able.

5. Where there is an injury caused by an external object (e.g. LED or advertising board, photographer camera). The injured athlete has the right to ask the referee to see the doctor and receive treatment if necessary and is able to continue in the contest if able.

If during the contest a contestant is injured due to an action by the opponent and the injured contestant cannot continue, the referees should analyse the case and make a decision based on the rules. Each case shall be decided on its own merit.

b) Sickness, generally, where one contestant is taken sick during a contest and is unable to continue, he/she shall lose the contest.

c) Accident, where an accident occurs, which is due to an outside influence (force majeure), after consulting with the IJF Supervisors and/or Refereeing Commission members, the contest shall be considered cancelled or postponed. In those cases of 'force majeure', the Sport Director, the Sport Commission and the IJF Supervisors and/or Refereeing Commission members will take the final decision.

Medical Examinations

a) The referee shall call the doctor, if necessary also inside the contest area, to attend to a contestant who has received a severe impact to the head or back (spinal column), or whenever the referee has reason to believe there may be a grave or serious injury. In either case, the doctor will examine the contestant in the shortest time possible and indicate to the referee whether the contestant can continue or not.

Generally, only one (1) doctor for each contestant is allowed on the competition area. Should a doctor require an assistant(s), the referee must first be informed.

The coach is never allowed on the competition area. The referee shall draw near to the injured contestant to ensure that the assistance provided by the doctor is within the rules.

However, the referee may consult with the judges in case he needs to comment on any decision.

If the doctor, after examining an injured contestant, advises the referees that the contestant cannot continue the contest the referee, after consultation with the judges, shall end the contest and declare the opponent to be the winner by kiken-gachi.

b) The contestant may ask the referee to call for the doctor, but in this case the contest is terminated, and his opponent shall win by kiken-gachi.

c) The doctor may also ask to attend to his contestant, but in this case the contest is terminated, and the opponent will win by kiken-gachi.

In any case whenever the referees are of the opinion that the contest should not continue, the central referee after consulting with the IJF Supervisors and/or Refereeing Commission members, shall end the contest and indicate the result in accordance with the rules.

Bleeding injuries, when a bleeding injury occurs, the referee shall call the doctor to assist in stopping and isolating the bleeding, if possible outside the contest area, with the presence of a judge. The athlete is not allowed to compete while bleeding.

However, the same bleeding injury may be treated by the doctor on two (2) occasions. The third (3rd) time that the same bleeding injury occurs, the referee, after previous consultation with the judges, shall end the contest for the contestant's own safety and he shall declare the opponent to be the winner by kiken-gachi. In any case where the bleeding cannot be contained and isolated, the opponent shall be the winner by kiken-gachi

Minor injuries, a minor injury may be treated by the contestant himself. For example, in the case of a dislocated finger, the referee shall stop the contest (by calling mate or sono-mama) and allow the contestant to reset the dislocated finger. This action should be done immediately with no assistance from the referee or the doctor and the contestant can continue in the contest.

The contestant will be allowed to reset the same finger on two (2) occasions. If the same dislocation occurs a third (3rd) time, the contestant shall not be considered to be in condition to continue in the contest. The referee, after previous consultation with the judges, shall end the contest and declare the opponent to be the winner by kiken-gachi.

The doctors of the organising committee or the accredited doctor of the teams intervene upon request of the referees.

The doctors of the organising committee or teams' doctors must be able to intervene on the field of play, at their own request, when deemed necessary, in case of danger to the athlete(s) health i.e. a bad landing on the head or a strangulation. For justifying this exceptional request, they should stand at the edge

of the competition surface showing two arms in cross in the height of the chest to inform the referee that they wish to make an emergency intervention. The referee must allow the doctor to enter the tatami while stopping the contest.

Three cases are possible:

The team doctor / local organisation doctor / IJF doctor announces that the athlete cannot continue the contest because their health is in danger. The opponent will be declared winner by fusen-gachi.

The team doctor / local organisation doctors / IJF doctor announces that the athlete can continue without danger to his health and the contest continues.

If the intervention of the team's doctor is not justified by the IJF Supervisors and/or IJF Refereeing Commission members and the IJF Medical Commission delegate a final decision will be made about the continuation of the contest and will make an official report (see Appendix E).

Medical Assistance

The medical assistance in the following cases should be outside of the competition area, close to the medical table, the injured contestant must be accompanied by one of the judges.

a) In a minor injury.

In the case of a broken nail, the doctor is allowed to assist in cutting the nail. The doctor may also help in adjusting a scrotum injury (testicles).

b) In a bleeding injury.

For safety measures whenever there is blood it must always be completely isolated with the assistance of the doctor by means of adhesive tape, bandages, nasal tampons, (the use of blood clotters and haemostatics products is permitted). When the doctor is called to assist a contestant, such medical assistance should be given as quickly as possible.

Note: With the exception of the above situations, if the doctor applies any treatment the opponent shall win by kiken-gachi.

Types of vomiting

Any type of vomiting by a contestant shall result in kiken-gachi for the other contestant. (See paragraph: b) Sickness).

In the case when a contestant through a deliberate action causes an injury to the opponent, the penalty given to the contestant inflicting the injury on the opponent shall be a direct hansoku-make, apart from any other disciplinary action that may be taken by IJF Ad Hoc Commission.

When a doctor clearly realises - especially in the case of shime-waza – that there is a serious danger to the health of one of the contestant that he is responsible for, he can go to the edge of the competition area and call upon the referees to immediately stop the contest. The referees shall take all necessary steps to assist the doctor. Such an intervention will necessarily mean the loss of the contest for his contestant and should therefore only be taken in extreme cases.

If a cadet loses consciousness during shime-waza they are no longer able to continue in the competition.

The official team doctor shall have a medical degree and must register prior to the competition. He shall be the only person allowed to sit in the designated area and must be so identified. e.g. by wearing a red cross arm-band or waistcoat.

When accrediting a doctor for their team, the National Federations must take the responsibility for the actions of their doctors. The doctors must be aware of any amendments and the interpretations of the rules.

If an injured athlete needs prolonged medical treatment on the tatami, the referee will declare the non-injured opponent as the winner who will then leave the competition area.

The referee must stay on the tatami observing treatment or emergency procedures until the injured athlete is transported safely from the competition area.

If necessary, the medical team should screen the injured athlete off from the view of the public.

The referee should be the last person to leave the tatami.

If the treatment of the injured athlete is extended onto the safety area of a neighbouring competition area, the Sport Director will stop any contests on affected tatami until it is safe to continue.

Article 21 - Situations not Covered by the Refereeing Rules

When a situation arises, which is not covered by these rules, it shall be dealt with and a decision given by the referees after consultation with the IJF Ad Hoc Commission, Refereeing Commission members and/or IJF Supervisors.





IJF MEDICAL AND ANTI-DOPING HANDBOOK

All medical and on-site anti-doping matters (at competitions) are the responsibility of the IJF Medical Commission. Further information can be found in the Event Organisation Guide. Reference should also be made to Appendix D IJF Refereeing Rules.

E1.1 Medical Requirements

In case of an injury, the priority is the athlete's health. Primarily it is the team doctor (or team physiotherapist) who is responsible for the health of their athletes.

The local organising committee shall provide sufficient medical treatment during the competition, including on site treatment and hospital treatment if needed. They should also provide qualified medical personnel and arrange sufficient medical materials and equipment.

A minimum of one ambulance must be at the competition venue at least 30 minutes before the start of a competition day. In case the ambulance has to leave the venue, a minimum of one ambulance must immediately be available on site for replacement. In the absence of either an ambulance or a team of local organising doctors the competition cannot be started or continued.

E1.1.1 Decision Making on the Field of Play

Only certified (and licensed) medical doctors can enter the field of play and go on the tatami to treat athletes. When a medical decision is needed on the field of play the local organising doctors can assist the team doctor. In case of a dispute between them, the team doctor will take the decision, however the IJF Medical Commissioner has the final say. The same policy applies in the absence of a team doctor.

E1.1.2 Decision Making off the Field of Play

When a medical decision is needed out of the field of play, the decision is up to the team doctor (or team physiotherapist). In the absence of a team doctor when there is a dispute between the team physiotherapist and the local organising doctors, the local organising doctors will take the decision on life threatening situations. However, in any cases if there is a dispute, it is the IJF Medical Commissioner who has the final say.

E1.1.3 Rights and Responsibilities

The IJF Medical Commissioner has the responsibility to:

- Arrange for sufficient hygienic conditions.
- Arrange for sufficient health care for all participants, including staff.
- Assure that there is an acting medical team at the field of play.

The IJF Medical Commissioner has the right to:

- Recommend stopping the competition in case of the delay of the ambulance or the team of local organising doctors is more than 15 minutes.
- Stop a contest in case of a dangerous injury.
- Make a final decision whether an injured athlete can continue the contest or not.

Local organising doctors have the responsibility to:

- Be present at the field of play in sufficient number during the entire competition.
- Have sufficient equipment.

Local organising doctors have the right to:

- Make a decision, in consultation with the IJF Medical Commissioner, whether an injured athlete can continue the contest or not in case there is no team doctor.

E1.2 Medical Suspension Following Concussion

Athletes of all age categories with suspected concussion (confirmed by either the IJF Medical Commission delegate if a Medical Doctor, or by the relevant event's head of medical services) are not allowed to compete within the period of seven (7) days starting the day after the date of the injury. Athletes can return to competition having a medical clearing from their team medical doctor, family doctor or any other medical doctor having the authority to issue such a clearing. The IJF Medical Commission will register athletes under medical suspension.

Recognition of a concussion:

The concussion is a traumatism of the head or the neck that alters the brain function in an immediate or transitional way. In nine (9) cases, out of 10, it is not associated with loss of consciousness. It is very important, in case of traumatism, to respect safety instructions in order to preserve the athlete's health and to ensure an appropriate medical follow-up.

Signs of recognition

During the contest:

- Loss of consciousness, convulsions.
- Disorder of balance, of vision (seeing stars, double vision).
- Headache, tiredness, confusion, somnolence.
- Memory troubles (to ask simple questions: their name, the place...).

After the contest:

- Irritability, sadness, impression of drunkenness.
- Hypersensitivity to noise, to light.
- Sleep disorders.
- Reduction of performance.

Safety instructions:

- To stop the contest immediately.
- The athlete must be taken care of by a doctor or a person who has a close relationship with the athlete.
- To respect the rest period prescribed by the doctor.
- To officially inform in writing the IJF Medical Commission.
- Return to activity only with a medical certificate specifying the date.

E1.3 Hygiene

- The Judogi shall be clean, generally dry and without unpleasant odour.
- The nails of the feet and hands shall be cut short.
- The personal hygiene of the contestant shall be of a high standard.
- Long hair shall be tied up so as to avoid causing any inconvenience to the other contestant. Hair shall be tied by means of a hair band made of rubber or similar material and be void of any rigid or metal components. The head may not be covered except for bandaging of a medical nature, which must adhere to this one.
- Any contestant not willing to comply with the requirements of hygiene, judogi rules or the head cover regulation shall be refused the right to compete and the opponent shall win the contest by Fusen-gachi, if the contest has not yet started, or by kiken-gachi, if the contest has already started, according to the "majority of three" rule.

E1.4 Doctors' Code of Conduct

Doctors must respect the Code of Ethics, statutes and regulations of the IJF. In the case of an infringement proven, penalties may range from a simple verbal warning to exclusion of competition.

They shall:

- Sit in the delegation doctor's chair while their athlete is competing.
- Enter the tatami when called by the referee.
- Not coach, shout, cheer or film.

Doctors must respect the following dress code:

- Doctors shall always wear their accreditation on the field of play as well as in the warm up area. The doctor's symbol should appear on their accreditation.
- Jeans, overalls, shorts, 3/4 length trowsers, leggings, sandals, any kind of head caps or cover, flip flops, body or facial piercings are not allowed, low-cut necklines and mini-skirts are not allowed.
- Avoid jewellery that could scratch or touch a patient while getting close to examine him/her.
- Garments that may interfere with clinical communication, and its assessment, shall be removed.
- Change immediately if uniforms or clothes become visibly soiled with blood stains or other.
- Tie long hair off the collar.
- Avoid manicure and jewellery that could scratch or touch a patient while getting close to examine the athlete.
- Wear soft-soled, closed toe shoes.
- Cover tattoos where these are extensive or may be deemed offensive.
- Shall not wear neck-ties.

E1.5 Doping Control Requirements

The local organising committee must provide and arrange for doping control following the World Anti-Doping Agency (WADA) rules (International Standard for Testing and Investigation - ISTI) for both urine and blood testing respecting the minimum level of analysis as given in the Technical Document for Sport Specific Analysis (TDSSA).

The Doping Control Station (DCS) has only one function providing space for doping tests. No other function or unauthorised traffic (no weight control, no use as medical / emergency room, no use as dressing room) is allowed. It must be guarded, locked and clearly separated from the competition area. The location of the DCS shall be marked with clear signs from various directions. No filming or picture taking is allowed in the doping control area.

E1.5.1 Event Testing

During IJF events athletes can be requested to provide samples for either an in- or out-of-competition test.

Doping control for in-competition tests is carried out under the supervision either of an IJF Medical Commissioner or a representative of the IJF Medical Commission. Out-of-competition tests are the responsibility of the authorised Sample Collection Authority.

For veteran and kata competitions there will be no doping control.

E1.5.2 Selection Procedure for Doping Control

The selection criteria for doping control is defined for each event in the event's outlines. The IJF Medical Commission delegate together with an IJF Official and a representative of the responsible Sample Collection Authority will carry out the draw; all participants must sign the draw protocol.

Any further tests are at the discretion of IJF or an authorised Testing Authority.

E1.5.3 Athlete Notification

Athletes are notified according to ISTI 5.4. For in-competition tests athletes are notified after their last contest on a day.

E1.5.3.1 Modification for Minor Athletes

Athletes who are minors should be notified and tested in the presence of an adult accompanying person of their choice respecting the WADA rules (ISTI, Annex C).

E1.5.4 Accredited Laboratory

Only WADA accredited/approved Laboratories can analyse the samples. The Doping Control Coordinator has to inform the IJF Medical Commissioner about which laboratory will be used.

In case of Adverse Analytical Finding detected, the IJF will follow the IJF Anti-Doping Rules.

The IJF Medical Commission delegate has the right to cancel or stop a test if it is medically justified.





IJF DISCIPLINARY CODE AND CODE OF ETHICS

IJF Statutes Annexe 1: IJF DISCIPLINARY CODE

The present Code established in conformity with the provisions of Articles 30, 31 and 32 of the IJF Statutes, was adopted on 21 August 2013 by the IJF Executive Committee and the IJF Congress on 23 August 2013. The IJF disciplinary bodies have the authority to investigate any fact or incident contrary to the judo moral code, to the principle of mutuality, to the IJF Statutes and regulations or that is likely to be the subject of penal action in the country of origin of the accused person and attributable to IJF individuals or legal entities, of its members and members affiliated to them.

Anything contrary to the moral, ethical, deontological or sporting spirit of judo, affecting its image and reputation and the failure to comply with the rules defined by the Association of Summer Olympic International Federations (ASOIF) and the International Organising Committee (IOC) in terms of sports betting are subject to sanction by the IJF disciplinary bodies.

The present code does not apply to the exercise of the disciplinary authority in terms of anti-doping.

Section I

Provisions Regarding the Disciplinary Body of IJF

Article 1 Preamble

In accordance with the IJF Statutes, a disciplinary body is established by the IJF, the IJF Disciplinary Commission, ruling in first instance, which has the authority to discipline members of the IJF and its affiliates. It covers any fact or incident that occurs during IJF judo activities or related events. In the case of incontestable gross misconduct, the IJF President, in consultation with the General Secretary, may take provisional precautionary measures before the deliberation of any disciplinary body. The same Disciplinary body will form the Disciplinary Appeal Commission for the cases judged in First Instance by Continental Unions or Member National Federations.

The appeal is suspensive unless otherwise decided by the disciplinary body of First Instance, duly motivated. The Appeal Commission will come to a decision on the basis of the submitted argument.

ALL APPEAL REQUESTS TO CONTINENTAL UNIONS THAT ONLY HAVE DISCIPLINARY BODIES OF FIRST INSTANCE WILL BE DEALT WITH BY THE IJF OR COURT OF ARBITRATION FOR SPORTS.

The decision of the IJF Disciplinary Commission is subject to appeal by the person concerned or the IJF Executive Committee with the Court of Arbitration for Sport (CAS).

Bylaw 1a) In the case that the appeal does not emanate from the accused person, the disciplinary appeal body informs him /her immediately and indicates the deadline for submitting his/her observations. The IJF Executive Committee, if it does not agree with the decision, has the right to appeal.

Article 2 Composition

The IJF Disciplinary Commission is comprised of five members. The IJF President proposes five names from the list of judges (art 30.2 of the IJF Statutes) to the IJF EC for approval. The names of the President and the Vice-President for each session, proposed by the IJF President must also be approved by the EC. The Commission can validly debate while at least 3 members are present. The members of the Disciplinary Commission cannot be members of the IJF Executive Committee. The members cannot be indemnified or paid by the IJF, but their expenses will be reimbursed in accordance with financial regulation.

Byelaw 2a) In the case of the absence or definitive exclusion of the President of the IJF Disciplinary Commission of First Instance, the presidency is assumed by the Vice-President or, in his absence, by its oldest member. In the case of the definitive exclusion of a member of the list, a new member is appointed under the same conditions as his (her) predecessor for the remaining period of the mandate.

Article 3 Admissibility of complaints and initiation of the procedure

The IJF members can ask the IJF Executive Committee to make use of the IJF Disciplinary bodies for any fact or incident that occurs during the judo activities of the National Federations or the Continental Unions. Only the IJF Executive committee, represented by the IJF President, can decide on the initiation of the disciplinary procedure.

At the initiation of the procedure, the IJF General Secretary informs the person concerned and, if appropriate, the persons with parental/guardian responsibility and the legal representative that a disciplinary procedure is initiated against him/her by sending a written document informing them about the allegation, by a registered letter or any other means that allows proof of receipt by the addressee. The instruction period then starts.

If the General Secretary has any connection to the case, the appointment of the Commission members and the notices are made by any member of the Executive committee appointed by the IJF President.

Byelaw 3a) The IJF Executive Committee can give authority to the disciplinary instance of a Union or a National Federation member of the IJF in order to assume the disciplinary power usually coming within the competence of the IJF disciplinary bodies.

Byelaw 3b) A case can be referred to the IJF Disciplinary Commission of First Instance by the IJF Executive Committee on the request of a private individual or legal entity affiliated to the IJF.

Byelaw 2c) In the case of conflict of interest, the IJF Executive Committee decides which authority is most competent to hear the case.

Byelaw 3d) Any member of the IJF Executive Committee with any connection to the case will not take part in the decision.

Article 4 Conciliation between the parties

A member of the Executive Committee can be appointed before the initiation of the disciplinary procedure to proceed to conciliation. After the proposed agreement of the parties, the member of the EC will propose the conciliation to the IJF EC.



In the case of the refusal of the parties or the EC to accept the decision, the disciplinary procedure will be initiated.

Article 5 Investigation and referral to the Disciplinary Commission

The seisin is made either after the report required by the Executive Committee or the IJF President, or also directly by the IJF President.

Article 6 Notice

The accused individual accompanied, if appropriate, by persons with parental/guardian responsibility, is called before the Disciplinary body by the IJF General Secretary. This notice is sent at the request of the President of the concerned disciplinary body, by registered letter or by any other means that allows proof of receipt by the addressee, at least fifteen (15) days before the date of the session. The notices can be sent by email, if the instruction can be certain of a reliable email address.

When the disciplinary procedure is initiated against a legal entity, its legal representative is called under the same conditions. The person concerned can choose to defend itself by setting up a file.

Byelaw 6a) The person concerned can only be represented by a lawyer. He/she can be assisted by a person of his /her choice. If he/she does not understand English, French or Spanish well enough, he/she can be assisted by a translator.

Byelaw 6b) The person concerned, or his/her defender can consult the report and the contents of the file before the session. He/she can request witnesses of his/her choice; their names should be communicated at least eight (8) days before the meeting of the disciplinary body. The President of the Jury can refuse to hear any testimony that he deems abusive. These consultations can be made by electronic means.

Byelaw 6c) The notice mentioned in paragraph 1 indicates to the person concerned his/her rights, as defined in the present article. Travel expenses of the appellant will not be reimbursed. The deadline of fifteen (15) days mentioned in the first paragraph can be reduced to eight (8) days in case of emergency or upon request. In this case, the right to require the hearing of the persons is applied without any deadline. The deadline can exceptionally be shorter than eight (8) days if the person against whom the disciplinary procedure is started is participating in a competition. The place of the hearing will be determined by the President of the Jury, with the agreement of the IJF President taking into account the place of residence of the judges, and the parties and the suitability and availability of the venue.

Article 7 Adjournment

In the emergency case mentioned in the last paragraph of the previous article and except in the case of a force majeure, the adjournment of the case cannot be requested. The request for an adjournment in first instance or in appeal must be received at least eight days before the hearing and may only be requested once.

Article 8 Hearing

The President of the Jury can hear any person whose evidence is deemed useful. If such a hearing is decided upon, the President of the Jury informs the person concerned. The person concerned and, where necessary, the defender is invited to speak at the end of the hearing.



Article 9 Confidentiality

All facts, incidents and information that the President of the Jury, the members of the disciplinary bodies and the secretaries of session gain knowledge of, whilst carrying out their duties, are confidential. Any breach of confidentiality will result in the termination of the functions of the disciplinary body member or the secretary of the session.

Article 10 Decision

The Disciplinary Commission makes a judgment based on the evidence.

Byelaw 10a) The decision will include the following points:

Debate, analysis, sanction, application details, information, means and deadline of appeal and the date of sanction commencement.

Byelaw 10 b) The decision is signed by the President of the Jury and the secretary of the session who is responsible for the drafting of the report of the session.

The Secretary of the session can be one of the members of the Disciplinary Commission.

The IJF President and the General Secretary are immediately notified by letter addressed under the same conditions as those defined in article 6. They then inform the persons concerned and the IJF Executive Committee.

Article 11 Deadline

The IJF Disciplinary Commission of First Instance must pronounce its judgment within sixteen (16) weeks of the initiation of disciplinary proceedings. When the Commission is established in Disciplinary body of appeal the sixteen (16) weeks deadline is in effect as from its seisin.

Where no decision is taken within this period, the case is removed from the disciplinary body of First Instance to the EC which should reorganise the procedure within two (2) weeks. Otherwise, the disciplinary procedure will be cancelled.

Byelaw 11a) In the case that the session was adjourned in accordance with article 7, the deadline mentioned in the previous paragraph is extended for a period equal to the adjournment period.

Section II

Disciplinary Sanctions

Article 12 Sanctions

The disciplinary sanctions should be chosen from the measures below:

1. Sports penalties such as downgrade, disqualification, withdrawal of a medal or title.
2. Disciplinary sanctions chosen from the following measures:
 - a) Warning
 - b) Reprimand
 - c) Suspension from a competition or duties
 - d) Fines, though they cannot exceed the fines set for the contraventions under Swiss law.
 - e) Provisional or definitive withdrawal of the status of the IJF member and all its affiliated components.
 - f) Expulsion
3. Ineligibility to the governing bodies for a specified period.
In the case of the first sanction, suspension from a competition can be replaced, with the agreement of the person concerned and, if any, of his/her legal representative, by the performance of activities of general interest for a set period, for the benefit of a federation or a sports association.

Article 13 Commencement of sanctions

The disciplinary body sets the date when the sanctions become effective. If this is not possible, the sanctions will be effective from the date of the notification of the decision to the person concerned.

Article 14 Suspended sentence

The sanctions mentioned in point 2c and 2e of article 12 of the present byelaw may, in the case of the first sanction, be totally or partly suspended.

A suspended sanction is deemed void if, within 3 years of the sanction being pronounced, the person concerned was not the subject of any sanction mentioned in 2c and 2e of article 12. Any new sanction within this period results in the revocation of the suspension.

IJF Code of Ethics

1. INTRODUCTION

Judo, an Olympic sport since 1964, was created in 1882 by Jigoro Kano as a martial arts discipline with its principle objectives being the physical and intellectual education of Men and Women.

In compliance with the major principles which have led to the creation of Judo, the International Judo Federation has established a Code of Ethics adapted to everyone involved in judo. This Code of Ethics reflects the major principles of the Code of Ethics of the IOC, which serves as a reference and must be respected.

Therefore, the IJF, its ethics, and everyone involved in organising an IJF event are required to apply these educational values and this code of behaviour and to ensure that the Code of Ethics is adhered to in all fields, places and circumstances (competition venue, training venue, media platforms, etc.).

2. IOC CODE OF ETHICS

DIGNITY

Safeguarding the dignity of the individual is a fundamental requirement of the Olympism. There shall be no discrimination between the participants on the basis of race, gender, ethnic origin, religion, philosophical or political opinion, marital status or other grounds.

All doping practices at all levels are strictly prohibited. The provisions against doping in the World Anti-Doping Code shall be scrupulously observed.

All forms of harassment of participants be it physical, professional, religious, political, hierarchical or sexual, and any physical or mental injury to participants are prohibited. All forms of participation in, or support for, all forms of promotion of betting related to sport in general and more specifically to the Olympic Games are prohibited and must not, by any manner whatsoever, infringe upon the principle of fair play, show non-sporting conduct, or attempt to influence the result of a competition in a manner contrary to sporting ethics...»

All the IJF Managers and Officials, its continental, national and other member bodies undertake to respect the provisions of the Olympic charter and the Code of Ethics of the IOC and the IJF. (Wherever the term «Olympic Parties» is used, it refers to the IJF and its structures and the Olympic bodies).

3. COMPETITORS

The competitors, and especially the Champions, are the face of judo; they must convey, through their behaviour, the educational values and the ethics of our discipline.

The champions on and off the mat represent the image of judo.

RESPECT FOR THE CONTEST CEREMONY

The ceremony of the bow was formalised by the IJF Education Commission. It must be scrupulously observed.

The bows and particularly the bow to the opponent at the beginning of the contest must be respected rigorously and it is prohibited to use bows or ceremonies from other combat sports or disciplines.

It is, of course permissible to congratulate the opponent at the end of the contest or apologize for an awkward gesture.

RESPECT FOR THE RULES

- The rules of the sport, and its anti-doping and betting regulations must be scrupulously respected.

RESPECT FOR PEOPLE AND THE FACILITIES

- At all times opponents, coaches, referees, organisers, guests, the media, and the public must be spoken to calmly and with respect, without making aggressive or obscene gestures.
- The anti-doping code and sport betting regulations must be adhered to.
- Both victory and defeat must be accepted by exercising self-control and without showing any ostentatious behaviour.
- Exercise self-control and remain disciplined in all circumstances.
- Do not abuse any equipment and ensure all facilities, hotels and other places put



- at your disposition are respected.
- Judokas represent the sport of Judo and the national teams of their countries.

RESPECT FOR THE INSTRUCTIONS AND THE PROTOCOL

- Respect the competition regulations and the instructions of the organisers and in particular the schedules and different protocols.
- Be respectful and always control one's attitudes and feelings during awards ceremonies and any other functions.

RESPECT FOR HYGIENE

- Physical appearance and cleanliness are important. Guard against any contagion. Appear with a clean judogi in accordance with the IJF regulations. Wear shoes at all times off the mat and never go on either the competition mat or the warm-up mat with shoes on.

RESPECT FOR OTHERS

- Do not show any object, sign or religious gesture or movement of any ostentatious form before, during or after the contest or during the formal ceremonies.

RESPECT FOR DECISIONS

- Respect the referees' decision, without complaint, both during and after the competition.
- NEVER VOLUNTARILY LOSE A CONTEST and always inform the IJF of any gift offered to fix a contest.

4. COACHES AND THEIR TEAMS

EXERCISE FAIR PLAY

- Respect the opponent, his/her coach, the members of his/her team, the referees, any persons involved in the organisation, the guests, the media, and the public.
- Comply with the rules of fair play and always exercise exemplary manners.

RESPECT FOR THE RULES

- Respect the Code of Ethics, the IJF statutes and regulations, and the sport organisation regulations, anti-doping and betting rules, follow the instructions of the organisers and in particular the schedules and protocols.
- Observe the role of the coaches without exceeding it.
- Only gifts of very small value may be offered or accepted, as a token of appreciation or friendship by the Olympic parties or the IJF, in compliance with local custom. Any other gift must be handed by the beneficiary to the organisation to which he/ she belongs.
- Hospitality towards the members and staff of the Olympic parties and anyone accompanying them must not exceed the norms of the host country.
- Respect the regulations regarding any conflicts of interest.
- Follow scrupulously the rules and instructions of the IOC on sports betting.
- Respect the impartiality and defend the integrity of the refereeing body.

RESPECT FOR ETIQUETTE

- Follow and respect the dress code required for each of the different phases of the competition and the events relating to it.
- Remain modest in victory and accept defeat with dignity. Exercise self-control and discipline: do not show anger or frustration – control one's feelings.
- Respect the decision of the referees, without complaint both during and after the contest.

- Always behave in a dignified and respectful manner.

RESPECT FOR OTHERS

- Do not show any object, sign, religious gesture or movement of any ostentatious nature before, during or after the contest or during any official ceremonies.
- Do not show disrespect to others by making any uncontrolled gestures or through any other actions not in compliance with the current rules in the spirit of Judo before, during or after a contest.
- Do not be physically or verbally abusive either in competition and/or in training, towards any judoka or any other person.

RESPECT FOR THE FACILITIES

- Look after all equipment and respect the facilities in all allocated areas and spaces, including hotels and other accommodations.
- Judokas are expected wherever they are to represent their sport and discipline and the national teams of their countries.

5. REFEREES

RESPECT FOR THE RULES AND REGULATIONS

- Respect the IJF's Code of Ethics, statutes and regulations, as well as the competition organisers' regulations. Always respect the instructions of the organisers and in particular the schedules.
- Follow the duties and tasks within the referees' areas of responsibilities without exceeding them. Respect the referees' code of ethics.
- Only gifts of very small value may be offered or accepted, as a token of appreciation or friendship by the Olympic parties or the IJF, in compliance with local custom. Any other gift must be handed in by the beneficiary to the organisation to which he/she belongs.
- Hospitality towards members and staff of the Olympic parties and anyone accompanying them must not exceed the norms of the host country.
- Respect the regulations regarding conflicts of interest.
- Respect scrupulously the rules and instructions of the IOC on sports betting. Respect the impartiality and defend the integrity of the refereeing body.
- Referees who have been selected for World Championships or the Olympic Games may only officiate in countries other than their own with the agreement of the President of the IJF. Failure to do so will result in deselection.

RESPECT FOR ETIQUETTE

- Wear the correct uniform and follow the dress code.
- Exercise self-control, courtesy and good manners both on and off the mat, in all circumstances, whatever the environment by controlling one's attitudes and emotions.
- Reserve your judgment about the refereeing decisions taken during the competition.
- Avoid making any statements during the competition, except if requested or authorised by the IJF.

6. MANAGERS

RESPECT FOR THE RULES

- The managers of the IJF, the Continental Unions and the member federations are the legal representatives of world judo and in this capacity, should behave accordingly.
- Respect the Code of Ethics, the IJF statutes and regulations, the role of the



manager without exceeding it.

- Only gifts of very small value may be offered or accepted, as a token of appreciation or friendship by the Olympic parties or the IJF, in compliance with local custom. Any other gift will be handed by the beneficiary to the organisation to which he/she belongs.
- Hospitality towards the members and staff of the Olympic parties as well as the persons who accompany them must not exceed the norms of the host country.
- The parties will respect the regulations regarding conflicts of interest.
- Respect scrupulously the rules and instructions of the IOC on sports betting.

RESPECT FOR ETIQUETTE

- Follow the dress code appropriate to the events.

RESPECT FOR OTHERS

- Do not show any object, sign, religious gesture or movement or any ostentatious form before, during or after the contest or during the official ceremonies.
- Do not be disrespectful by making any uncontrolled gesture or through any other action not in compliance with the current rules in the spirit of judo before, during or after the contest.
- Do not be violent, either physically or verbally towards competitors or any other person.

RESPECT FOR RESOURCES

- Manage in full transparency the resources put at the disposal of the managers by the sports and private bodies and account for their use.

7. BREACHES TO THE CODE OF ETHICS

- If there is proof of a breach to the Code of Ethics, depending on the seriousness of the established facts, a verbal warning is given or, if necessary, a written report is forwarded to the IJF General Secretary in the week following the incident.
- The written report must be explicit and record accurately the facts of the incident naming the involved persons, quote the testimonies and specify the addresses and telephone numbers of the witnesses who can contribute to a better understanding of the incident. The report must be written in one of the three official languages of the IJF. An acknowledgement of receipt will be sent to the concerned party.
- Depending on the established facts, a decision will be proposed to the IJF Executive Committee by the IJF Ethics Commission about any further actions to be taken.
- If the IJF Executive Committee considers that the facts require convening a session of the Disciplinary body of First Instance, it will act accordingly.



SPORT COMPETITION

All sport competition matters are the responsibility of the IJF Sport Commission.

G1.1 IJF Event Phases

The competition normally consists of two sessions, preliminaries and the final block.

The competition phases that take place in the sessions depends on the type of event. Any changes to this will be agreed and approved by the IJF Head Sport Director.

Depending on the number of participants some rounds may not be required for every category.

Event	Competition type	Event phase
Grand Prix	Quarter-final repechage	Preliminaries <ul style="list-style-type: none"> - Elimination round of 128 - Elimination round of 64 - Elimination round of 32 - Elimination round of 16 - Quarter-finals - Repechage - Semi-finals
		Final block <ul style="list-style-type: none"> - Contests for bronze medal - Final – gold medal
Grand Slam	Quarter-final repechage	Preliminaries <ul style="list-style-type: none"> - Elimination round of 128 - Elimination round of 64 - Elimination round of 32 - Elimination round of 16 - Quarter-finals - Repechage - Semi-finals
		Final block <ul style="list-style-type: none"> - Contests for bronze medal - Final – gold medal
Masters	Quarter-final repechage	Preliminaries <ul style="list-style-type: none"> - Elimination round of 32 - Elimination round of 16 - Quarter-finals - Repechage - Semi-finals
		Final block <ul style="list-style-type: none"> - Contests for bronze medal - Final – gold medal

World Championships Seniors	Quarter-final repechage	Preliminaries <ul style="list-style-type: none"> - Elimination round of 128 - Elimination round of 64 - Elimination round of 32 - Elimination round of 16 - Quarter-finals
		Final block <ul style="list-style-type: none"> - Repechage - Semi-finals - Contests for bronze medal - Final – gold medal
World Championships Juniors and Cadets	Quarter-final repechage	Preliminaries <ul style="list-style-type: none"> - Elimination round of 64 - Elimination round of 32 - Elimination round of 16 - Quarter-finals - Repechage - Semi-finals
		Final block <ul style="list-style-type: none"> - Contests for bronze medal - Final – gold medal
World Championships Mixed Teams	Quarter-final repechage	Preliminaries <ul style="list-style-type: none"> - Elimination round of 64 - Elimination round of 32 - Elimination round of 16 - Quarter-finals - Repechage - Semi-finals
		Final block <ul style="list-style-type: none"> - Contests for bronze medal - Final – gold medal
World Championships Open	Quarter-final repechage	Preliminaries <ul style="list-style-type: none"> - Elimination round of 64 - Elimination round of 32 - Elimination round of 16 - Quarter-finals
		Final block <ul style="list-style-type: none"> - Repechage - Semi-finals - Contests for bronze medal - Final – gold medal

G1.2 Athlete Scoreboards

The scoreboards must be placed in such a way that they are visible to the athletes, coaches, referee, judges, the IJF Supervisors and the IJF Refereeing Commission members. They can be stand-alone TV screens or integrated in the LED.

The scoreboards must show:

- The name of the athletes.
- Which athlete is wearing the white judogi and which is wearing the blue judogi.
- The three-letter country code.
- The country flag.
- Weight category.
- The time.
- Scores and penalties.
- Event phase (including golden score).



G1.3 Standard Forms for IJF Events

Delegation Confirmation List



Delegation Control List

Grand Prix Hohhot 2018



JPN

Japan

#	Category	Change	FAMILY NAME	Given Name	Gender	DoB	WRL	ID	Coach Finals		
1	-60 kg		OSHIMA	Yuma	m	07.01.1995	45	7F3A-BA85	1		
2	-66 kg		MARUYAMA	Joshiro	m	11.08.1993	24	C1C1-D6F4	2		
3	-73 kg		HASHIMOTO	Soichi	m	24.08.1991	1	382E-6632	3		
4	-81 kg		SASAKI	Takeshi	m	16.07.1996	51	7742-2B57	4		
5	-90 kg		BAKER	Mashu	m	25.09.1994	25	97B6-64BC	5		
6	-100 kg		NISHIYAMA	Daiki	m	20.11.1990	268	EBC3-ACFD	6		
1	-48 kg		KONDO	Ami	w	09.05.1995	6	BA3A-77AD	7		
2	-52 kg		ABE	Uta	w	14.07.2000	8	6D7A-58DC	8		
3	-57 kg		TAMAOKI	Momo	w	16.09.1994	17	B73D-F36C	9		
4	-63 kg		NOUCHI	Aimi	w	14.01.1996	17	3AAD-F626	10		
5	-70 kg		ARAI	Chizuru	w	01.11.1993	1	67B2-E53F	11		
6	-78 kg		SATO	Ruika	w	27.03.1992	8	BB3E-5BFC	12		
7	+78 kg		SONE	Akira	w	09.07.2000	13	7643-5D56	13		
1	Coach		INOUE	Kosei	m	15.05.1978		A4C6-AF82	A	14	
2	Coach		KONEGAWA	Minoru	m	11.11.1978		935F-73D2	B	15	
3	Coach		MASUCHI	Katsuyuki	m	29.09.1970		C675-7BBF	C	16	
4	Coach		MORIYASU	Yoshimitsu	m	14.09.1972		E3AA-773D	D	17	
5	Coach		YAMAMOTO	Kazuyuki	m	17.07.1975		5E97-ED3E	E	18	
6	Coach		UENO	Yoshie	w	01.07.1983		EC4E-BA87	F	19	
7	Team-Official		ITAMI	Naoki	m	26.01.1993		2C83-DB5B		20	
8	Team-Official		ITO	Yasushi	m	06.12.1994		A7AD-2D57		21	
9	Team-Official		ONO	Yuki	m	22.03.1984		CB46-FEB1		22	
10	Referee		OKADA	Yasuhiko	m	24.07.1968		741F-EFDA		23	
11	Physiotherapist		HIROSE	Kazumasa	m	14.01.1992		865A-E2FA		24	
12	Physiotherapist		ISOBE	Masahiko	m	02.11.1984		2B36-73FA		25	

Please confirm that above categories, name spellings and seeding information are correct and complete
 Veuillez vérifier et confirmer que les noms et les poids sont corrects et complets
 Favor confirmar que la información de los competidores así como los datos de siembra son correctos y completos

X

Signature team leader

Delegation checked	Finances checked		

Weigh-in List

Weigh-in List
Grand Prix Hohhot 2018
-60 kg

#	Nation	FAMILY NAME	Given Name	Date of birth	Exact weight <small>(one position after decimal point)</small>	Signature of player <small>(only in case of overweight)</small>	Out
1	BRA	PELIM	Phelipe	05.01.1990			
2	BRA	TAKABATAKE	Eric	09.01.1991			
3	CHN	LIU	Wenzhi	28.07.2000			
4	CHN	SHANG	Yi	16.03.1994			
5	CHN	SU	Rilege	14.04.1995			
6	CHN	ZHANG	Haiyang	14.02.1999			
7	GBR	MACDONALD	Neil	06.05.1997			
8	JPN	OSHIMA	Yuma	07.01.1995			
9	KAZ	KYRGYZBAYEV	Gusman	28.09.1992			
10	KAZ	SMETOV	Yeldos	09.09.1992			
11	KOR	LEE	Harim	27.06.1997			
12	LAO	SITHISANE	Soukphaxay	01.05.1996			
13	MAR	BASSOU	Issam	12.10.1998			
14	MGL	DASHDAVAA	Amartuvshin	15.12.1987			
15	MGL	GANBAT	Boldbaatar	03.01.1987			
16	NED	KOFFJBERG	Roy	14.01.1996			
17	NED	TSJAKADOEAE	Tornike	05.10.1996			
18	NEP	BAM	Mohan	12.06.1991			
19	PRK	JON	Pae Dong	21.10.1994			
20	PRK	PAK	Yong Nam	27.04.1996			
21	RUS	MSHVIDOBADZE	Robert	17.08.1989			
22	RUS	OGUZOV	Albert	28.09.1991			
23	TPE	YANG	Yung Wei	28.09.1997			

NAME and Signature Weigh-in Official	NAME and Signature Weigh-in Official	NAME and Signature Weigh-in Official	NAME and Signatur Sports Director



Example of Contest Order



IJF Grand Slam Paris 2010

(FRA Paris, 6-7 February 2010)

Contest Order Tatami 1

Category: -60 kg

Preliminary round, Contest # 1							
1)	-60 kg	UZB	<i>SOBIROV, Rishod [1001]</i>	[1] ALVES, Breno	BRA		
Preliminary round, Contest # 3							
2)	-60 kg	BEL	BOMBOIR, Damien [1008]	[5] MEREBASHVILI, Paata	GEO		
Preliminary round, Contest # 4							
3)	-60 kg	FRA	<i>MILOUS, Sofiane [1009]</i>	[13] KOPIJSKE, Robert	GER		

Category: -48 kg

Preliminary round, Contest # 1							
4)	-48 kg	JPN	<i>FUKUMI, Tomoko [1001]</i>	[1] BENARD, Elena	FRA		
Preliminary round, Contest # 4							
5)	-48 kg	NED	<i>ENTE, Birgit [1009]</i>	[13] GARATEJO, Stefany	COL		
Preliminary round, Contest # 5							
6)	-48 kg	HUN	<i>CSEKOVICZKI, Eva [1004]</i>	[3] MESTRE, Dayaris	CUB		

Category: -60 kg

Preliminary round, Contest # 7							
7)	-60 kg	MAR	<i>IDRISSI, Alae [1005]</i>	[7] MESSINA, Martin	CMR		
Preliminary round, Contest # 8							
8)	-60 kg	HUN	<i>BURJAN, Laszlo [1012]</i>	[15] MUSLIMOV, Artur	RUS		

Example of Referees' List



Referee List Grand Slam Tokyo 2017

REF

01.12.2017

#	Nation	FAMILY NAME	Given Name	Number	Tatami	Selected	Referee	Judge	Classification
1	HUN	FRIDRICH	Annamaria	1	I				
2	JPN	OKADA	Yasuhiko	2	I				
3	BRA	VIEIRA	Jeferson	3	I				
4	EGY	ANWAR ALI	Khaled	4	I				
5	ITA	CHYURLIA	Roberta	5	I				
6	JPN	AMANO	Akiko	6	II				
7	AUT	POIGER	Roland	7	II				
8	MEX	GARCIA	Everardo	8	II				
9	AUS	PETR	Lubomir	9	II				
10	RUS	SMOLIN	Vasily	10	II				
11	MGL	TURBAT	Enkhtsetseg	11	III				
12	FIN	KARINKANTA	Velimatti	12	III				
13	DOM	CRUZ	Orlando	13	III				
14	UZB	PERETEYKO	Vyacheslav	14	III				
15	GEO	NUTSUBIDZE	Vladimer	15	III				
16	KOR	HYUN	Sook Hee	16	IV				
17	GER	WOLF	Frank	17	IV				
18	GUA	CABEIRO	Andres	18	IV				
19	TJK	SHAMIROV	Ramzi	19	IV				
20	TUR	BAYAT	Nedim	20	IV				
21	FRA	BATAILLE	Matthieu	21	IV				



Example of Contest Sheet

Weight Category Catégorie de Poids	Gender Genre	Date	Mat	Obs	N°

White / Blanc	Ctry/Pays	Blue / Bleu	Ctry/Pays

IPP	WAZ	SHIDO	IPP	WAZ	SHIDO
X/H / 3	2	1	X/H / 3	2	1

GS	IPP	WAZ	SHIDO	IPP	WAZ	SHIDO	GS
	X/H / 3	2	1	X/H / 3	2	1	

SCORES	TECHNIQUES / PENALTIES TECHNIQUES / PENALITES	TIME TEMPS	SCORES	TECHNIQUES / PENALTIES TECHNIQUES / PENALITES	TIME TEMPS
GS			GS		

WINNER / VAINQUEUR	Ctry / Pays	SCORE / RESULTAT	CODE	TIME / TEMPS

N°	JUDGE JUGE	Ctry / Pays

N°	REFEREE / ARBITRE	Ctry / Pays

N°	JUDGE JUGE	Ctry / Pays

Signature of the representative of the IJF Sport Commission
Signature du représentant de la Commission Sportive de la FIJ

Direct Knockout

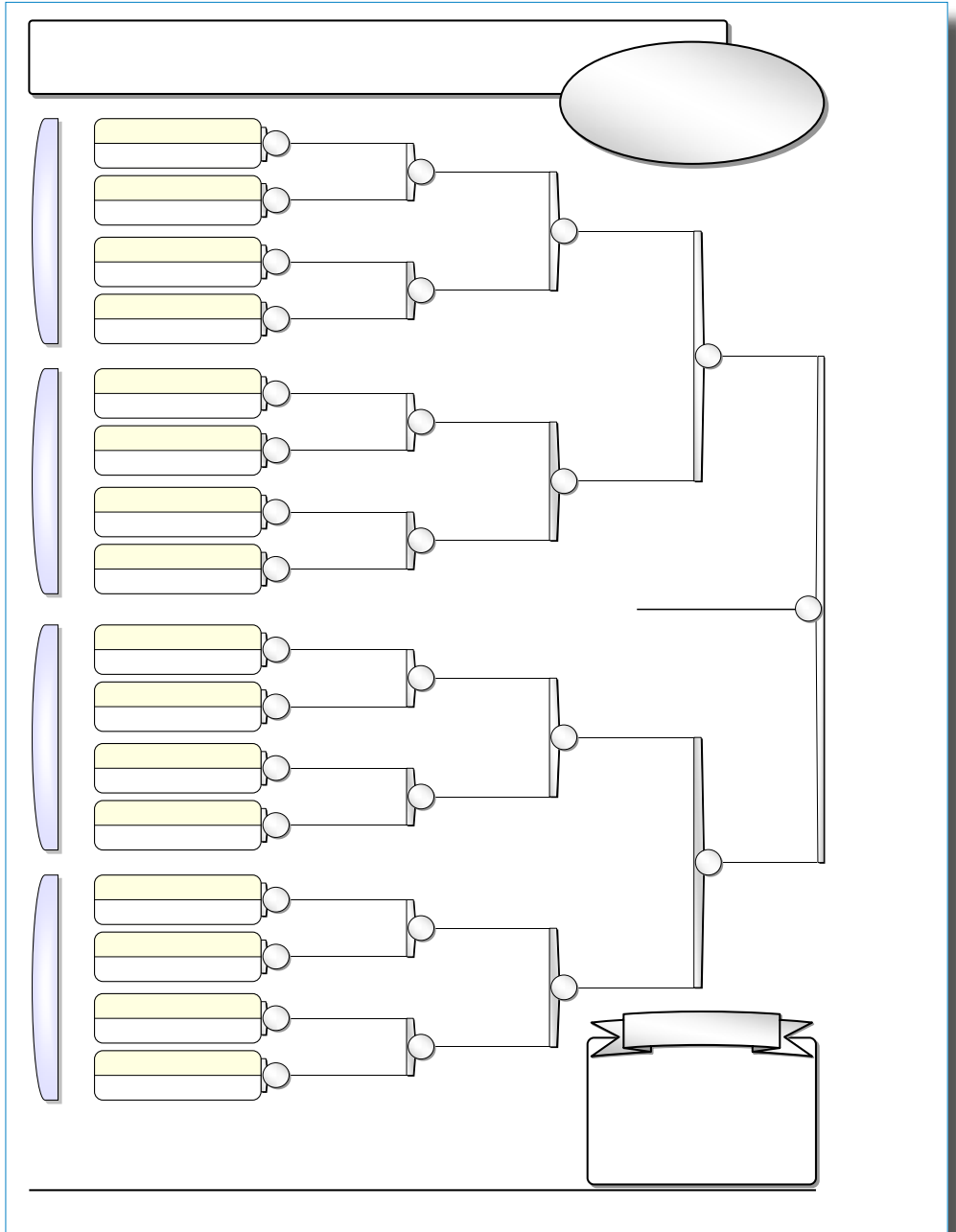

Quarter-Final Repechage

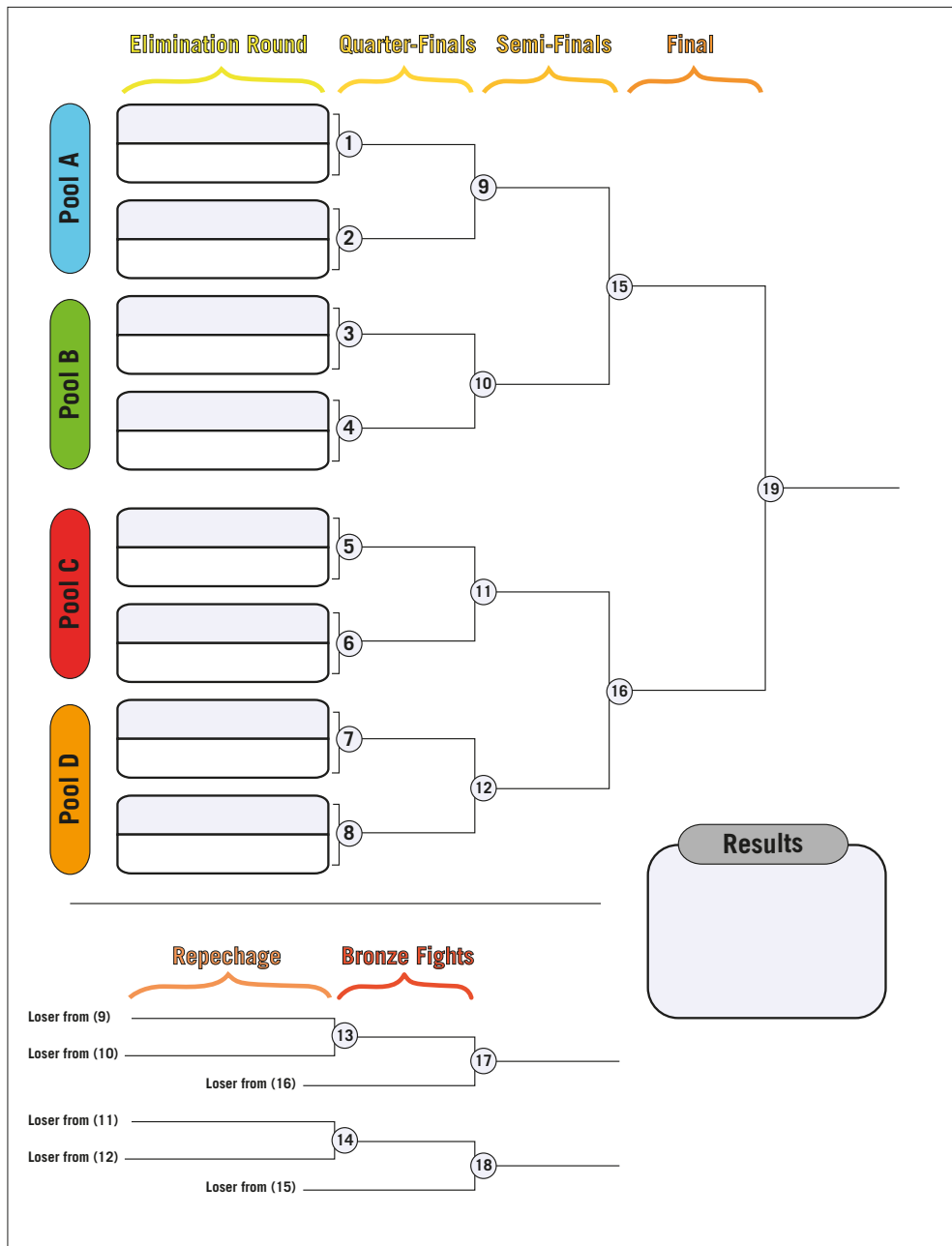

An Elimination System with Repechage Starting at the Quarter-Final (last 8)/up to 64 Athletes or Teams

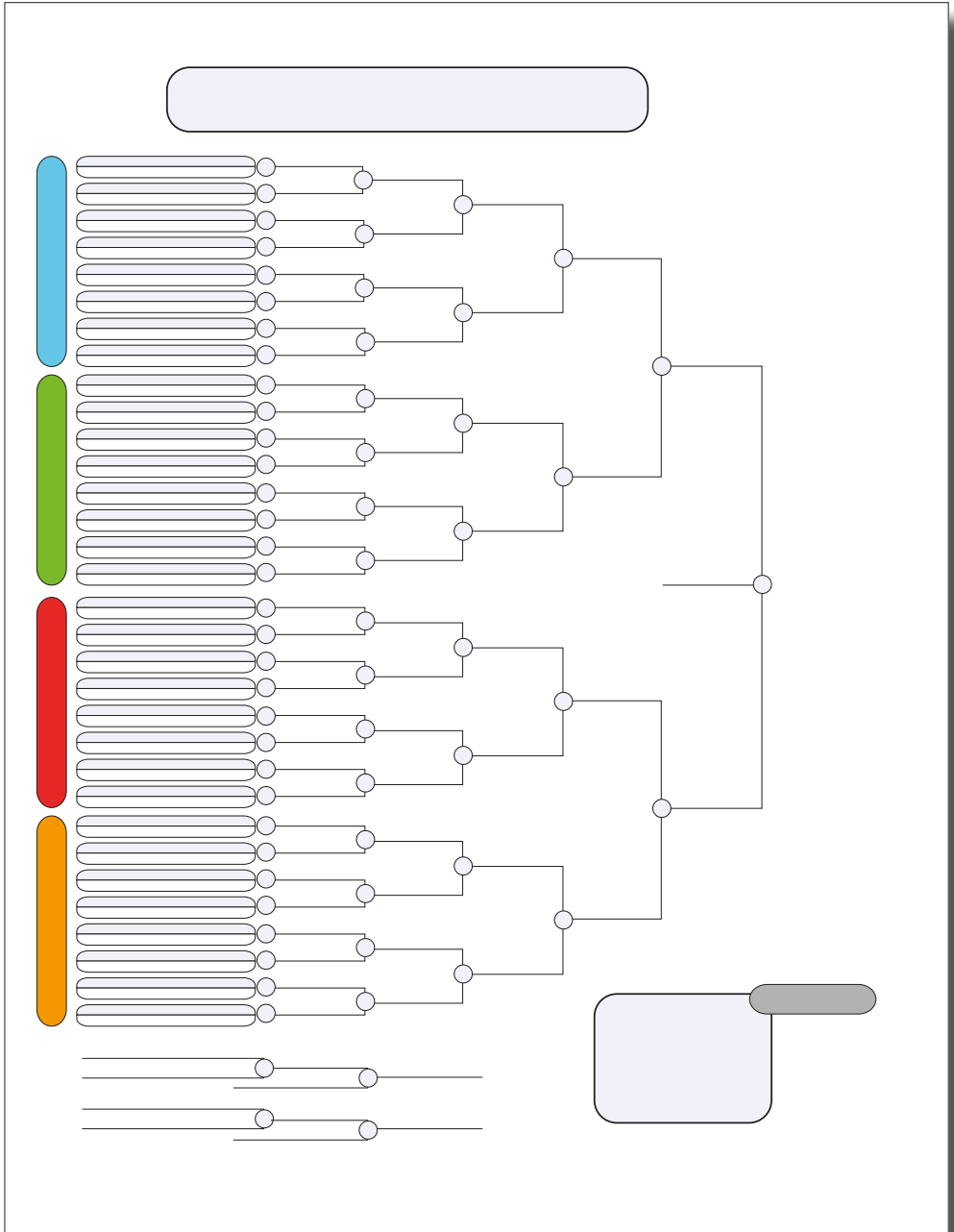

An Elimination System with Repechage Starting at the Quarter-Final (last 8)/up to 32 Athletes or Teams

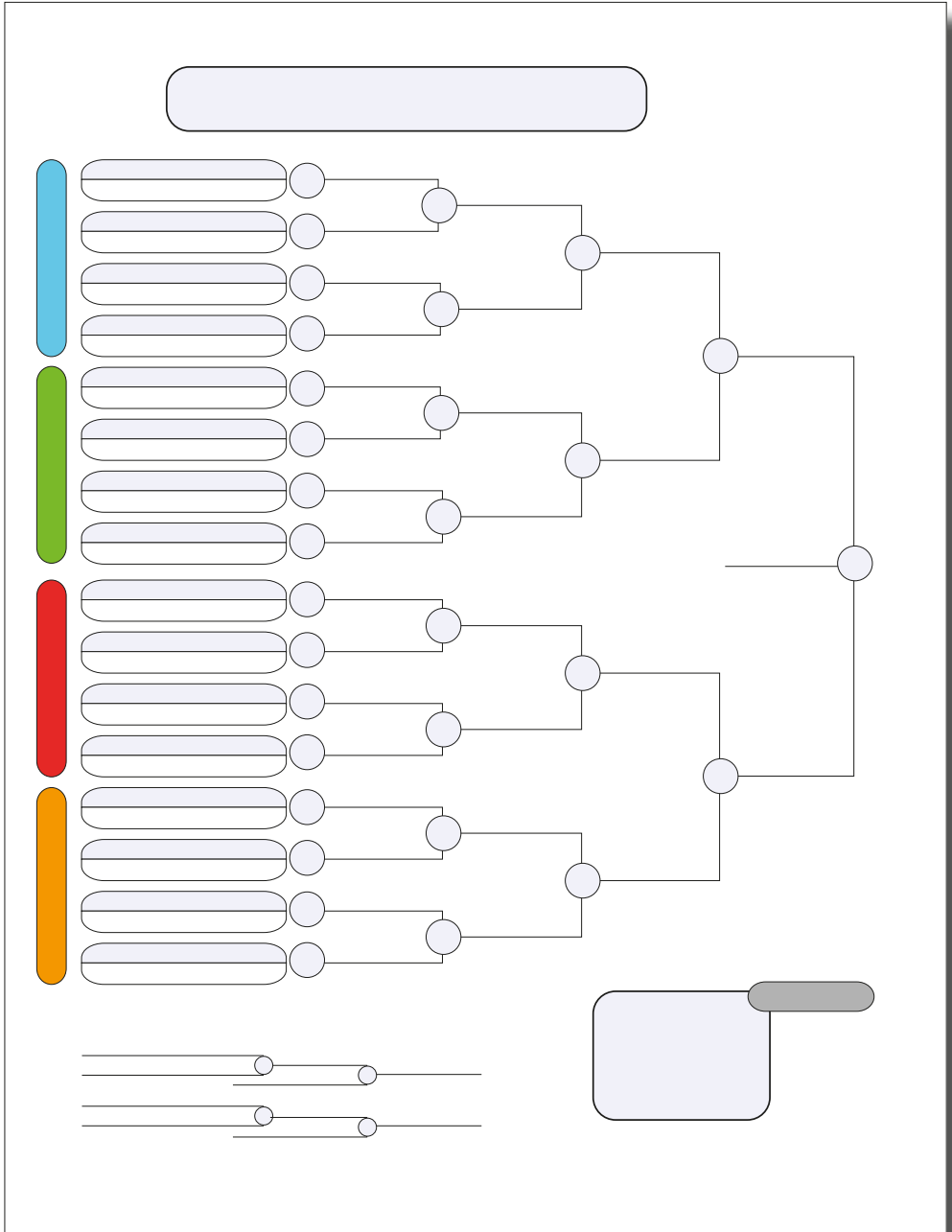

An Elimination System with Repechage Starting at the Quarter-Final (last 8)/up to 16 Athletes or Teams

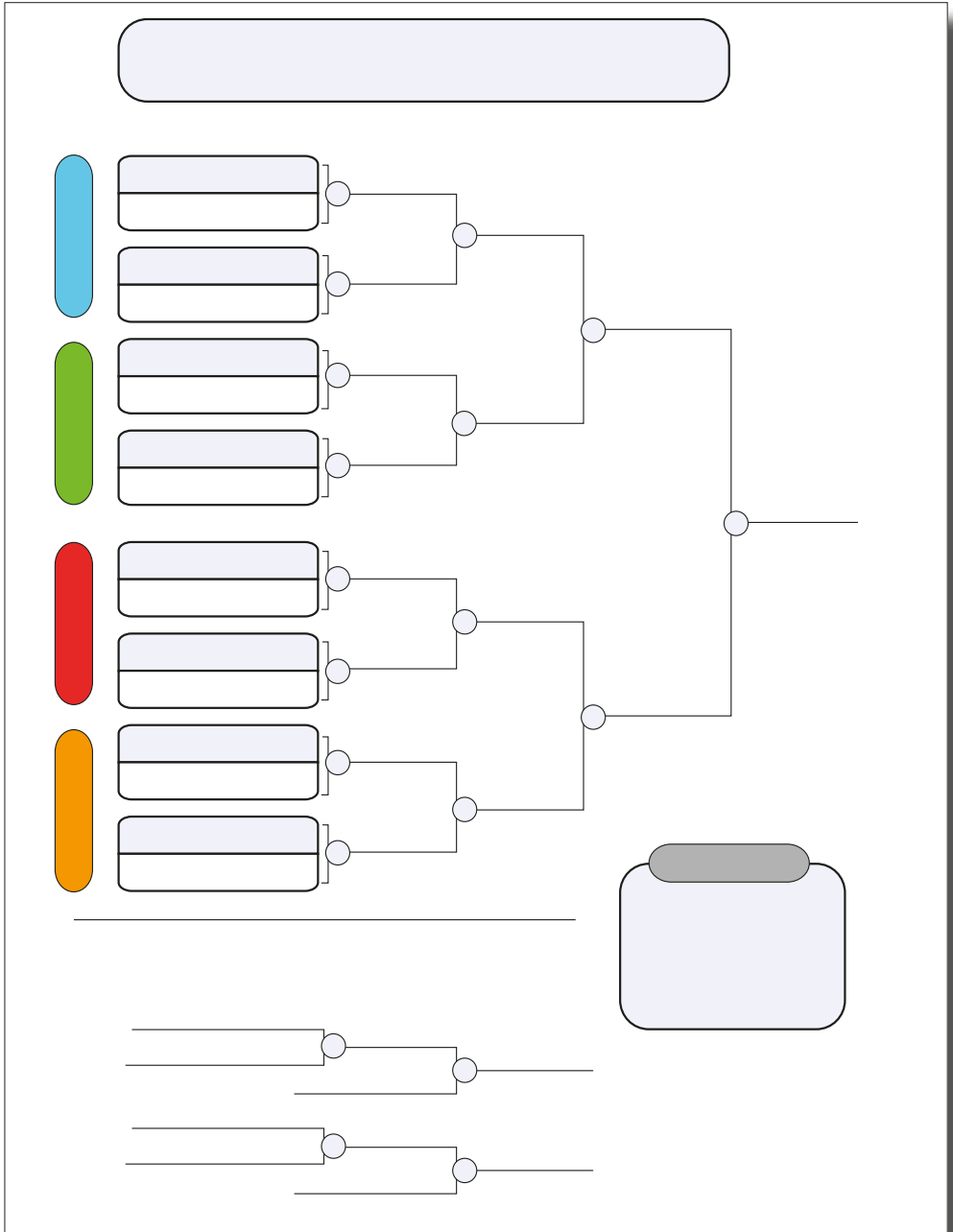

An Elimination System with Repechage Starting at the Quarter-Final (last 8)/up to 8 Athletes or Teams

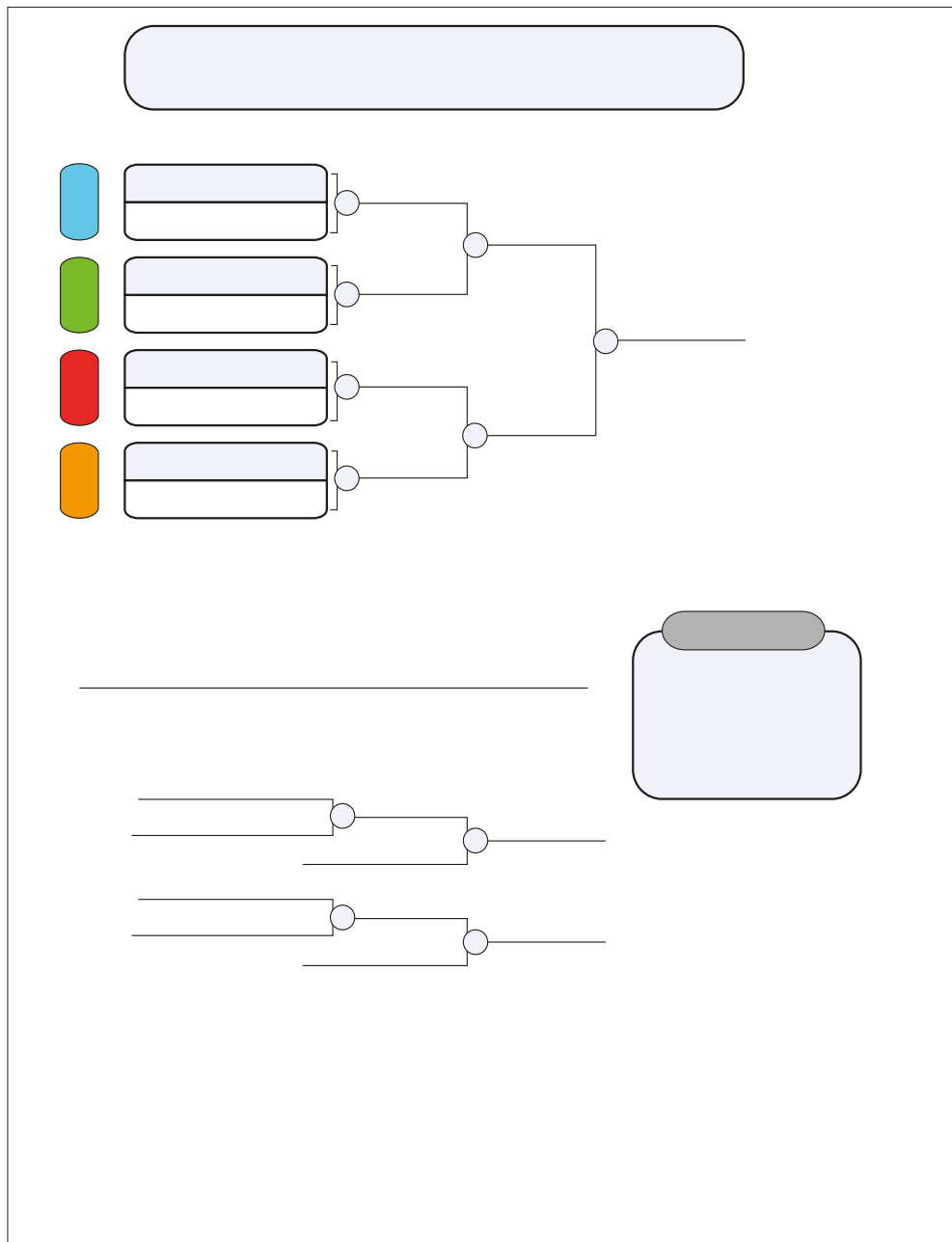

Double Repechage/up to 64 Athletes or Teams

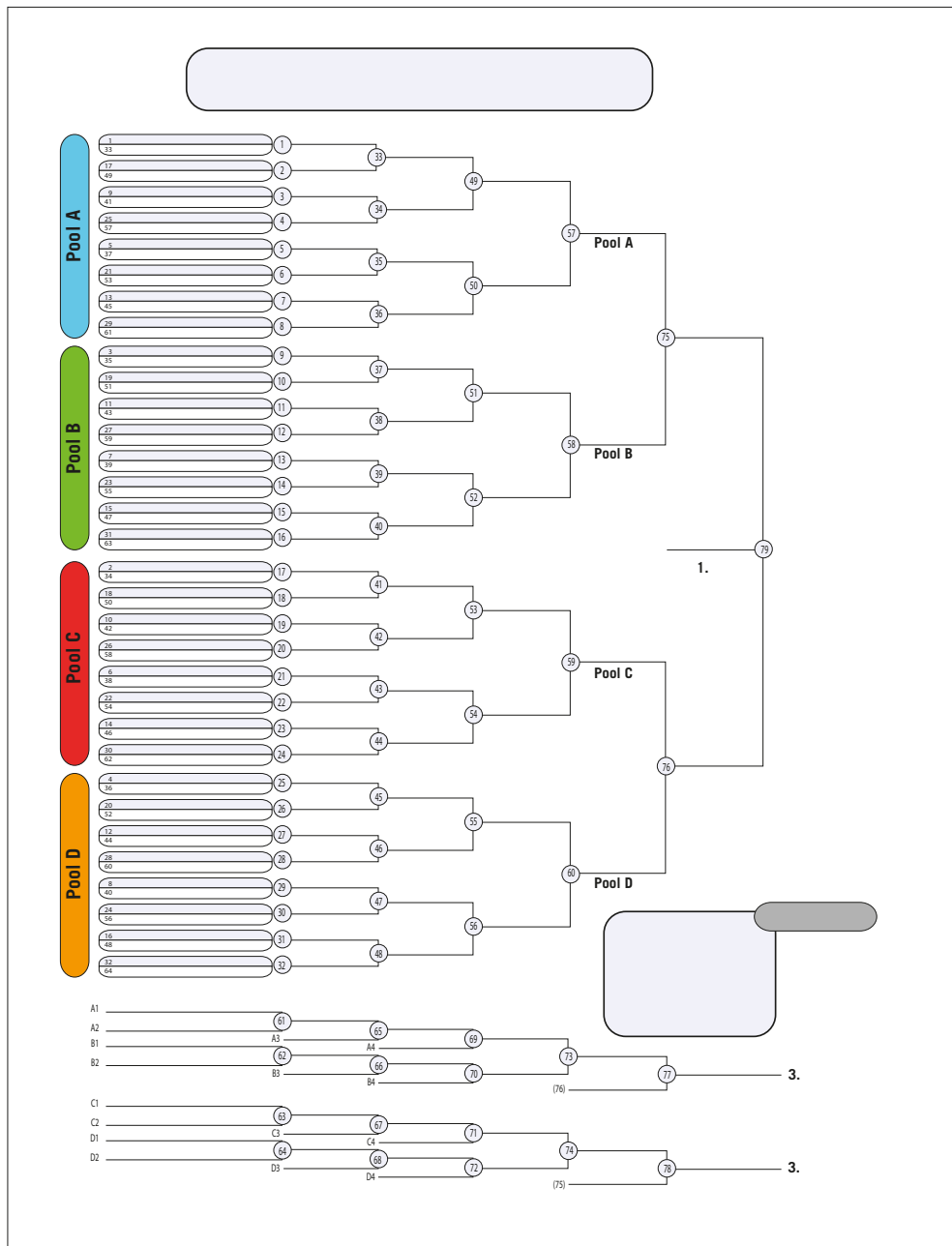

Double Repechage/up to 32 Athletes or Teams

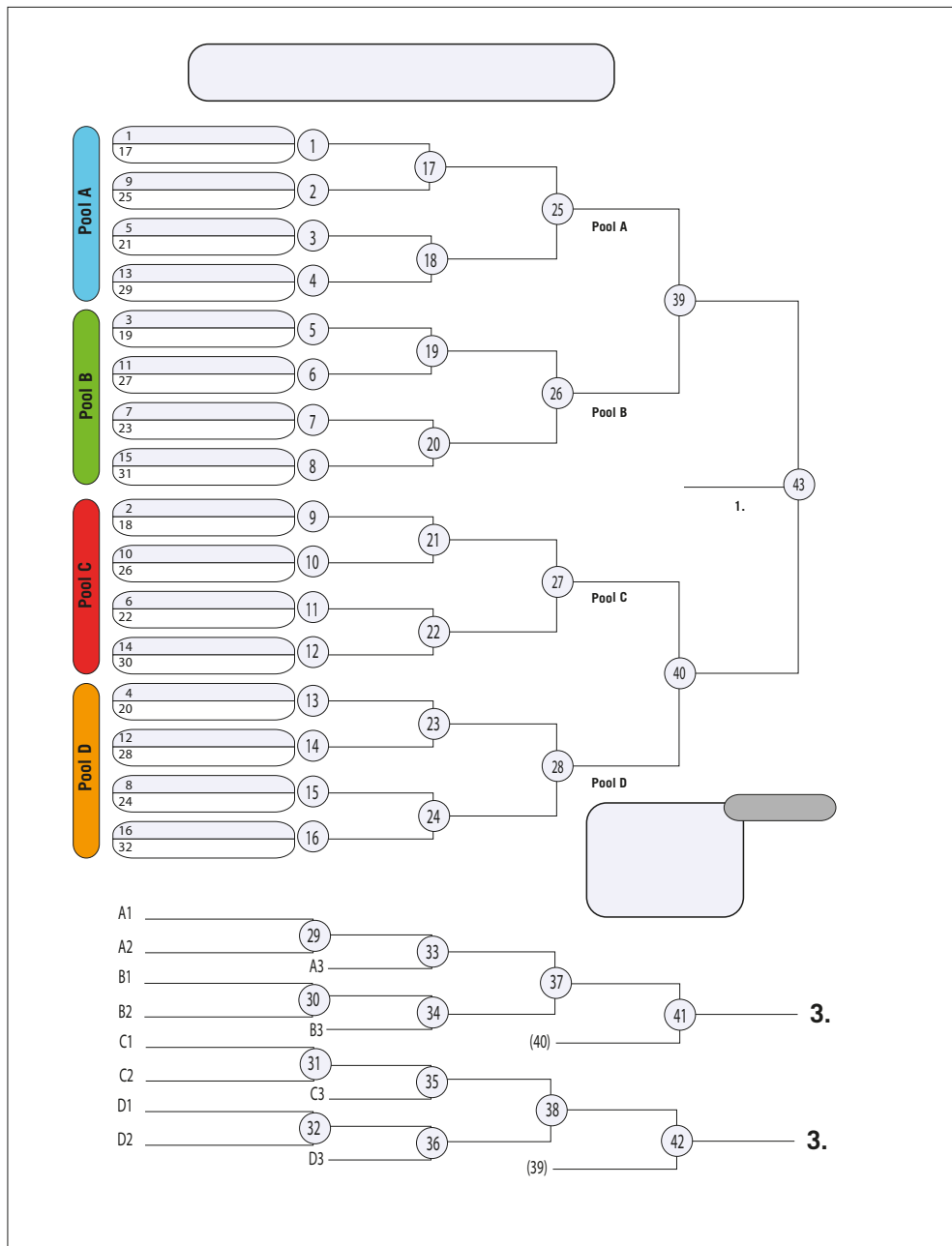

Double Repechage/up to 16 Athletes or Teams

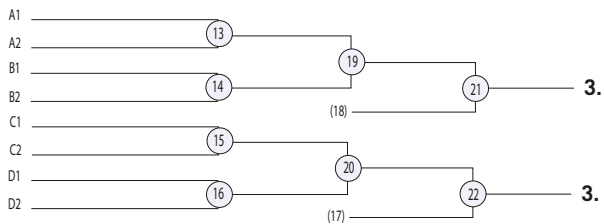
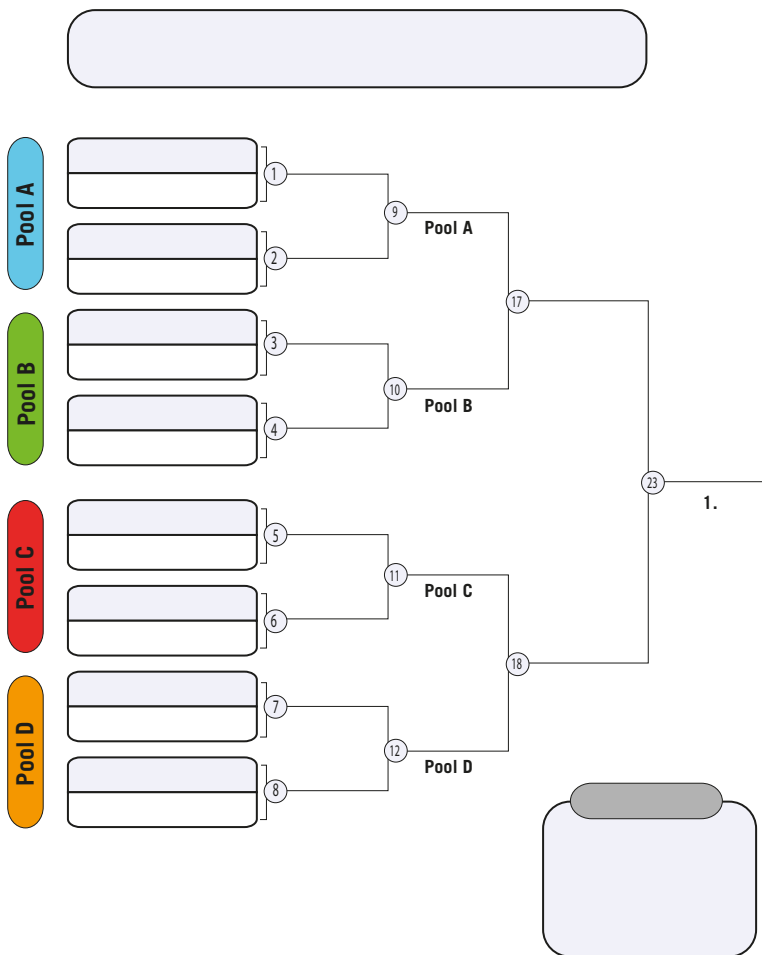

Double Repechage/up to 8 Athletes or Teams

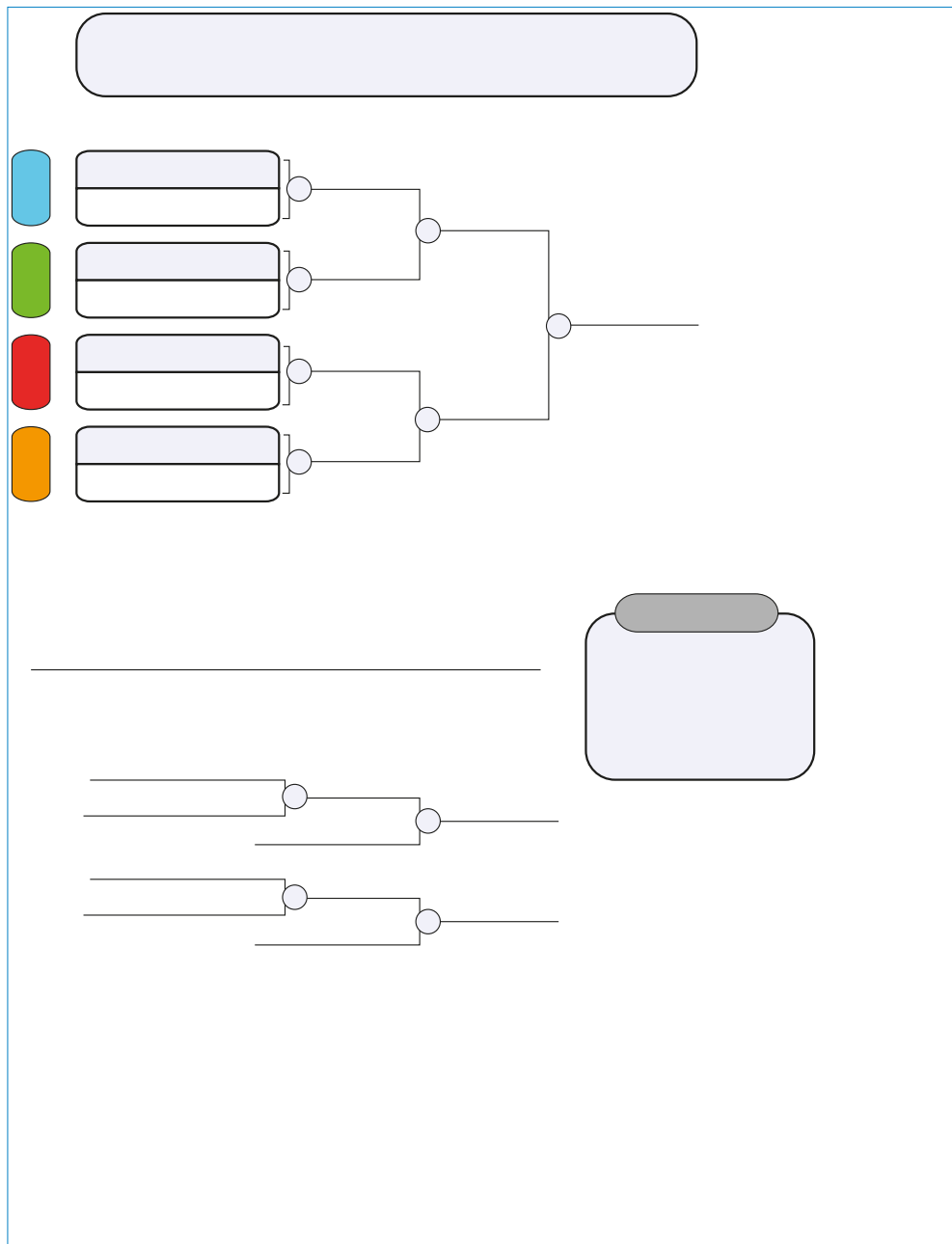

Full Repechage/up to 32 Athletes or Teams

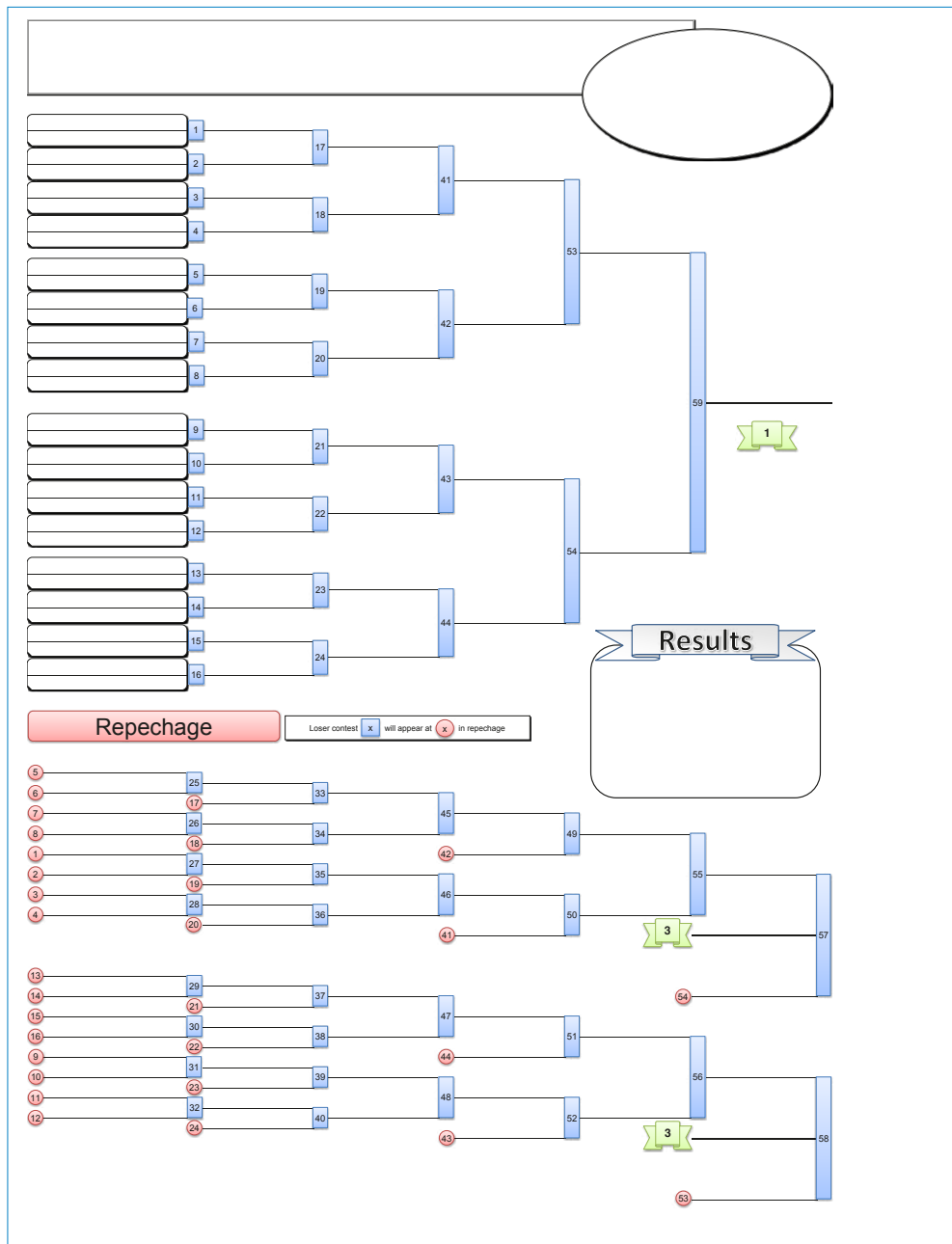

Full Repechage/up to 16 Athletes or Teams

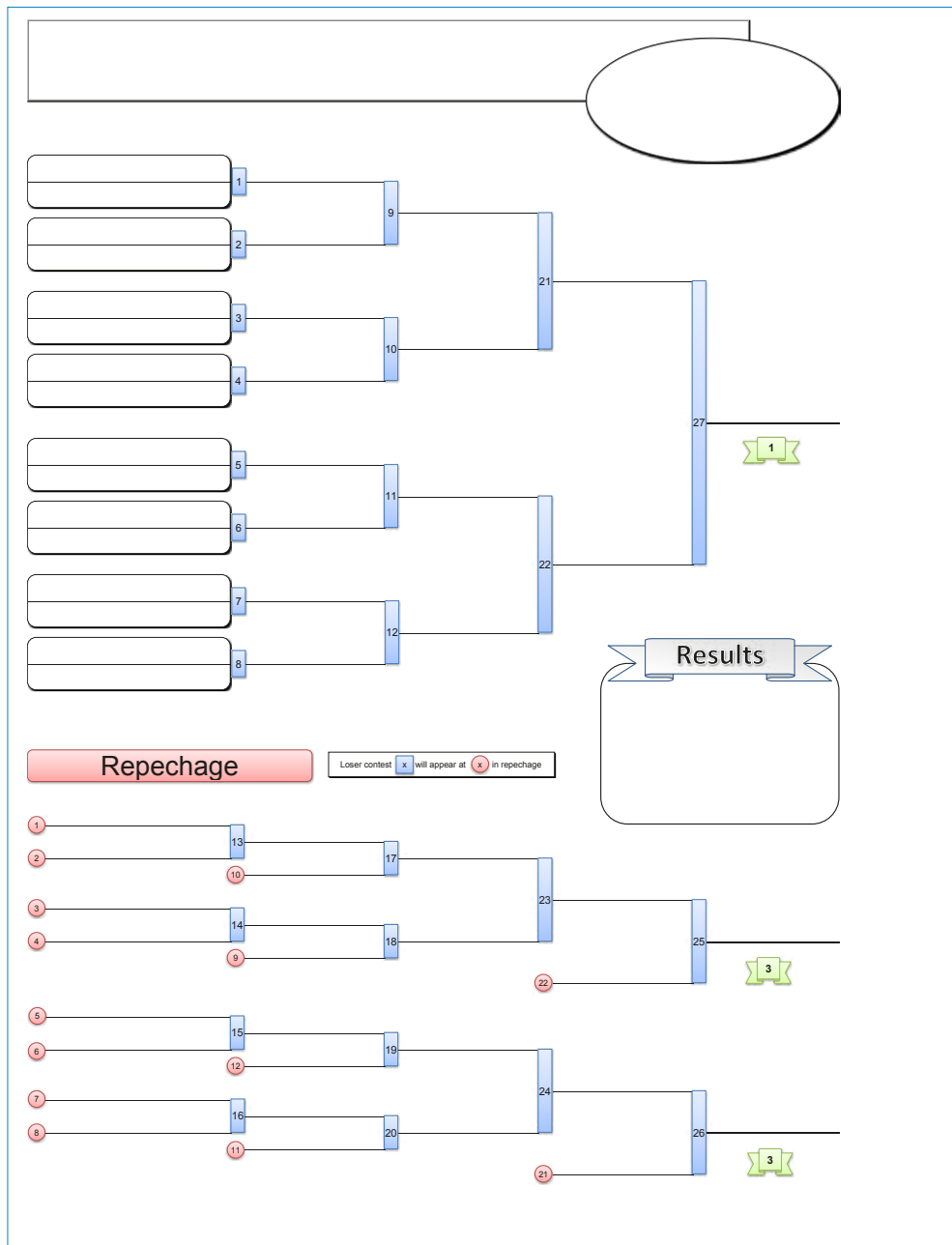

Five (5) Athletes or Teams - Option 1

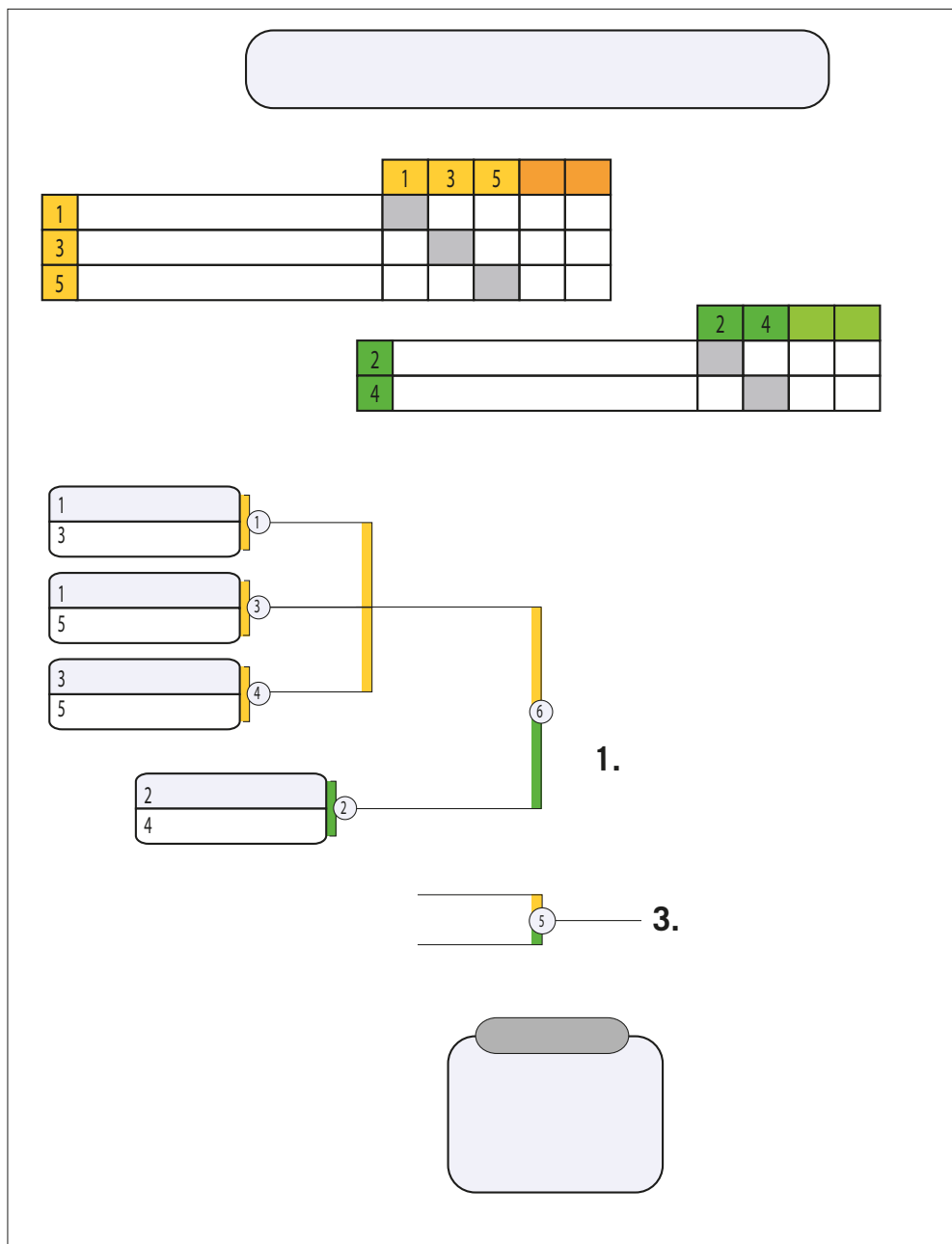

Five (5) Athletes or Teams - Option 2

	1	2	3	4	5		
1							
2							
3							
4							
5							

1

2

① _____

3

4

① _____

1

5

① _____

2

3

① _____

4

5

① _____

1

3

① _____

2

4

① _____

3

5

① _____

1

4

① _____

2

5

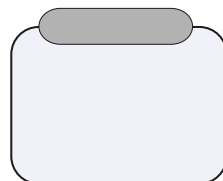
① _____

Four (4) Athletes or Teams - Option 1

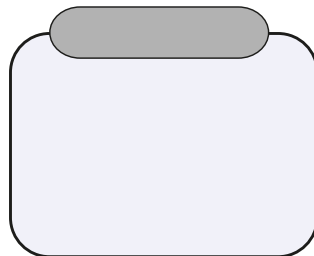
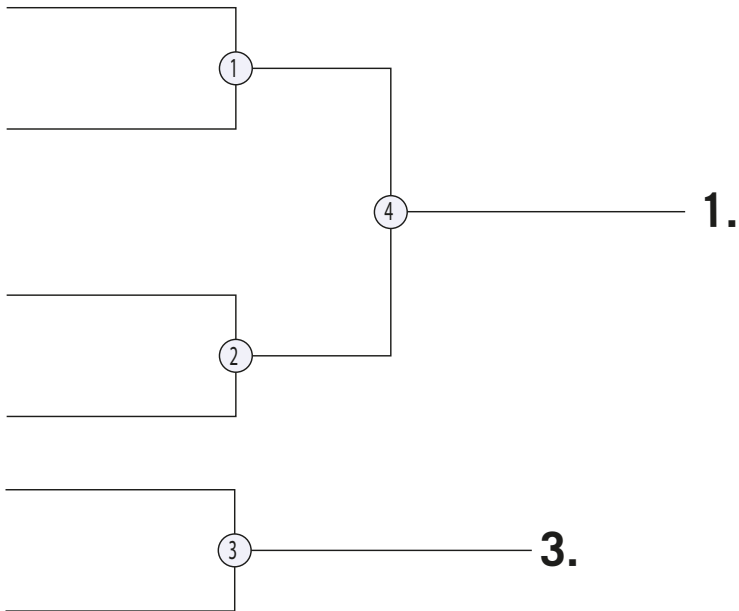

Four (4) Athletes or Teams - Option 2

	1	2	3	4		
1						
2						
3						
4						

1

2

① _____

3

4

② _____

1

3

③ _____

2

4

④ _____

1

4

⑤ _____

2

3

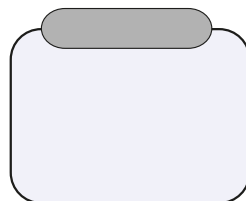
⑥ _____

Three (3) Athletes or Teams - Option 1



	1	2	3	4		
1						
2						
3						

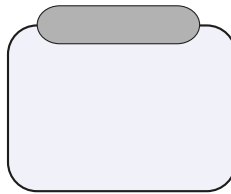
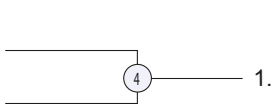
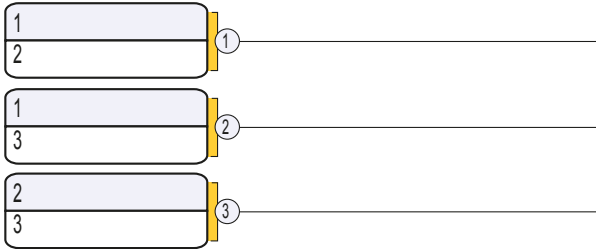

Three (3) Athletes or Teams - Option 2

	1	2	3	4		
1						
2						
3						

1
2

1

1
3

2

2
3

3

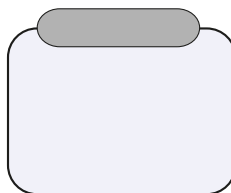

Example of Winners' List

Grand-Slam Tokyo 2013 Tokyo (JPN), 29 Nov - 01 Dec 2013		Men Final Results	
-60 kg			
1. TAKATO, Naohisa	JPN	1. TAKAJO, Tomofumi	JPN
2. KIM, Won Jin	KOR	2. CHIBANA, Charles	BRA
3. KIDO, Shinji	JPN	3. LAROSE, David	FRA
3. SHISHIME, Toru	JPN	3. MIYAZAKI, Ren	JPN
5. OASHIDA YAA, Amartuvshin	MGL	5. DRAGIN, Dimitri	FRA
6. SMETOV, Yeldos	KAZ	5. FUKUOKA, Masaaki	JPN
7. GANBAT, Boldbaatar	MGL	7. MARIUYAMA, Jوشيhiro	JPN
7. HUANG, Sheng-Ting	TPE	7. MUKANOV, Azamat	KAZ
-73 kg			
1. NAKAYA, Riki	JPN	1. NAGASE, Takenori	JPN
2. BANG, Gul-Man	KOR	2. PIETRI, Loic	FRA
3. DRAKSIC, Rok	SLO	3. NAKAI, Takahiro	JPN
3. IARTCEV, Denis	RUS	3. TCHIRKINSHVILI, Avtandil	GEO
5. DUPRAT, Pierre	FRA	5. HONG, Suk Woong	KOR
6. KHASHBAATAR, Tsagaanbaatar	MGL	5. STEVENS, Travis	USA
7. NAKAMURA, Takenori	JPN	7. MRVALJEVIC, Srdjan	MNE
7. POWBO DA SILVA, Alex William	BRA	7. NAGASHIMA, Keita	JPN
-90 kg			
1. BEIKER, Maszyu	JPN	1. KRPALEK, Lukas	CZE
2. Lee, Kyo-Won	KOR	2. REYES, Kyle	CAN
3. LIPARTELJANI, Varlam	GEO	3. MARET, Cyrille	FRA
3. NISHIYAMA, Daisi	JPN	3. NABDAN, Turzhinbayar	MOL
5. HILDEBRAND, Aaron	GER	5. PACEK, Martin	SWE
6. SHIMOWADA, Shohei	JPN	5. RAKOV, Maxim	KAZ
7. SULJEMIN, Grigori	RUS	7. KUMASHIRO, Yusuke	JPN
7. ZARZECZNY, Jakub	POL	7. SAMOLOVICH, Sergei	RUS
+100 kg			
1. KIM, Sump-Min	KOR		
2. SILVA, Rafael	BRA		
3. HARASAWA, Hisayoshi	JPN		
3. MOROSE, Masaru	JPN		
6. BONVOISIN, Jean-Sebastien	FRA		
6. SHICHINOHE, Ryu	JPN		
7. KIM, Soo-Whan	KOR		
7. MOURA, David	BRA		

Page 1/2

www.ijf.org (c) International Judo Federation IJF

15-Jan-2014 - 15:45:52

Grand-Slam Tokyo 2013 Tokyo (JPN), 29 Nov - 01 Dec 2013		Women Final Results	
-48 kg			
1. KONDO, Aimi	JPN	1. HASHIMOTO, Yuki	JPN
2. BURKHVAT, Urantsetseg	MGL	2. IRRANDA, Erica	BRA
3. MENEZES, Sarah	BRA	3. CHITU, Andrea	ROU
3. YAMAGISHI, Emi	JPN	3. SHISHIME, Ai	JPN
5. RUMYANTSEVA, Kristina	RUS	5. SUNDBERG, Jaana	FIN
5. TODA, Miki	JPN	5. VALENTIN, Elisavita	BRA
7. CHERNAK, Maryna	UKR	7. DELGADO, Angelica	USA
7. LABORDRE, Maria Celia	CUB	7. GOMI, Natsumi	JPN
-52 kg			
-57 kg			
1. UDAKA, Nae	JPN	1. ABE, kana	JPN
2. MALLOY, Marti	USA	2. TASHIRO, Miku	JPN
3. DEGUCHI, Christa	JPN	3. JOUNG, Da-Woon	KOR
3. YAMAMOTO, Anzu	JPN	3. TANAKA, Miki	JPN
5. QUADROS, Kellieyn	BRA	5. BARRROS, Mariana	BRA
5. SILVA, Raebela	BRA	5. BELLARD, Anne-Laure	FRA
7. CAPRIORIU, Corina	ROU	7. CAMPOS, Katherine	BRA
7. ROPER, Miryam	GER	7. VAN EMDEN, Anicka	NEO
-63 kg			
-70 kg			
1. ARAI, Chizuru	JPN	1. VERKERK, Marhinde	NEO
2. POLLING, Kim	NEO	2. JONG, Gyeong-Mi	KOR
3. ALVEAR, Yuki	COL	3. OKAMURA, Tomomi	JPN
3. KIM, Seongyeon	KOR	3. SATO, Ruita	JPN
5. MARZOK, Iijana	GER	5. MALZAHN, Lutse	GER
5. TACHIBANO, Haruka	JPN	5. THIELLE, Kerstin	GER
7. CONWAY, Sally	GBR	7. TURKS, Victoria	UKR
7. GAZIEVA, Irina	RUS	7. WANG, Szu-Chu	TPE
+78 kg			
1. TACHIBANO, Megumi	JPN		
2. YAMABE, Kenae	JPN		
3. ORTIZ, Idalya	CUB		
3. QIN, Qian	CHN		
5. ASAHINA, Sara	JPN		
5. MA, Siel	CHN		
7. LEE, Jung Eun	KOR		
7. NUNES, Rochele	BRA		

Page 2/2

www.ijf.org (c) International Judo Federation IJF

15-Jan-2014 - 15:45:52



Example of Team Line Up Confirmation

	Line-up confirmation Team World Championship Juniors 2013	Tatami: II JPN Men Bronze #18
--	---------------------------------------------------------------------	---------------------------------------------------

Round:	Men Bronze
Match:	JAPAN - SLOVENIA

		Family name	Given name	original category
-66 kg	<input type="checkbox"/>	HASHIGUCHI	Yuuki	-66 kg
	<input type="checkbox"/>	TATEYAMA	Sho	-66 kg
	<input type="checkbox"/>	< no competitor >		-
-73 kg	<input type="checkbox"/>	IWABUCHI	Yusai	-73 kg
	<input type="checkbox"/>	HASHIGUCHI	Yuuki	-66 kg
	<input type="checkbox"/>	TATEYAMA	Sho	-66 kg
	<input type="checkbox"/>	< no competitor >		-
-81 kg	<input type="checkbox"/>	KOHARA	Kenya	-81 kg
	<input type="checkbox"/>	IWABUCHI	Yusai	-73 kg
	<input type="checkbox"/>	< no competitor >		-
-90 kg	<input type="checkbox"/>	KOBAYASHI	Yusuke	-90 kg
	<input type="checkbox"/>	KOHARA	Kenya	-81 kg
	<input type="checkbox"/>	< no competitor >		-
+90 kg	<input type="checkbox"/>	KURAHASHI	Isao	+90 kg
	<input type="checkbox"/>	SATO	Kazuya	+90 kg
	<input type="checkbox"/>	KOBAYASHI	Yusuke	-90 kg
	<input type="checkbox"/>	< no competitor >		-

Please mark for each category the selected /
 If you need to make corrections please use a new sheet.

	Team World Championship Juniors 2013	SLO Men Bronze #18
--	---------------------------------------------	------------------------------

Round:	Men Bronze
Match:	JAPAN - SLOVENIA

		Family name	Given name	original category
-66 kg	<input type="checkbox"/>	GOMBOC	Adrian	-66 kg
	<input type="checkbox"/>	KURALT	Luka	-66 kg
	<input type="checkbox"/>	< no competitor >		-
-73 kg	<input type="checkbox"/>	HOJAK	Marin	-73 kg
	<input type="checkbox"/>	POTPARIC	Igor	-73 kg
	<input type="checkbox"/>	GOMBOC	Adrian	-66 kg
	<input type="checkbox"/>	KURALT	Luka	-66 kg
<input type="checkbox"/>	< no competitor >		-	
-81 kg	<input type="checkbox"/>	MARINCIC	Primoz	-81 kg
	<input type="checkbox"/>	VOLCIC	David	-81 kg
	<input type="checkbox"/>	HOJAK	Marin	-73 kg
	<input type="checkbox"/>	POTPARIC	Igor	-73 kg
<input type="checkbox"/>	< no competitor >		-	
-90 kg	<input type="checkbox"/>	MULEC	Tadej	-90 kg
	<input type="checkbox"/>	ZGANK	Mihael	-90 kg
	<input type="checkbox"/>	MARINCIC	Primoz	-81 kg
	<input type="checkbox"/>	VOLCIC	David	-81 kg
<input type="checkbox"/>	< no competitor >		-	
+90 kg	<input type="checkbox"/>	DRAGIC	Vito	+90 kg
	<input type="checkbox"/>	POLAJZER	Rok	+90 kg
	<input type="checkbox"/>	MULEC	Tadej	-90 kg
	<input type="checkbox"/>	ZGANK	Mihael	-90 kg
	<input type="checkbox"/>	< no competitor >		-

Please mark for each category the selected player.
 If you need to make corrections please use a new sheet.

Please confirm that above names and categories are correct and complete.
 Veuillez vérifier et confirmer que les noms et les poids sont corrects et complets.
 Favor confirmar que la información de los competidores así como los datos de siembra son correctos y completos.

X _____
 Signature team leader

Submission time	Official	Validated	Published
-----------------	----------	-----------	-----------

Example of Mixed Team Line Up Confirmation

Line-up confirmation
 Suzuki World Championship Teams 2017

Tatami: I
CRO
 Second Round #22

Round:	Second Round
Match:	GEORGIA - CROATIA

		Family name	Given name	original category
-57 kg	<input type="checkbox"/>	SIKIC	Tina	-57 kg
	<input type="checkbox"/>	TOPOLOVEC	Tina	-57 kg
		< no competitor >		
-73 kg	<input type="checkbox"/>	AZINOVIC	Bernard	-73 kg
	<input type="checkbox"/>	SUMPCOR	Dominic	-73 kg
		< no competitor >		
-70 kg	<input type="checkbox"/>	MATIC	Barbara	-70 kg
	<input type="checkbox"/>	SIKIC	Tina	-57 kg
		TOPOLOVEC	Tina	-57 kg
		< no competitor >		
-90 kg	<input type="checkbox"/>	DRUZETA	Dominik	-90 kg
	<input type="checkbox"/>	AZINOVIC	Bernard	-73 kg
		SUMPCOR	Dominic	-73 kg
		< no competitor >		
+70 kg	<input type="checkbox"/>	SUTALO	Ivana	+70 kg
	<input type="checkbox"/>	MATIC	Barbara	-70 kg
		< no competitor >		
+90 kg	<input type="checkbox"/>	KUMRIC	Marko	+90 kg
	<input type="checkbox"/>	KUMRIC	Zlatko	+90 kg
		DRUZETA	Dominik	-90 kg
		< no competitor >		

Please mark for each category the selected player.
 If you need to make corrections please use a new sheet.

Please confirm that above names and categories are correct and complete. X
 Veuillez vérifier et confirmer que les noms et les poids sont corrects et complets.
 Favor confirmar que la información de los competidores así como los datos de sientas son correctos y completos. _____
 Signature team leader

Submission time	Official	Validated	Published

Line-up confirmation
 Suzuki World Championship Teams 2017

Tatami: I
GEO
 Second Round #22

Round:	Second Round
Match:	GEORGIA - CROATIA

		Family name	Given name	original category
-57 kg	<input type="checkbox"/>	JANASHVILI	Mariam	-57 kg
	<input type="checkbox"/>	< no competitor >		
-73 kg	<input type="checkbox"/>	GIUNASHVILI	Lasha	-73 kg
	<input type="checkbox"/>	MARGVELASHVILI	Vazha	-73 kg
		< no competitor >		
-70 kg	<input type="checkbox"/>	ODZELASHVILI	Nino	-70 kg
	<input type="checkbox"/>	STAM	Esther	-70 kg
		JANASHVILI	Mariam	-57 kg
		< no competitor >		
-90 kg	<input type="checkbox"/>	GVINASHVILI	Beka	-90 kg
	<input type="checkbox"/>	TCHRIKISHVILI	Avtandil	-90 kg
		GIUNASHVILI	Lasha	-73 kg
		MARGVELASHVILI	Vazha	-73 kg
		< no competitor >		
+70 kg	<input type="checkbox"/>	KEBADZE	Elene	+70 kg
	<input type="checkbox"/>	ODZELASHVILI	Nino	-70 kg
		STAM	Esther	-70 kg
		< no competitor >		
+90 kg	<input type="checkbox"/>	OKRUIASHVILI	Adam	+90 kg
	<input type="checkbox"/>	TUSHISHVILI	Guram	+90 kg
		GVINASHVILI	Beka	-90 kg
		TCHRIKISHVILI	Avtandil	-90 kg
		< no competitor >		

Please mark for each category the selected player.
 If you need to make corrections please use a new sheet.

Please confirm that above names and categories are correct and complete. X
 Veuillez vérifier et confirmer que les noms et les poids sont corrects et complets.
 Favor confirmar que la información de los competidores así como los datos de sientas son correctos y completos. _____
 Signature team leader

Submission time	Official	Validated	Published



Example of Team Sheet - with Results

Team Sheet

World Team Championship Juniors 2015

**Tatami: II
Men**

Bronze #18

Category	BLR	Scores		Wins	Wins	Scores		UZB	Duration
		I	W			P	I		
-66 kg	MINKOU, Dzmitry		1	2	1	0		MATYAKUBOV, Azamat	4:00
-73 kg	KLEBCHA, Hryhory		0	2	1	1		SHOMURODOV, Sarvar	4:00
-81 kg	VARAPAYEU, Yahor		1	1	1	0		BOBONOV, Davlat	1:01
-90 kg	MUKETE, Daniel		1	3	1	0		KHURRAMOV, Mukhammadkarim	2:14
+90 kg	SVIRYD, Mikita		0	1	1	1		BAHODURZODA, Azamat	1:01
Result	Winner: Belarus		3		2				

Team and Date	Signature Official	Signature Sports Director	Remark

Example of Mixed Team Sheet



Match Sheet

Suzuki World Championship Teams 2017

**Tatami: I
Mixed**

Second Round #23

Category	GEO	Scores	Wins	Wins	Scores	CRO	Duration
-57 kg	JANASHVILI, Mariam	I W P			I W P	TOPOLOVEC, Tihea	
-73 kg	MARGVELASHVILI, Vazha	I W P			I W P	SUMPOR, Dominic	
-70 kg	STAM, Esther	I W P			I W P	MATIC, Barbara	
-90 kg	TCHRIKISHVILI, Avtandili	I W P			I W P	DRUZETA, Dominik	
+70 kg	KEBADZE, Elene	I W P			I W P	SUTALO, Ivana	
+90 kg	TUSHISHVILI, Guram	I W P			I W P	KUMRIC, Zlatko	
Result							

Date and Day	Signature Official	Signature Sports Director	Remark





GLOSSARY

Approved by the Kodokan

H1.1 Glossary of Japanese Terms

Japanese	English
Anza	Sitting cross-legged
Ashi-waza	Foot or leg throw
Atemi-waza	Striking techniques
Awase-waza	Combination of two waza-ari
Dani	Dan grade
Dojo	Training hall
Encho-sen	Extended contest
Fuku-shin	Assistant referee / Table judge
Fusen-gachi	Win by default (e.g. D.N.A)
Haisha	Loser
“Hajime!”	“Start!”
Hansoku	Foul
Hansoku-make	Defeat by grave infringement or accumulated light infringements
Hazumi	Skillfulness with impetus, sharpness or rhythm
Henka-waza	Techniques against opponent's attack
Hidari-jigo-tai	Left lower posture
Hidari-shizen-tai	Left natural posture
Hiki-te	Pulling hand
Hikiwake	Draw
Ikioi	Momentum with both force and speed
Ippon	Complete point
Jigo-hon-tai	Straight lower posture
Jigo-tai	Lower posture
Jiku-ashi	Pivot leg
Jo-gai	Outside contest area
Jo-nai	Inside contest area
Jo-seki	Upper Seats
Judo-gi	Judo uniform
Kachi	Win
Kaeshi-waza	Counter techniques



Kake	Execution of throwing techniques
Kansetsu-waza	Joint locks
Kappo	Resuscitation method
Kata	Forms
Katame-waza	Grappling techniques
Katsu	Techniques of Kappo
Keiko	Training / Practice
Kiken-gachi	Win by withdrawal
Kime	Complete execution
Kin-sa	Slight superiority or inferiority
Kinshi-waza	Prohibited techniques
“Kio-tsuke!”	“Attention!” (Words of command to make the person stand straight up with closed heels)
Koshi-waza	Hip throw
Kowa	Lecture
Kumi-te	Grips hold
Kumi-kata	Method of grips hold
Kuzushi	Balance breaking
Kyu-sho	Vital points
Maai	Distance between two players
“Maitta !”	“I give up!”
Ma-sutemi-waza	Supine sacrifice throw
“Mate!”	Wait
Migi-jigo-tai	Right lower posture
Migi-shizen-tai	Right natural posture
Mondo	Questions and answers
Nagekomi	Repetitive throwing practice
Nage-waza	Throwing techniques
Ne-shisei	Ground position
Ne-shobu	Ground battle
Ne-waza	Ground works
Osaekomi-waza	Hold down techniques
“Osaekomi!”	“Hold is on!”
“Otagai-ni-rei!”	“Bow to each other!”



Randori	Free sparring
Renraku-waza	Combination of several techniques
Renzoku-waza	Repetition of the same technique
Rei	Courtesy
“Rei!”	“Bow!”
Rei-ho	Method of Courtesy / Bowing procedure
Riai	Theory and principle
Ritsu-rei	Standing bow
Seiza	Sitting square / Formal sitting
Shiai	Contest
Shiai-jo	Competition area
Shido	Instruction / Light penalty
Shime-waza	Strangling techniques
Shimpan	Refereeing
Shimpan-in	Referees and judges
Shisei	Posture
Shizen-tai	Natural posture
Shizen-hon-tai	Straight natural posture
Shomen	Dojo front / Upper Seats
“Shomen-ni-rei!”	“Bow towards Shomen!”
Shosha	Winner
Shu-shin	Chief referee / Mat referee
“Sono-mama!”	“Do not move / Hold positions!”
“Sore-made!”	“Time is up!”
Sutemi-waza	Sacrifice throw
Tachi-shisei	Standing position
Tachi-shobu	Standing battle
Tachi-waza	Standing throw
Tai-sabaki	Body shifting / Body control
Tatami	Straw mat
Te-waza	Hand throw
“Toketa!”	“Hold-down broken!”
Tori	Player executing technique
Tsukuri	Set-up to execute technique



Tsuri-te	Lifting hand
Uchikomi	Repetition training
Ude-gaeshi	Arm locking throw / Arm reverse
Uke	Player receiving opponent's attack
Ukemi	Break fall
Waza	Techniques
Waza-ari	Near Ippon
"Waza-ari-awasete-Ippon!"	"Two waza-ari score Ippon!"
Yakusoku-renshu	Agreed-upon practice
Yoko-sutemi-waza	Side sacrifice throw
"Yoshi!"	"Resume!"
Yusei-gachi	Win by superior performance
Za-rei	Seated bow

H1.2 Names of Judo Techniques

Nage-waza (68)

Te-waza		
1	Seoi-nage	SON
2	Ippon-seoi-nage	ISN
3	Seoi-otoshi	SOO
4	Tai-otoshi	TOS
5	Kata-guruma	KGU
6	Sukui-nage	SUK
7	Obi-otoshi	OOS
8	Uki-otoshi	UOT
9	Sumi-otoshi	SOT
10	Yama-arashi	YAS
11	Obi-tori-gaeshi	OTG
12	Morote-gari	MGA
13	Kuchiki-taoshi	KTA
14	Kibisu-gaeshi	KIG
15	Uchi-mata-sukashi	UMS
16	Kouchi-gaeshi	KOU

Koshi-waza		
1	Uki-goshi	UGO
2	O-goshi	OGO
3	Koshi-guruma	KOG
4	Tsurikomi-goshi	TKG
5	Sode-tsurikomi-goshi	STG
6	Harai-goshi	HRG
7	Tsuri-goshi	TGO
8	Hane-goshi	HNG
9	Utsuri-goshi	UTS
10	Ushiro-goshi	USH



Ashi-waza		
1	De-ashi-harai	DAB
2	Hiza-guruma	HIZ
3	Sasae-tsurikomi-ashi	STA
4	O-soto-gari	OSG
5	O-uchi-gari	OUG
6	Ko-soto-gari	KSG
7	Ko-uchi-gari	KUG
8	Okuri-ashi-harai	OAB
9	Uchi-mata	UMA
10	Ko-soto-gake	KSK
11	Ashi-guruma	AGU
12	Harai-tsurikomi-ashi	HTA
13	O-guruma	OGU
14	O-soto-guruma	OGR
15	O-soto-otoshi	OSO
16	Tsubame-gaeshi	TSU
17	O-soto-gaeshi	OGA
18	O-uchi-gaeshi	OUC
19	Hane-goshi-gaeshi	HGG
20	Harai-goshi-gaeshi	HGE
21	Uchi-mata-gaeshi	UMG

Ma-sutemi-waza		
1	Tomoe-nage	TNG
2	Sumi-gaeshi	SUG
3	Hikikomi-gaeshi	HKG
4	Tawara-gaeshi	TWG
5	Ura-nage	UNA

Yoko-sutemi-waza		
1	Yoko-otoshi	YOT
2	Tani-otoshi	TNO
3	Hane-makikomi	HNM
4	Soto-makikomi	SMK
5	Uchi-makikomi	UMK
6	Uki-waza	UWA
7	Yoko-wakare	YWA
8	Yoko-guruma	YGU
9	Yoko-gake	YGA
10	Daki-wakare	DWK
11	O-soto-makikomi	OSM
12	Uchi-mata-makikomi	UMM
13	Harai-makikomi	HRM
14	Ko-uchi-makikomi	KUM
15	Kani-basami	KBA/P25
16	Kawazu-gake	KWA/P26

Katame-waza (32)

Osaekomi-waza		
1	Kesa-gatame	KEG
2	Kuzure-kesa-gatame	KKE
3	Ushiro-kesa-gatame	UKG
4	Kata-gatame	KAG
5	Kami-shiho-gatame	KSH
6	Kuzure-kami-shiho-gatame	KKS
7	Yoko-shiho-gatame	YSG
8	Tate-shiho-gatame	TSG
9	Uki-gatame	UGT
10	Ura-gatame	URG

Shime-waza



1	Nami-juji-jime	NJJ
2	Gyaku-juji-jime	GJJ
3	Kata-juji-jime	KJJ
4	Hadaka-jime	HAD
5	Okuri-eri-jime	OEJ
6	Kataha-jime	KHJ
7	Katate-jime	KTJ
8	Ryote-jime	RYJ
9	Sode-guruma-jime	SGJ
10	Tsukkomi-jime	TKJ
11	Sankaku-jime	SAJ
12	Do-jime	DOJ/P08

Kansetsu-waza		
1	Ude-garami	UGR
2	Ude-hishigi-juji-gatame	JGT
3	Ude-hishigi-ude-gatame	UGA
4	Ude-hishigi-hiza-gatame	HIG
5	Ude-hishigi-waki-gatame	WAK/P35
6	Ude-hishigi-hara-gatame	HGA
7	Ude-hishigi-ashi-gatame	AGA
8	Ude-hishigi-te-gatame	TGT
9	Ude-hishigi-sankaku-gatame	SGT
10	Ashi-garami	AGR/P04

H1.3 Penalties

Forbidden Actions



Apply-Technique-Outside	P01
Avoid-Grip	P02
Bend-Opponents-Fingers	P03
Ashi-garami	P04
Defensive-Posture	P05
Disarrange-Judogi	P06
Disregard-Instructions	P07
Dojime	P08
Drive-Into-Mat	P09
Encircling	P10
Fall-Backwards	P11
False-Attack	P12
Fingers-In-Sleeve	P13
Fingers-interlocked	P14
Foot-in-Belt	P15
Outside-Contest-Area	P16
Head-Dive	P17
Hold-Same-Side	P18
Hold-Sleeve-Ends	P19
Hand-On-Face	P20
Hold-Trouser-Leg	P21
Illegal-Joint-Lock	P22
Illegal-Newaza-Entry	P23
Judogi-In-Mouth	P24
Kani-Basami	P25
Kawazu-Gake	P26
Kick-To-Break-Grip	P27
Metallic-Object	P28
Non-Combativity	P29
Reap-Supporting-Leg	P30
Shime-With-Jacket/belt	P31
Spine-Extension	P32
Unnecessary-Remarks	P33
Unsportsmanlike-Conduct	P34



Waki-gatame	P35
Pull down	P36
Pistol Grip	P37
Holding Belt	P38
Kicking	P39
Push out	P40
Undetermined	P99

Others	
Bye	BYE
Fusen Gachi	FUS
Kiken gachi	KIK
Undetermined	UND
Undetermined Katame-waza	UNK
Undetermined Nage-waza	UNN
Yusei Gachi	YUS

Notes



IJF President's Office

HUN 1051 Budapest,
Jozsef Attila str.1

www.ijf.org

IJF General Secretariat

Fédération Française de Judo
21-25 Avenue de la Porte de Châtillon
F-75 680 Paris Cedex 14 France

IJF Lausanne Office

1007 Lausanne
Avenue Frédéric-César-de-La-Harpe 49
Switzerland
www.ijf.org